

Power Products Catalog 2014

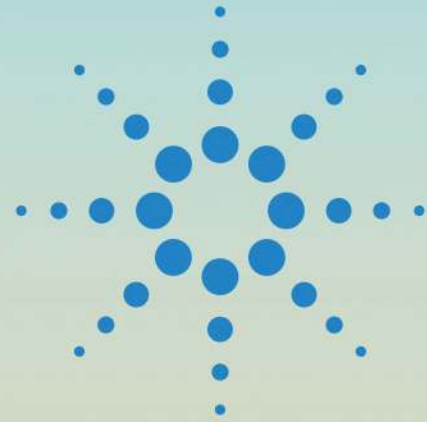

*Detail specifications,
application briefs and more for:*

**DC Power Supplies
DC Electronic Loads
AC Power Solutions**

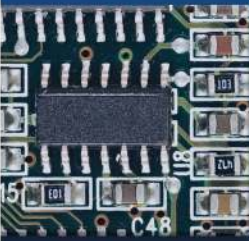

Agilent Technologies

52 NEW High Power DC Supplies from Agilent



Agilent N6900 and N7900

Advanced Power System Family with



Overcome your toughest power test challenges

- 1 kW and 2 kW models (expandable to 10 kW)
- Up to 160 V, up to 200 A
- Increase system throughput (with programming speeds up to 350 μ s)
- Test power storage devices with full two-quadrant operation
- Characterize dynamic current profile (18-bit digitizer)
- Protect high-value DUT with smart triggering

www.agilent.com/find/TestChallenges

Agilent N8900 Series Autoranging System DC Power Supplies

High-power, autoranging output does the job of multiple supplies

- 5 kW, 10 kW and 15 kW models (expandable to >100 kW)
- Up to 1500 V, up to 510 A
- Autoranging output – like many power supplies in one!
- Protection from over-voltage, over-current and over-temperature
- Just the right amount of performance, at just the right price



www.agilent.com/find/N8900

Solutions

to match your new test and measurement challenges. Choosing from over 200 models of power supplies with confidence. Because Agilent knows how to make power products.



One quick browse through this catalog will convince you that Agilent power products offer so much more than simple power generation. In each power product category, we've integrated the capabilities you need for a complete solution. Agilent Technologies' broad selection of both bench-friendly and system-ready instruments can meet your testing challenges – from basic to complex – with a wealth of available capabilities. With over 40 years of leadership in power test solutions, Agilent continues to introduce a variety of dependable products to help you decrease your test time and speed design validation.

This catalog includes easy to use selection guides for each power product category to help you select the best power supply for your application. For the most comprehensive product information, we've provided a unique URL to each product's website where you can find data sheets and application notes, download drivers, and view videos and interactive demos.

Products you can count on year after year

We've been a leader in the power and measurement business for more than four decades because engineers like you know they can count on Agilent performance and reliability. We specify and guarantee performance for the entire integrated system, so you know what you're really dealing with—unlike the typical “rack-and-stack” setup. Plus, every Agilent product in this catalog has a global warranty.

We know you have more important things to do than shop around for power products. That's why we've made such a wide range of products available through Agilent. The experienced engineers at Agilent can help you select just the right solutions for your application and your budget, then arrange fast shipping so you can get to work in a hurry.

New

Products

N6900/N7900 Series Advanced Power System



N6900/N7900 Series Advanced Power System

The Advanced Power System (APS) family consists of 1 kW and 2 kW system DC power supplies that deliver a new level in power supply performance enabled by Agilent's exclusive VersaPower architecture. The APS family was designed to help you overcome your toughest power test challenges by delivering industry-leading specifications and innovative features in an integrated solution for advanced automated test equipment (ATE) power testing needs.

VersaPower architecture delivers the fastest, most accurate, integrated power system:

- Accelerate test-system throughput with industry-leading speed
- Capture your DUT's current profile with accurate measurements
- Reduce your ATE development time and cost with highly integrated capabilities

APS N6900 Series DC Power Supplies are designed for ATE applications where high performance is critical.

APS N7900 Series Dynamic DC Power Supplies are designed for ATE applications where high-speed dynamic sourcing and measurement are needed.

Two power ranges deliver a large amount of power in a small test-system footprint:

- 1 kW models have a 1U full-rack footprint
- 2 kW models have a 2U full-rack footprint
- Built-in paralleling capability up to 10 kW

See Page 63

N8900 Series Autoranging System DC Power Supplies



N8900 Series Autoranging System DC Power Supplies

The Agilent Technologies N8900 Series provides 5, 10, and 15 kW autoranging, single-output programmable DC power for ATE applications that require just the right amount of performance at just the right price. The N8900 Series power supplies' autoranging output characteristic enables unprecedented flexibility by offering a wide range of voltage and current combinations at full power. Power supplies with "rectangular," or traditional, output characteristics provide full power at only one voltage and current combination. Just one N8900 does the job of multiple power supplies. It's like having many power supplies in one!

The N8900 Series provides stable output power, built-in voltage and current measurements, and autoranging output voltage and current from 80 to 1500 V and 10 to 510 A. These supplies offer many system-ready features like multiple standard I/O interfaces to simplify and accelerate test-system development and compact 3U design to save rack space. If more power is required, easily parallel multiple N8900 units to create "one" power supply with > 100 kW of total output power. The built-in master/slave control enables programming as if it's just one big power supply; no need to program each supply individually.

See Page 37

New

Products (continued)

B2900A Series Precision Source/Measure Unit



B2961A/62A 6.5 Digit Low Noise Power Source

The Agilent B2961A/B2962A 6.5 Digit Low Noise Power Source is an advanced low cost power supply/source offering 6.5 digit best-in-class precision, wide and bipolar (4-quadrant) output ranges of 100 nV-210 V/10 fA-3 A (DC)/10.5 A (pulsed) and extremely low noise of 10 μVrms and 1 $\text{nVrms}/\sqrt{\text{Hz}}$ (at 10 kHz). It also offers other innovative features such as graphing capability and arbitrary waveform generating capability (1 mHz-10 kHz), which allow tests and evaluation that conventional power supply/sources cannot do.

See Page 94

Table of Contents

New Products	III-IV
DC Power Supply Selection Index	2-10
DC Power Supply Feature Description Index	11-14
<hr/>	
Basic DC Power Supplies...essential features for a tight budget	15
Single & Triple Output: 90-375 W	16-17
Multiple-Output: 35 and 50 W	18
Triple-Output: 80 W GPIB	19
Single-Output: 120-200 W GPIB	20-21
Single & Dual Output: 30-100 W GPIB	22-23
Autoranging: 200-1000 W GPIB, 5000 W-15000 W GPIB, LAN, USB	24-26, 37-43
Single Output: 750 W & 1500 W, 3300 W & 5000 W GPIB, LAN, USB	27-36
<hr/>	
High Performance DC Power Supplies...speed and accuracy for test optimization	44
Single-Output: 40-500 W GPIB	45-51, 55-58
Single-Output: 200-500 W	52-54, 59-62
Single-Output: 1000 W & 2000 W GPIB, LAN, USB & 2000 W GPIB	63-78, 79-85
Single-Output: 2000 W	86-89
Single-Output: 5000 W GPIB	90-91
Single-Output: 6600 W GPIB	92-93
Multiple-Output: 40-105 W GPIB	97-98
Precision Multiple-Output: 25-50 W GPIB	94-96, 99-100
Low-Profile Modular Power System: 20-500 W GPIB, LAN, USB	101-113
Modular Power System: 1200 W per Mainframe GPIB	114-117
DC Power Analyzer, Modular: 600 W GPIB, LAN, USB, LXI Core	118-120
<hr/>	
Application Specific DC Power Supplies...tailored solutions for specific needs	21
Mobile Communications DC Sources	122-131
Solar Array Simulators	132-136
Source Measure Units	137-153
Device Analyzer/Curve Tracers	154-157
<hr/>	
DC Electronic Loads...maximize throughput with real life loading conditions	158
Multiple-Input Electronic Loads	159-165
Single-Input Electronic Loads	166-169
<hr/>	
AC Power Source/Analyzers...an integrated AC power solution	170
AC Power Source/Analyzers: 375-1750 VA	171-178
Power Products AC Line Voltage and Cord Options	179-185
Power Products Applications Information	186-204
Model Number Index	205-207
Replacement Guide	208-209

More detailed specifications at www.agilent.com/find/power

DC Power Supply Selection Index

Maximum volts	Maximum amps	Maximum watts	Number of outputs	GPIB	Model number	Type	Page number
3	300	900	1	*	6671A-J08	Performance	80
3.3	1000	3300	1	*	6680A-J04	Performance	90
5	10	50	up to 4	*	N6731B	Basic	110, 118
5	20	100	up to 4	*	N6741B	Basic	112, 118
5	875	4400	1	*	6680A	Performance	90
5.7	20	100	up to 8	*	66101A-J03	Performance	115
6	2.5	15	3		E3630A	Basic	18
6	3	18	up to 4	*	N6783A-MFG	Basic	122
6	5	30	3	*	E3631A	Basic	19
6	60	360	1	*	6551A-J03	Performance	60
6	60	360	1	*	6651A-J03	Performance	56
6	100	600	1	*	N5741A	Basic	27
6	180	1080	1	*	N5761A	Basic	30
6.7	30	200	1	*	6033A	Autoranging	24
7	0.015	0.11	2	*	6625A	Performance	99
7	0.015	0.11	4	*	6626A	Performance	99
7	5	35	3	*	6623A	Performance	97
7	5	35	4	*	6624A	Performance	97
7	10	70	2	*	6621A	Performance	97
7	10	70	3	*	6623A	Performance	97
7	120	1000	1	*	6031A	Autoranging	24
8	3	24	1	*	E3640A	Basic	22
8	3	24	2	*	E3646A	Basic	23
8	3	24	up to 4	*	N6783A-BAT	Basic	119, 122
8	5	40	1	*	6611C	Performance	45
8	5	40	1	*	E3642A	Basic	22
8	5	40	2	*	E3648A	Basic	23
8	6.25	50	up to 4	*	N6732B	Basic	110, 118
8	8	80	1	*	E3644A	Basic	22
8	10	80	1	*	6631B	Performance	47
8	12.5	100	up to 4	*	N6742B	Basic	112, 118
8	16	128	up to 8	*	66101A	Performance	114
8	20	160	1		6541A	Performance	52
8	20	160	1	*	6641A	Performance	49

More detailed specifications at www.agilent.com/find/power

DC Power Supply Selection Index (Continued)

Maximum volts	Maximum amps	Maximum watts	Number of outputs	GPIB	Model number	Type	Page number
8	20	160	1	*	E3633A	Basic	20
8	50	400	1		6551A	Performance	59
8	50	400	1	*	6651A	Performance	55
8	90	720	1	*	N5742A	Basic	27
8	165	1320	1	*	N5762A	Basic	30
8	220	1760	1		6571A	Performance	86
8	220	1760	1	*	6671A	Performance	79
8	400	3200	1	*	N8731A	Basic	32
8	580	4600	1	*	6681A	Performance	90
9	100	900	1	*	N6950A	Performance	63
9	100	900	1	*	N7950A	Performance	69
9	200	1800	1	*	N6970A	Performance	67
9	200	1800	1	*	N7970A	Performance	72
10	5	50	1	*	6611C-J05	Performance	45
10	50	500	1		6551A-J01	Performance	60
10	50	500	1	*	6651A-J01	Performance	55
10	200	2000	1		6571A-J04	Performance	87
10	200	2000	1	*	6671A-J04	Performance	80
10	330	3300	1	*	N8732A	Basic	32
12	1.5	18	2	*	66309B	Mobile communications	125
12	1.5	18	2	*	66309D	Mobile communications	125
12	1.5	18	2	*	66319B	Mobile communications	125
12	1.5	18	2	*	66319D	Mobile communications	125
12	12	150	up to 8	*	66101A-J05	Performance	115
12.5	60	750	1	*	N5743A	Basic	27
12.5	120	1500	1	*	N5763A	Basic	30
13	15.3	200	1		6541A-J04	Performance	53
13	15.3	200	1	*	6641A-J04	Performance	50
14	150	2000	1		6571A-J03	Performance	86
14	150	2000	1	*	6671A-J03	Performance	80
15	3	45	2	*	66309B	Mobile communications	125
15	3	45	2	*	66309D	Mobile communications	125
15	3	45	1	*	66311B	Mobile communications	125
15	3	45	2	*	66319B	Mobile communications	125
15	3	45	2	*	66319D	Mobile communications	125
15	3	45	2	*	66321B	Mobile communications	125
15	3	45	2	*	66321D	Mobile communications	125

More detailed specifications at www.agilent.com/find/power

DC Power Supply Selection Index (Continued)

Maximum volts	Maximum amps	Maximum watts	Number of outputs	GPIB	Model number	Type	Page number
15	7	105	1	*	E3632A	Basic	20
15	10	150	up to 8	*	66102A-J05	Performance	115
15	120	1800	1		6571A-J17	Performance	87
15	120	1800	1	*	6671A-J17	Performance	80
15	220	3300	1	*	N8733A	Basic	32
15	440	6600	1	*	6690A	Performance	92
16	0.2	3.2	2	*	6625A	Performance	99
16	0.2	3.2	4	*	6626A	Performance	99
16	0.2	3.2	2	*	6628A	Performance	99
16	0.2	3.2	4	*	6629A	Performance	99
17	30	510	1	*	6651A-J09	Performance	56
20	0.12	2.4	1		U2722A	Source measure unit	142
20	0.12	2.4	1		U2723A	Source measure unit	142
20	0.5	10	3		E3630A	Basic	18
20	1.5	30	1	*	E3640A	Basic	22
20	1.5	30	2	*	E3646A	Basic	23
20	2	40	1	*	6612C	Performance	45
20	2	40	3	*	6623A	Performance	97
20	2	40	4	*	6624A	Performance	97
20	2	40	4	*	6627A	Performance	97
20	2.5	50	1	*	E3642A	Basic	22
20	2.5	50	2	*	E3648A	Basic	23
20	2.5	50	up to 4	*	N6733B	Basic	110, 118
20	3	20	up to 4	*	N6781A	Source measure unit	119, 137
20	3	20	up to 4	*	N6782A	Source measure unit	119, 137
20	3	20	up to 4	*	N6784A	Source measure unit	119, 137
20	4	80	2	*	6621A	Performance	97
20	4	80	2	*	6622A	Performance	97
20	4	80	3	*	6623A	Performance	97
20	4	80	1	*	E3644A	Basic	22
20	5	100	1	*	6632B	Performance	47
20	5	100	1	*	66332A	Mobile communications	125
20	5	100	up to 4	*	N6743B	Basic	112, 118
20	7.5	150	up to 8	*	66102A	Performance	114
20	10	200	1	*	6033A	Autoranging	24
20	10	200	1	*	6038A	Autoranging	24
20	10	200	1		6542A	Performance	52
20	10	200	1	*	6642A	Performance	49
20	10	200	1	*	E3633A	Basic	20
20	15	300	1	*	6651A-J09	Performance	56

More detailed specifications at www.agilent.com/find/power

DC Power Supply Selection Index (Continued)

Maximum volts	Maximum amps	Maximum watts	Number of outputs	GPIB	Model number	Type	Page number
20	15	300	up to 4	*	N6773A	Basic	108, 118
20	25	500	1		6552A	Performance	59
20	25	500	1	*	6652A	Performance	55
20	38	760	1	*	N5744A	Basic	27
20	50	300	up to 2	*	N6753A	Performance	101, 118
20	50	300	up to 2	*	N6763A	Performance	104, 119
20	50	500	up to 2	*	N6755A	Performance	101, 118
20	50	500	up to 2	*	N6765A	Performance	104, 119
20	50	1000	1	*	6031A	Autoranging	24
20	50	1000	1	*	6032A	Autoranging	24
20	50	1000	1	*	N6951A	Performance	63
20	50	1000	1	*	N7951A	Performance	69
20	76	1520	1	*	N5764A	Basic	30
20	100	2000	1		6572A	Performance	86
20	100	2000	1	*	6672A	Performance	79
20	100	2000	1	*	N6971A	Performance	66
20	100	2000	1	*	N7971A	Performance	72
20	165	3300	1	*	N8734A	Basic	32
20	250	5000	1	*	N8754A	Basic	35
21	240	5000	1	*	6682A	Performance	90
24	6	100	up to 8	*	66103A-J12	Performance	116
24	85	2000	1	*	6672A-J04	Performance	80
25	1	25	2		E3620A	Basic	18
25	1	25	3	*	E3631A	Basic	19
25	7	175	1	*	E3634A	Basic	20
27	20	540	1	*	6652A-J03	Performance	56
28	5	140	up to 8	*	66103A-J09	Performance	116
30	3	90	1		U8001A	Basic	16
30	3.3	100	1	*	66332A-J01	Mobile communications	125
30	4	120	1	*	E3632A	Basic	20
30	5	150	1		U8002A	Basic	16
30	6	180	3		U8031A	Basic	16
30	17.5	500	1	*	6653A-J17	Performance	56
30	17.5	525	1		6553A-J17	Performance	60
30	25	750	1	*	N5745A	Basic	27
30	50	1500	1	*	N5765A	Basic	30
30	110	3300	1	*	N8735A	Basic	32
30	170	5100	1	*	N8755A	Basic	35
30	220	6600	1	*	6691A	Performance	92
32	160	5100	1	*	6683A	Performance	90
35	0.8	28	1	*	E3641A	Basic	22
35	0.8	28	2	*	E3647A	Basic	23
35	1.25	40	up to 8	*	66105A-J01	Performance	116
35	1.4	49	1	*	E3643A	Basic	22

More detailed specifications at www.agilent.com/find/power

DC Power Supply Selection Index (Continued)

Maximum volts	Maximum amps	Maximum watts	Number of outputs	GPIB	Model number	Type	Page number
35	1.4	49	2	*	E3649A	Basic	23
35	1.5	50	up to 4	*	N6734B	Basic	110, 118
35	2.2	80	1	*	E3645A	Basic	23
35	3	80	3	*	6623A-J03	Performance	97
35	3	100	up to 4	*	N6744B	Basic	112, 118
35	4.5	150	up to 8	*	66103A	Performance	114
35	6	210	1	*	6543A	Performance	52
35	6	210	1	*	6643A	Performance	49
35	8.5	300	up to 4	*	N6774A	Basic	108, 118
35	15	525	1	*	6553A	Performance	59
35	15	525	1	*	6653A	Performance	55
35	60	2100	1	*	6573A	Performance	86
35	60	2100	1	*	6673A	Performance	79
37	4	150	up to 8	*	66103A-J01	Performance	115
37.5	45	1690	1	*	6573A-J03	Performance	87
37.5	45	1690	1	*	6673A-J03	Performance	80
40	3.6	100	up to 8	*	66103A-J02	Performance	115
40	5	200	1	*	6643A-J11	Performance	50
40	12.5	500	1	*	6553A-J04	Performance	60
40	12.5	500	1	*	6653A-J04	Performance	56
40	19	760	1	*	N5746A	Basic	27
40	25	1000	1	*	N6952A	Performance	63
40	25	1000	1	*	N7952A	Performance	69
40	38	1520	1	*	N5766A	Basic	30
40	50	2000	1	*	6573A-J08	Performance	87
40	50	2000	1	*	6673A-J08	Performance	81
40	50	2000	1	*	N6972A	Performance	66
40	50	2000	1	*	N7972A	Performance	72
40	85	3400	1	*	N8736A	Basic	32
40	125	5000	1	*	N8756A	Basic	35
40	128	5100	1	*	6684A	Performance	90
50	0.5	25	2	*	6625A	Performance	99
50	0.5	25	4	*	6626A	Performance	99
50	0.8	40	3	*	6623A	Performance	97
50	0.8	40	4	*	6624A	Performance	97
50	0.8	40	4	*	6627A	Performance	97
50	1	50	1	*	6613C	Performance	45
50	1	50	2	*	6625A	Performance	99
50	1	50	4	*	6626A	Performance	99
50	1	50	2	*	6628A	Performance	99
50	1	50	4	*	6629A	Performance	99
50	1.5	50	up to 4	*	N6761A	Performance	104, 119
50	2	80	2	*	6622A	Performance	97
50	2	100	1	*	6633B	Performance	47
50	3	100	up to 4	*	N6762A	Performance	104, 119

More detailed specifications at www.agilent.com/find/power

DC Power Supply Selection Index (Continued)

Maximum volts	Maximum amps	Maximum watts	Number of outputs	GPIB	Model number	Type	Page number
50	4	200	1	*	E3634A	Basic	20
50	5	50	up to 4	*	N6751A	Performance	101, 118
50	10	100	up to 4	*	N6752A	Performance	101, 118
50	10	500	1	*	6554A-J05	Performance	61
50	10	500	1	*	6654A-J05	Performance	57
50	42	2000	1	*	6574A-J07	Performance	87
50	42	2000	1	*	6674A-J07	Performance	81
55	3	165	1	*	66104A-J09	Performance	116
56	38	2000	1	*	6574A-J03	Performance	87
56	38	2000	1	*	6674A-J03	Performance	81
58	9.3	497.6	up to 2	*	E4361A-J01	Solar array simulator	132
60	0.5	30	1	*	E3641A	Basic	22
60	0.5	30	2	*	E3647A	Basic	23
60	0.8	48	1	*	E3643A	Basic	22
60	0.8	48	2	*	E3649A	Basic	23
60	0.8	50	up to 4	*	N6735B	Basic	110, 118
60	1.3	80	1	*	E3645A	Basic	23
60	1.6	100	up to 4	*	N6745B	Basic	112, 118
60	2.5	150	up to 8	*	66104A	Performance	114
60	3	180	3	*	U8032A	Basic	16
60	3.3	200	1	*	6038A	Autoranging	24
60	3.5	210	1	*	6544A	Performance	52
60	3.5	210	1	*	6644A	Performance	49
60	5	300	up to 4	*	N6775A	Basic	108, 118
60	9	540	1	*	6554A	Performance	59
60	9	540	1	*	6654A	Performance	55
60	12.5	750	1	*	N5747A	Basic	29
60	16.7	1000	1	*	N6953A	Performance	63
60	16.7	1000	1	*	N7953A	Performance	69
60	17	500	up to 2	*	N6756A	Performance	101, 118
60	17	500	up to 2	*	N6766A	Performance	104, 119
60	17	1200	1	*	6030A	Autoranging	24
60	17.5	1200	1	*	6032A	Autoranging	24
60	20	300	up to 2	*	N6754A	Performance	101, 118
60	20	300	up to 2	*	N6764A	Performance	104, 119
60	25	1500	1	*	N5767A	Basic	31
60	33.3	2000	1	*	N6973A	Performance	66
60	33.3	2000	1	*	N7973A	Performance	72
60	35	2100	1	*	6574A	Performance	86
60	35	2100	1	*	6674A	Performance	79
60	55	3300	1	*	N8737A	Basic	34
60	85	5100	1	*	N8757A	Basic	35
60	110	6600	1	*	6692A	Performance	92

More detailed specifications at www.agilent.com/find/power

DC Power Supply Selection Index (Continued)

Maximum volts	Maximum amps	Maximum watts	Number of outputs	GPIB	Model number	Type	Page number
65	8.5	510	up to 2	*	E4361A	Solar array simulator	132
70	3	200	1		6544A-J09	Performance	53
70	3	200	1	*	6644A-J09	Performance	50
70	7.5	500	1		6554A-J04	Performance	61
70	7.5	500	1	*	6654A-J04	Performance	57
70	30	2000	1	*	E4356A	Telecom	84
80	6	480	1		6554A-J12	Performance	61
80	6	500	1	*	6654A-J12	Performance	57
80	9.5	760	1	*	N5748A	Basic	29
80	12.5	1000	1	*	N6954A	Performance	63
80	12.5	1000	1	*	N7954A	Performance	69
80	19	1520	1	*	N5768A	Basic	31
80	25	2000	1	*	N6974A	Performance	66
80	25	2000	1	*	N7974A	Performance	72
80	26	2000	1	*	E4356A	Telecom	84
80	42	3360	1	*	N8738A	Basic	34
80	65	5200	1	*	N8758A	Basic	35
80	170	5000	1	*	N8920A	Autoranging	37
80	170	5000	1	*	N8940A	Autoranging	37
80	340	10000	1	*	N8925A	Autoranging	39
80	340	10000	1	*	N8945A	Autoranging	39
80	510	15000	1	*	N8931A	Autoranging	41
80	510	15000	1	*	N8951A	Autoranging	41
100	0.5	50	1	*	6614C	Performance	45
100	0.5	50	up to 4	*	N6736B	Basic	110, 118
100	1	100	1	*	6634B	Performance	47
100	1	100	up to 4	*	N6746B	Basic	112, 118
100	2.2	200	up to 2	*	E5262A	Source measure unit	148
100	3	300	up to 4	*	N6776A	Basic	108, 118
100	7.5	750	1	*	N5749A	Basic	29
100	15	1500	1	*	N5769A	Basic	31
100	22	2000	1	*	6675A-J08	Performance	82
100	33	3300	1	*	N8739A	Basic	34
100	50	5000	1	*	N8759A	Basic	36
110	20	2000	1		6575A-J09	Performance	88
110	20	2000	1	*	6675A-J09	Performance	82
117	5.5	594	up to 2	*	E4362A-J01	Solar array simulator	132
120	1.25	150	up to 8	*	66105A	Performance	114
120	1.5	180	1		6545A	Performance	52
120	1.5	180	1	*	6645A	Performance	49
120	4	540	1	*	6655A	Performance	55
120	4.5	540	1		6555A	Performance	59

More detailed specifications at www.agilent.com/find/power

DC Power Supply Selection Index (Continued)

Maximum volts	Maximum amps	Maximum watts	Number of outputs	GPIB	Model number	Type	Page number
120	5.4	594	up to 2	*	E4362A-J02	Solar array simulator	132
120	16.7	2000	1	*	N6976A	Performance	75
120	16.7	2000	1	*	N7976A	Performance	75
120	18	2160	1	*	6575A	Performance	86
120	18	2160	1	*	6675A	Performance	79
130	5	600	up to 2	*	E4362A	Solar array simulator	132
135	16	2000	1	*	6575A-J06	Performance	88
135	16	2000	1	*	6675A-J06	Performance	81
150	2	300	up to 4	*	N6777A	Basic	108, 118
150	1.2	150	1	*	6545A-J05	Performance	53
150	1.2	150	1	*	6645A-J05	Performance	50
150	3.2	500	1	*	6655A-J05	Performance	57
150	5	750	1	*	N5750A	Basic	29
150	10	1500	1	*	N5770A	Basic	31
150	15	2000	1	*	6675A-J11	Performance	82
150	15	2250	1	*	6575A-J11	Performance	88
150	22	3300	1	*	N8740A	Basic	34
150	34	5100	1	*	N8760A	Basic	36
156	3	500	1	*	6555A-J10	Performance	61
156	3	500	1	*	6655A-J10	Performance	57
160	12.5	2000	1	*	N6977A	Performance	75
160	12.5	2000	1	*	N7977A	Performance	75
160	13	2000	1	*	6575A-J04	Performance	88
160	13	2000	1	*	6675A-J04	Performance	81
170	1	170	1	*	6645A-J06	Performance	50
200	0.75	150	up to 8	*	66106A	Performance	114
200	2.2	200	up to 2	*	E5263A	Source measure unit	150
200	4	200	up to 8	*	E5260A	Source measure unit	146
200	4	200	up to 8	*	E5270B	Source measure unit	152
200	4.2	200	up to 10	*	B1500A	Device analyzer/ curve tracer	154
200	5	1000	1	*	6035A	Autoranging	24
200	5	1200	1	*	6030A	Autoranging	24
200	11	2000	1	*	6575A-J07	Performance	88
200	11	2000	1	*	6675A-J07	Performance	82
200	70	5000	1	*	N8921A	Autoranging	37
200	70	5000	1	*	N8941A	Autoranging	37
200	140	10000	1	*	N8926A	Autoranging	39
200	140	10000	1	*	N8946A	Autoranging	39
200	210	15000	1	*	N8932A	Autoranging	41
200	210	15000	1	*	N8952A	Autoranging	41

More detailed specifications at www.agilent.com/find/power

DC Power Supply Selection Index (Continued)

Maximum volts	Maximum amps	Maximum watts	Number of outputs	GPIB	Model number	Type	Page number
210	3.03	31.8	1	*	B2901A	Source measure unit	140
210	3.03	31.8	2	*	B2902A	Source measure unit	140
210	3.03	31.8	1	*	B2911A	Source measure unit	140
210	3.03	31.8	2	*	B2912A	Source measure unit	140
210	3.03	31.8	1	*	B2961A	Source measure unit	94
210	3.03	31.8	2	*	B2962A	Source measure unit	94
300	2.5	750	1	*	N5751A	Basic	29
300	5	1500	1	*	N5771A	Basic	31
300	11	3300	1	*	N8741A	Basic	34
300	17	5100	1	*	N8761A	Basic	36
500	2	1000	1	*	6035A	Autoranging	24
500	30	5000	1	*	N8923A	Autoranging	37
500	30	5000	1	*	N8943A	Autoranging	37
500	60	10000	1	*	N8928A	Autoranging	39
500	60	10000	1	*	N8948A	Autoranging	39
500	90	15000	1	*	N8934A	Autoranging	41
500	90	15000	1	*	N8954A	Autoranging	41
600	1.3	780	1	*	N5752A	Basic	29
600	2.6	1560	1	*	N5772A	Basic	31
600	5.5	3300	1	*	N8742A	Basic	34
600	8.5	5100	1	*	N8762A	Basic	36
750	20	5000	1	*	N8924A	Autoranging	37
750	20	5000	1	*	N8944A	Autoranging	37
750	30	10000	1	*	N8929A	Autoranging	39
750	30	10000	1	*	N8949A	Autoranging	39
750	60	15000	1	*	N8935A	Autoranging	41
750	60	15000	1	*	N8955A	Autoranging	41
1500	30	15000	1	*	N8937A	Autoranging	41
1500	30	15000	1	*	N8957A	Autoranging	41

More detailed specifications at www.agilent.com/find/power

DC Power Supply Feature Description Index

		<div style="display: flex; justify-content: space-between; padding: 5px;"> 6030 & N8900 Series Autorangers 6630 Series Single-Output 6620 Series Multiple-Output 6640 & 6650 Precision Multiple-Output N6900/7900, 6670-6690 Series Single-Output 66000 Modular Power Systems 66300 Series Mobile Communications N5700 & E3640 Series Single & Multiple-Output N6700 Modular Power System Family </div>											
DC range	Max power	200 W-15 kW	40 W-100 W	40 W & 80 W	25 W & 50 W	200 W-500 W	1000 W-6600 W	1200 W	40 W-100 W	30 W-200 W	700 W-5000 W	20 W-500 W	
	Max voltage	1500 V	100 V	50 V	50 V	120 V	160 V	200 V	20 V	60 V	600 V	150 V	
	Max current	510 A	10 A	10 A	2 A	50 A	875 A	16 A	5 A	20 A	400 A	50 A	
	Page	24, 37	47	97	99	49, 55	63, 79, 90	114	125	20, 22	27, 32	101	
Configuration Features													
"One-box" solution To preserve rack space and interconnections, the voltage and current programmers, current shunt, and DVM are built-in to one package.		•	•	•	•	•	•	•	•	•	•	•	
Modular power system (multiple reconfigurable outputs) Modules can be installed into a mainframe, and configuration can be changed at any time.									• Up to 8			• Up to 4	
Multiple non-reconfigurable outputs Up to four outputs are included in one package, and they share one GPIB address.				•	•					66309 B/D 66319 B/D	•		
Serial link Up to 16 power supply outputs can share one GPIB address when connected with a telephone style cable.		•				•	6670-6690	•					
Relay connect, disconnect, & polarity reversal Optionally integrated with the power supply							N7900 Non-rev N7950A N7970A	•	•	66332A Only	•	• Module dependent	
Auto-parallel, auto-series, parallel, and series operation When connected in auto-parallel or auto-series, only one unit has to be programmed to take advantage of the full power from all. AP=auto-parallel AS=auto-series S=series P=parallel		S AP		S P up to 2 identical outputs	S P up to 2 identical outputs	S AP	S AP	S, P		S, P	•	•	
Analog programming and monitoring ports Analog programming ports allow the power supply to be used as a power amplifier, responding to an external voltage signal. Monitoring ports allow an external DMM to monitor the power-supply outputs.		•				•	•				•		



For more detailed specifications see the product manual at www.agilent.com/find/power

DC Power Supply Feature Description Index (Continued)

6030 & N8900 Series Autorangers
6630 Series Single-Output
6620 Series Multiple-Output
6620 Series Precision Multiple-Output
6640 & 6650 Series Single-Output
N6900/7900, 6670-6690 Series Single-Output
66000 Modular Power Systems
66300 Series Mobile Communications
E3630 & E3640 Series Single & Multiple-Output
N5700 & N8700 Series Single-Output
N6700 Modular Power System Family

DC range	Max power	200 W- 15 kW	40 W- 100 W	40 W & 80 W	25 W & 50 W	200 W- 500 W	1000 W- 6600 W	1200 W	40 W- 100 W	30 W- 200 W	700 W- 5000 W	20 W- 500 W
	Max voltage	1500 V	100 V	50 V	50 V	120 V	160 V	200 V	20 V	60 V	600 V	150 V
	Max current	510 A	10 A	10 A	2 A	50 A	875 A	16 A	5 A	20 A	400 A	50 A
	Page	24, 37	47	97	99	49, 55	63, 79, 90	114	125	20, 22	27, 32	101

Output Voltage and Current Range Changing

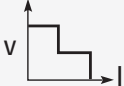
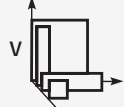
<p>Single range The output voltage is limited by a single maximum value. The output current is limited by a single maximum value.</p> 		•				•	•	•			•	•
<p>Single range + peak current pulse A limited amplitude and limited width current pulse can be sourced beyond the maximum static current limit.</p> 										•		
<p>Auto-ranging A wide, continuous range of voltage and current combinations are available automatically at the maximum power level.</p> 		•										•
<p>Multiple-output range changing Automatic range changing gives maximum power to two different voltage and current combinations.</p> 				•	•							•
<p>Precision multiple-output range changing Voltage and current ranges can be chosen independently to provide greater resolution.</p> 					•							•

Performance Characteristics

Output ripple and noise (Peak-to-peak, 20 Hz to 20 MHz)	30-160 mV 6030 200 mV - 1 V N8900	3 mV (10 mV to 25 mV in fast mode)	3 mV	3 mV	3 mV- 7 mV	7 mV- 30 mV	5-50 mV	3-10 mV	2-5 mV	60- 500 mV	**
Output programming response time Rise and fall time with full resistive load (10 to 90% and 90 to 10%) Does not include command processing time.	***	2 ms (0.4 ms in fast mode)	2-6 ms	6 ms	15 ms	0.35 ms- 3 ms N69/7900 9 ms- 195 ms N6670-90	20 ms- 50 ms	0.4 ms- 2 ms	11 ms- 95 ms	0.08 s to 0.50 s	*
Programming resolution (percent of full scale)	0.025%	0.025%	0.03%	0.007%	0.025%	0.002%- 0.025%	0.03%	0.025%	0.025%/ 0.007%	*	*

* See datasheet or user's guide for complete details

** N6750/N6760: 4.5 mVpp to 6 mVpp, N6770: 20 mVpp to 68 mVpp, N6780: 8 mVpp to 12 mVpp, N6730/N6740: 10 mVpp to 30 mVpp

*** 6033A & 6038A: (100 ms-200 ms), 6030A-6032A & 6035A: (300 ms-2000 ms), N8900: (≤14 ms rise, ≤39 ms fall)

For more detailed specifications see the product manual at www.agilent.com/find/power

DC Power Supply Feature Description Index (Continued)

6030 & N8900 Series Autorangers
 6630 Series Single-Output
 6620 Series Multiple-Output
 6640 & 6650 Series Precision Multiple-Output
 N6900/7900, 6670, 6690 Series Single-Output
 66000 Modular Power Systems
 66300 Series Mobile Systems
 E3630 & E3640 Series Mobile Communications
 N5700 & N8700 Series Single & Multiple-Output
 N6700 Modular Power System Family

DC range	Max power	200 W-15 kW	40 W-100 W	40 W & 80 W	25 W & 50 W	200 W-500 W	1000 W-6600 W	1200 W	40 W-100 W	30 W-200 W	700 W-5000 W	20 W-500 W
	Max voltage	1500 V	100 V	50 V	50 V	120 V	160 V	200 V	20 V	60 V	600 V	150 V
	Max current	510 A	10 A	10 A	2 A	50 A	875 A	16 A	5 A	20 A	400 A	50 A
	Page	24, 37	47	97	99	49, 55	63, 79, 90	114	125	20, 22	27, 32	101

GPIO Programming Features

GPIO programming of voltage and current Self-documenting programming commands mean that programming is done in units of volts and amps, not in percentages or binary representations.	•	•	•	•	•	•	•	•	•	•	•	•
Measured voltage and current read-back over the GPIO The output is read back in units of volts and amps.	•	•	•	•	•	•	•	•	•	•	•	•
Store-recall states Complete operating states can be stored in nonvolatile memory. Each state specifies not only the output voltage and current, but also many of the programmable protection features.												
Number nonvolatile states (One of these states is automatically accessed on turn-on)	10 N8900	4	0	4	5	*	5	4	E363x-3 E364x-5	1	2	
Number volatile states	16/5 6030	0	10	7	0	0	5	0	0	16	0	
Standard Commands for Programmable Instruments (SCPI) SCPI is the standard language for test and measurement equipment. Standard codes make a software writing and maintenance more efficient. For example, using this standard, the output voltage of the power supply is measured with the same command (MEASURE: VOLTAGE?) by either a DMM or a power supply.	•	•			•	•	•	•	•	•	•	•

Protection Features

GPIO programmable overvoltage protection Can be enabled to quickly down-program the output and set SRQ and/or DFI/RI. T = Can generate trigger. M = Overvoltage, the level is set manually with a front-panel control.	M 6030 • N8900	•	T	T	•	•	T	•	•	T M	T	
GPIO programmable overcurrent protection Can be enabled to quickly down-program the output and set SRQ and/or DFI/RI. T = Can generate trigger.	•	•	•	•	•	•	T	•	E3632A E3633A E3634A	T	T	
Overtemperature protection Will down-program the output and can be enabled to set SRQ and/or DFI. T = Can generate trigger.	•	•	•	•	•	•	T	•		T	T	

* N6900 & N7900: 10, 6670: 5, 6680: 4, 6690: 4

DC Power Supply Feature Description Index (Continued)

6030 & N8900 Series Autorangers
 6630 Series Single-Output
 6620 Series Multiple-Output
 6640 & 6650 Series Precision Multiple-Output
 N6900/7900, 6670-6690 Series Single-Output
 66000 Modular Power Systems
 66300 Series Mobile Communications
 E3630 & E3640 Series Single & Multiple-Output
 N5700 & N8700 Series Single-Output
 N6700 Modular Power System Family

DC range	Max power	200 W-15 kW	40 W-100 W	40 W & 80 W	25 W & 50 W	200 W-500 W	1000 W-6600 W	1200 W	40 W-100 W	30 W-200 W	700 W-5000 W	20 W-500 W
	Max voltage	1500 V	100 V	50 V	50 V	120 V	160 V	200 V	20 V	60 V	600 V	150 V
	Max current	510 A	10 A	10 A	2 A	50 A	875 A	16 A	5 A	20 A	400 A	50 A
	Page	24, 37	47	97	99	49, 55	63, 79, 90	114	125	20, 22	27, 32	101

Protection Features (Continued)

Discrete fault indicator/remote inhibit (DFI/RI) Using these digital ports, power supplies can be connected independently of the GPIB. If any one experiences an error condition (overvoltage, for example), it can signal the other units to also downprogram their outputs. O = Optional	6030	•	O	O	•	•	•	•	•	•	•	•
SRQ Almost any fault condition or change of state of the power supply can be enabled to generate an SRQ. This signals the computer to take the appropriate action.	•	•	•	•	•	•	•	•	•	•	•	•
Local lockout Front-panel or keyboard control can be disabled. This keeps unauthorized operators from changing the programmed states.	•	•	•	•	•	•	•	•	•	•	•	•
Fan-speed control Controls the fan-speed to provide only the required cooling, reducing unnecessary acoustic noise. O = Optional		•			•	6670-6690	•	•		•	•	•
Active down-programming Active circuits quickly drain the energy from the output when unit is programmed to a lower voltage. This means that a unit under test can be safely removed from its test fixture without danger of arcing. F = Full-rated output current P = Less than 100% rated output current	P	6610-P 6630-F	F	F	P	P 6670-6690 ** 6900 7900	P	P				P N6750 N6760 N6783 only F N6780

Maintenance Features

Electronic calibration in the rack Calibration requires no internal adjustments.		•	•	•	•	•	•	•	•	•	•	•
Calibration security Units can be protected from accidental access to calibration routines by either a password (P) or an internal jumper (J) or switch (s).	P, S N8900	P, S	J	J	P, J	P, S 6900 7900 P, J 6670-90	P, S	P, S	P, J	* P	* P	
Self-test Extensive self-test is triggered automatically on power-up. Additional tests can be initiated by user programming or front-panel control.	•	•	•	•	•	•	•	•	•	•	•	•

* A nonvolatile status in SCPI mode only.

**With N7909A Power Dissipator accessory

Basic DC Power Supplies...

essential features
for a tight budget

Agilent basic DC power supplies are the right choice for many applications. They provide quiet, stable DC power for both manual and automatic testing, in R&D and in manufacturing environments, where speed and accuracy are low considerations. At their price level, they have a surprising level of capability.

If you do not need the performance level and features of Agilent high performance DC power supplies, then choose Agilent basic DC power supplies. This summary table will help you decide which family of DC power supplies best meets your needs.

Comparison Summary	Agilent basic DC power supplies	Agilent high performance DC power supplies
Output power	30 W-15000 W	40 W-6600 W
Number of outputs	1-3	1-8
GPIB programming and measurement speed	Moderate	Fast
Output rise/fall time	Moderate	Fast
Convenient 1/2-rack size for bench-top use	Yes	No
Active downprogrammer for enhanced test throughput	No	Yes
Stored wake-up state	No	Yes
Programmable capabilities	Moderate	Extensive
Protection for the DUT	Moderate	Extensive



U8001A, U8002A, U8031A, U8032A

Single & Triple Output 90-375 W

90 W to 375 W total output power, up to 60 V and 6 A

Single and triple output models in half rack width size

Low noise, linear regulation

Single range output provides more current at lower voltage settings

More protection, more convenience — for less

It's often difficult to find a power supply that is just right for your test requirements and your budget. Whether you're manufacturing consumer products, testing electronic components, or simply looking for reliable, affordable power, Agilent's family of basic power supplies now includes the U8001A/U8002A single output and U8031A/U8032A triple output non-programmable models delivering up to 375 W of total power. With capabilities typically found only in programmable supplies, you get excellent value along with great efficiency in your work. As a result, you can minimize setup time and measurement errors and maximize device reliability. You'll get the right power with a difference — backed by stringent safety certifications and Agilent quality standards — at an affordable price.

The Agilent U8000 Series offers single output and triple output non-programmable DC power supplies that include features typically found only in programmable supplies. The U8000 Series delivers excellent value by providing reliable DC power, efficient setup capabilities, and important security features that let you address a variety of applications in electronics manufacturing and educational settings.

Specifications (at 0° to 40°C unless otherwise specified)	U8001A	U8002A	U8031A	U8032A
Number of outputs	1	1	3 Two variable One fixed	3 Two variable One fixed
Output ratings	0 to 30 V 0 to 3 A	0 to 30 V 0 to 5 A	0 to 30 V 0 to 6 A	0 to 60 V 0 to 3 A
5 V fixed output¹	(U8031A and U8032A output channel 3)			
Voltage & Current output	N/A	N/A	5 V, 3 A	5 V, 3 A
Output accuracy	N/A	N/A	≤ 5% or (5 V ± 0.25 V)	≤ 5% or (5 V ± 0.25 V)
V rms	N/A	N/A	< 2 mV	< 2 mV
V peak-peak	N/A	N/A	< 50 mV	< 50 mV
Load and line regulation	N/A	N/A	≤ 5 mV	≤ 5 mV
Load and line regulation (all models - output channels 1 & 2)				
Voltage	<0.01% + 2 mV	<0.01% + 2 mV	<0.01% + 2 mV	<0.01% + 2 mV
Current	<0.02% + 2 mA	<0.02% + 2 mA	<0.02% + 2 mA	<0.02% + 2 mA
Ripple and noise				
CV peak-peak	12 mV	12 mV	≤10 mV	≤10 mV
CV rms	<1 mV	<1 mV	≤1 mV	≤1 mV
CC rms	3 mA	3 mA	≤1 mA	≤1 mA
Load transient response time (from full load to half load and from half load to full load)				
Recovery time to within 15 mV	<50 μs	<50 μs	<50 ms	<50 ms
Programming accuracy² (25°C ±5°C)				
Voltage	<0.35% + 20 mV	<0.35% + 20 mV	<0.25% + 15 mV	<0.25% + 15 mV
Current	<0.35% + 20 mA	<0.35% + 20 mA	<0.30% + 15 mA	<0.30% + 15 mA
Readback accuracy² (25°C ±5°C)				
Voltage	<0.35% + 20 mV	<0.35% + 20 mV	<0.25% + 10 mV	<0.25% + 10 mV
Current	<0.35% + 20 mA	<0.35% + 20 mA	<0.25% + 10 mA	<0.25% + 10 mA
Meter resolution				
Voltage	10 mV	10 mV	10 mV	10 mV
Current	10 mA	10 mA	10 mA	10 mA
Maximum output float voltage	±240 VDC	±240 VDC	±240 VDC	±240 VDC

¹ The specifications referenced in this section are for Output Channel 3 (5 V fixed output). All other specifications listed for the U8031A and U8032A in this table are intended for Output Channel 1 and 2.

² Specifications are based on one hour warm-up period

Single & Triple Output: 90-375 W (Continued)

Specifications (at 0° to 40°C unless otherwise specified)	U8001A	U8002A	U8031A	U8032A
--	--------	--------	--------	--------

Power that's suitable for your application requirements

The U8000 Series with total power ranging from 90 W to 375 W provides performance that is suitable for electronics manufacturing for computers and peripherals, communication systems and peripherals, aircraft/avionics systems, electronic components, and more. The U8000 Series complements the Agilent E3600 DC power supplies family to provide a wider range of power source alternatives.

Differentiated features typically found only in programmable power supplies

The U8000 Series offers fully integrated over voltage protection (OVP) and over current protection (OCP) to prevent damage to the device-under-test (DUT). Using the capability to save and recall three memory states, you can minimize errors and reduce set-up time. The U8000 Series also provides security features such as keypad lock to prevent measurement errors due to accidental front panel usage. When the keypad lock is activated, the knob and all the buttons on the front panel are disabled except the keypad lock button. The physical lock mechanism found at the rear panel of the power supply provides secure instrument storage. The LCD display with backlight on/off options enables brighter display for data viewing.

Supplemental Characteristics

(Non-warranted characteristics determined by design that are useful in applying the product)

Voltage programming speed				
Up full load	150 ms	150 ms	80 ms	200 ms
No load	100 ms	100 ms	80 ms	100 ms
Down full load	30 ms	30 ms	30 ms	30 ms
No load	450 ms	450 ms	150 ms	300 ms
Last memory setting enabled	Yes	Yes	Yes	Yes

¹ The specifications referenced in this section are for Output Channel 3 (5 V fixed output). All other specifications listed for the U8031A and U8032A in this table are intended for Output Channel 1 and 2.

² Specifications are based on one hour warm-up period

Solid, reliable performance in its class

The U8000 Series provides excellent load and line regulation (Constant Voltage, CV: < 0.01% +2 mV; Constant Current, CC: < 0.02% +2 mA) to ensure stable output even when the load changes. With the fast 50 µsec transient response, test times and manufacturing cost are significantly reduced. The U8000 Series comes with low output noise of 1 mVrms, 3 mArms from 20 Hz to 20 MHz, providing clean output and minimizing the interference in the DUT.

Ordering information

- Opt 0E9:** 90 to 110 Vac, 47 to 63 Hz
- Opt 0EM:** 104 to 126 Vac, 47 to 63 Hz
- Opt 0E3:** 207 to 253 Vac, 47 to 63 Hz
- Opt UK6:** Commercial calibration with test result data

Accessories

- 34190A** Rack mount kit including filler panel

Supplemental characteristics for all model numbers

Size: U8001A, U8002A: 212.3 mm W x 88.1 mm H x 394.3 mm D (8.4 in x 3.5 in x 15.5 in);
 U8031A-U8032A: 212.3 mm W x 179.0 mm H x 379.0 mm D (8.4 in x 7.0 in x 14.9 in);

Weight:
 U8001A: 7.3 kg (16.1 lbs)
 U8002A: 8.3 kg (18.3 lbs)
 U8031A, U8032A: 8.2 kg (18.1 lbs)

Warranty: Three years



E3620A, E3630A

Multiple-Output 35 W and 50 W

- Dual and triple outputs
- Small, compact size for bench use
- Low-noise and excellent regulation
- Overload indicator to monitor output
- Autotracking for outputs synchronization

Specifications

(at 0° to 55°C unless otherwise specified)

	E3620A	E3630A
Number of outputs	2	3
 GPIB	No	No
Output ratings*		
Output 1	0 to 25 V, 0 to 1 A	0 to 6 V, 0 to 2.5 A*
Output 2	0 to 25 V, 0 to 1 A	0 to +20 V, 0 to 0.5 A
Output 3	—	0 to -20 V, 0 to 0.5 A
Power (max)	50 W	35 W
Load regulation	0.01% + 2 mV	0.01% + 2 mV
Ripple and noise from 20 Hz to 20 MHz		
Normal mode voltage rms	350 µV	350 µV
peak-to-peak	1.5 mV	1.5 mV
Common mode current	1 µArms	1 µArms
Control mode	CV/CL	CV/CL (±20 V), CV/CF (6 V)
Meter resolution (Minimum change using front-panel controls)		
Voltage	10 mV (0-20 V), 100 mV, (>20 V)	10 mV
Current	1 mA	10 mA
Input power	115 Vac ± 10%, 47 to 63 Hz	115 Vac, ± 10%, 47 to 63 Hz

*Maximum current is derated 3.3% per °C from 40°C to 55°C

☎ For off-the-shelf shipment

These linear-regulated DC power supplies provide reliable and convenient DC power on a lab bench. Voltage and current can be monitored simultaneously on the front panel meters. There is also an overload indicator for each output.

E3620A

The E3620A has two isolated, independent, CV/CL 25 volt outputs. It is easy to make precise adjustments using the 10-turn pots.

E3630A

The E3630A triple output power supply has two 20 volt outputs and one 6 volt output. The +6 V output is an isolated constant-voltage/current-foldback output, and both the +20 volt output and the -20 volt output are constant-voltage/current-limit. An autotracking feature lets you use one voltage control to adjust both 20 volt outputs. These outputs track each other to within one percent, making it easy to adjust the power supply for circuits requiring balance voltages. The ±20 volt outputs are referenced together to a floating common.

Application notes

Understanding Linear Power Supply Operation (AN1554)
5989-2291EN

10 Practical Tips You Need to Know About Your Power Products
5965-8239E

Supplemental characteristics

Size: E3620A:
213 mm W x 91 mm H x 401 mm D
(8.4 in x 3.6 in x 15.8 in)
E3630A:
213 mm W x 92 mm H x 320 mm D
(8.4 in x 3.6 in x 12.6 in)

Weight: E3620A: 5.5 kg (12.1 lbs)
E3630A: 3.8 kg (8.4 lbs)

Warranty: Three years

Ordering information

Opt 0E9 90 to 110 VAC, 47 to 63 Hz
(Japan only)
Opt 0EM 104 to 126 VAC, 47 to 63 Hz
Opt 0E3 207 to 253 VAC, 47 to 63 Hz

Accessories

34190A Rack mount kit including filler panel

More detailed specifications at www.agilent.com/find/E3600



E3631A

Triple-Output 80 W GPIB

- Small, compact size for bench use
- Low output ripple and noise
- Built-in measurements and basic programmable features
- Over-voltage protection to ensure DUT safety
- Three memory states to ease test setup

Specifications

(at 0° to 55°C unless otherwise specified)

E3631A

This is the DC power supply for every engineer's or electronic technician's lab bench. It has two tracking 25 V outputs, which are together referenced to a floating common, and an isolated 6 volt output. It is easy to control from the front panel, or with industry standard SCPI commands via the GPIB or RS232. *VXIPlug&Play* drivers are available to further simplify computer control. Up to 3 complete states can be stored for later recall. The low noise, excellent regulation, and built-in voltmeter/ammeter make this reliable power supply well suited for the needs of the R&D lab.

Application notes

Understanding Linear Power Supply Operation (AN1554)
5989-2291EN

10 Practical Tips You Need to Know About Your Power Products
5965-8239E

Supplemental characteristics for all model numbers

Product regulation: Designed to comply with UL1244, IEC 1010-1; certified with CSA 22.2
Meets requirements for CE regulation

Software driver:

- IVI-COM
- *VXIPlug&Play*
- IntuiLink Connectivity Software

DC outputs			
Voltage	0 to +25 V	0 to -25 V	0 to 6 V
Current	0 to 1 A	0 to 1 A	0 to 5 A
Load regulation			
Voltage	<0.01% + 2 mV	<0.01% + 2 mV	<0.01% + 2 mV
Current	<0.01% + 250 µA	<0.01% + 250 µA	<0.01% + 250 µA
Line regulation			
Voltage	<0.01% + 2 mV	<0.01% + 2 mV	<0.01% + 2 mV
Current	<0.01% + 250 µA	<0.01% + 250 µA	<0.01% + 250 µA
Ripple and noise from 20 Hz to 20 MHz			
Normal-mode voltage	<350 µVrms/2 mVp-p	<350 µVrms/2 mVp-p	<350 µVrms/2 mVp-p
Normal-mode current	<500 µArms	<500 µArms	<2 mArms
Common-mode current	<1.5 µArms	<1.5 µArms	<1.5 µArms
Programming accuracy at 25°C ±5°C			
Voltage	0.05% + 20 mV	0.05% + 20 mV	0.1% + 5 mV
Current	0.15% + 4 mA	0.15% + 4 mA	0.2% + 10 mA
Readback accuracy at 25°C ±5°C			
Voltage	0.05% + 10 mV	0.05% + 10 mV	0.1% + 5 mV
Current	0.15% + 4 mA	0.15% + 4 mA	0.2% + 10 mA
Resolution			
Program/readback	1.5 mV, 0.1 mA	1.5 mV, 0.1 mA	0.5 mV, 0.5 mA
Meter	10 mV, 1 mA	10 mV, 1 mA	1 mV, 1 mA
Transient response 50 µs for output to recover to within 15 mV following a change in output current from full load to half load or vice versa			

☎ For off-the-shelf shipment

Size: E3631A:
213 mm W x 133 mm H x 348 mm D
(8.4 in. x 5.2 in. x 14.2 in.)

Weight: E3631A: 8.2 kg (18 lbs)

Warranty: One year

Ordering information

Opt 0E9 90 to 110 VAC, 47 to 63 Hz
(Japan only)

Opt 0EM 104 to 126 VAC, 47 to 63 Hz

Opt 0E3 207 to 253 VAC, 47 to 63 Hz

Accessories

34193A Rack mount flange kit including filler panel 132.6 mm H (3U) - one bracket, one half-module bracket

More detailed specifications at www.agilent.com/find/E3600



E3632A-E3634A

Single-Output 120 W to 200 W GPIB

- Dual range outputs
- Small, compact size for bench use
- Low output ripple and noise
- Built-in measurements and basic programmable features
- Protection features to ensure DUT safety

Specifications

(at 0° to 55°C unless otherwise specified)

	E3632A	E3633A	E3634A
Number of outputs	1	1	1
GPIB	Yes	Yes	Yes
Output ratings			
Range 1	0 to 15 V, 7 A	0 to 8 V, 20 A	0 to 25 V, 7 A
Range 2	0 to 30 V, 4 A	0 to 20 V, 10 A	0 to 50 V, 4 A
Load regulation			
Voltage	<0.01% + 2 mV	<0.01% + 2 mV	<0.01% + 2 mV
Current	<0.01% + 250 µA	<0.01% + 250 µA	<0.01% + 250 µA
Line regulation			
Voltage	<0.01% + 2 mV	<0.01% + 2 mV	<0.01% + 2 mV
Current	<0.01% + 250 µA	<0.01% + 250 µA	<0.01% + 250 µA
Ripple and noise from 20 Hz to 20 MHz			
Normal-mode voltage	<350 µVrms/2 mVp-p	<350 µVrms/3 mVp-p	<500 µVrms/3 mVp-p
Normal-mode current	<2 mArms	<2 mArms	<2 mArms
Common-mode current	<1.5 µArms	<1.5 µArms	<1.5 µArms
Programming accuracy at 25°C ±5°C			
Voltage	0.05% + 10 mV	0.05% + 10 mV	0.05% + 10 mV
Current	0.2% + 10 mA	0.2% + 10 mA	0.2% + 10 mA
Readback accuracy at 25°C ±5°C			
Voltage	0.05% + 5 mV	0.05% + 5 mV	0.05% + 5 mV
Current	0.15% + 5 mA	0.15% + 5 mA	0.15% + 5 mA
Resolution			
Program	1 mV, 0.5 mA	1 mV, 1 mA	3 mV, 0.5 mA
Readback	0.5 mV, 0.1 mA	0.5 mV, 1 mA	1.5 mV, 0.5 mA
Meter	1 mV, 1 mA	1 mV, 1 mA (<10 A/10 mA (≥10 A))	1 mV, 1 mA (<10 A/10 mA (≥10 A))
Transient response	50 µs for output to recover to within 15 mV following a change in output current from full load to half load or vice versa		

* Maximum current is derated 1% per °C from 40°C to 55°C %

☎ For off-the-shelf shipment

These dual range DC power supplies provide the stable, accurate, and reliable DC power that the R&D engineer needs. These models are CV/CC, so they can serve as either voltage or current sources. They can be used either for manual or automated testing where moderate speed and accuracy are required. VXIPlug&Play drivers further simplify computer control.

These DC power supplies have many features to help the R&D engineer to quickly and easily bias and monitor prototype circuitry. Remote sensing eliminates the errors in voltage regulation due to voltage drops in the load leads. Delicate prototypes are protected by overvoltage and overcurrent protection features. Up to 3 frequently used operating states may be stored for later recall. The output is isolated from chassis ground.

For applications where even higher accuracy is needed, or speed must be optimized, see the Agilent 6600 series of performance DC power supplies.

Single-Output: 120 W to 200 W (Continued)

Application notes

Understanding Linear Power Supply Operation (AN1554)
5989-2291EN

10 Practical Tips You Need to Know About Your Power Products
5965-8239E

Modern Connectivity - Using USB and LAN I/O Converters (AN 1475-1)
5989-0123EN

Supplemental characteristics for all model numbers

Product regulation: Designed to comply with UL1244, IEC 61010-1; certified with CSA 22.2
Meets requirements for CE regulation

Software driver:

- IVI-COM
- *VXIPlug&Play*
- IntuiLink Connectivity Software

Size: 213 mm W x 133 mm H x 348 mm D
(8.4 in. x 5.2 in. x 13.7 in.)

Weight: 9.5 kg (21 lbs)

Warranty: Three years

Ordering information

Opt 0E9 90 to 110 VAC, 47 to 63 Hz
(Japan only)

Opt 0EM 104 to 126 VAC, 47 to 63 Hz

Opt 0E3 207 to 253 VAC, 47 to 63 Hz

Accessories

34192A Rack mount flange kit
132.6 mm H (3U) - two flange brackets
(E3632A)

34193A Rack mount flange kit
132.6 mm H (3U) - one bracket, one
half-module bracket (E3632 - E3634)



E3640A-E3649A

Single & Dual Output 30-100 W GPIB

- Dual range outputs
- Small, compact size for bench and system use
- Low output ripple and noise
- Built-in measurements and basic programmable features
- Over-voltage protection to ensure DUT safety

Specifications

(at 0° to 55°C unless otherwise specified)

	E3640A	E3641A	E3642A	E3643A	E3644A
Number of outputs	1	1	1	1	1
GPIB	Yes	Yes	Yes	Yes	Yes
DC outputs					
Voltage	0 to 8 V	0 to 35 V	0 to 8 V	0 to 35 V	0 to 8 V
Current	3 A	0.8 A	5 A	1.4 A	8 A
Voltage	0 to 20 V	0 to 60 V	0 to 20 V	0 to 60 V	0 to 20 V
Current	1.5 A	0.5 A	2.5 A	0.8 A	4 A
Power (max)	30 W	30 W	50 W	50 W	80 W
Load and line regulation					
Voltage	<0.01% + 3 mV	<0.01% + 3 mV	<0.01% + 3 mV	<0.01% + 3 mV	<0.01% + 3 mV
Current	<0.01% + 250 µA	<0.01% + 250 µA	<0.01% + 250 µA	<0.01% + 250 µA	<0.01% + 250 µA
Ripple and noise from 20 Hz to 20 MHz					
Normal-mode voltage	<500 µVrms 5 mVp-p	<1 mVrms 8 mVp-p	<500 µVrms 5 mVp-p	<1 mVrms 8 mVp-p	<500 µVrms 5 mVp-p
Normal-mode current	<4.0 mArms	<4.0 mArms	<4.0 mArms	<4.0 mArms	<4.0 mArms
Common-mode current	<1.5 µArms	<1.5 µArms	<1.5 µArms	<1.5 µArms	<1.5 µArms
Programming accuracy at 25°C ±5°C					
Voltage	<0.05% + 10 mV	10 mV	10 mV	10 mV	10 mV
Current	<0.2% + 10 mA	10 mA	10 mA	10 mA	10 mA
Readback accuracy at 25°C ±5°C					
Voltage	<0.05% + 5 mV	5 mV	5 mV	5 mV	5 mV
Current	<0.15% + 5 mA	5 mA	5 mA	5 mA	5 mA
Program resolution					
Voltage	5 mV	5 mV	5 mV	5 mV	5 mV
Current	1 mA	1 mA	1 mA	1 mA	1 mA
Readback resolution					
Voltage	2 mV	2 mV	2 mV	2 mV	2 mV
Current	1 mA	1 mA	1 mA	1 mA	1 mA
Meter resolution					
Voltage	10 mV	10 mV	10 mV	10 mV	10 mV
Current	1 mA	1 mA	1 mA	1 mA	1 mA
Transient response	<50 µs for output to recover to within 15 mV following a change in output current from full load to half load or vice versa.				

* Maximum current is derated 1% per °C from 40°C to 55°C

These isolated dual range DC power supplies provide the stable and reliable DC power that the manufacturing test system designer needs. These models offer constant-voltage/constant-current outputs, so they can serve as either voltage or current sources. They can be used either for manual or automated testing, and have VXIPlug&Play drivers to further simplify computer control.

The E3640A series DC power supplies can be quickly integrated into a test system. Both front and rear panel terminals are provided for easy wiring. Remote sensing eliminates the errors in voltage regulation due to voltage drops in the load leads. Delicate DUTs are protected by overvoltage protection. Up to 5 operating states can be stored for later recall.

The E3640A series DC power supplies are intended for manufacturing test systems where moderate speed and accuracy are required. For systems which require even higher accuracy for programming or measurement, or where test throughput must be optimized, consider the Agilent 6600A and N6700 series of performance DC power supplies.

Single & Dual Output: 30-100 W GPIB (Continued)

Specifications (at 0° to 55°C unless otherwise specified)	E3645A	E3646A	E3647A	E3648A	E3649A
Number of outputs	1	2	2	2	2
GPIB	Yes	Yes	Yes	Yes	Yes
DC outputs					
Voltage	0 to 35 V	0 to 8 V	0 to 35 V	0 to 8 V	0 to 35 V
Current	2.2 A	3 A	0.8 A	5 A	1.4 A
Voltage	0 to 60 V	0 to 20 V	0 to 60 V	0 to 20 V	0 to 60 V
Current	1.3 A	1.5 A	0.5 A	2.5 A	0.8 A
Power (max)	80 W	60 W	60 W	100 W	100 W
Load and line regulation					
Voltage	<0.01% + 3 mV	3 mV	3 mV	3 mV	3 mV
Current	<0.01% + 250 µA	250 µA	250 µA	250 µA	250 µA
Ripple and noise from 20 Hz to 20 MHz					
Normal-mode voltage	<1 mVrms 8 mVp-p	<500 µVrms 5 mVp-p	<1 mVrms 8 mVp-p	<500 µVrms 5 mVp-p	<1 mVrms 8 mVp-p
Normal-mode current	<4.0 mArms	<4.0 mArms	<4.0 mArms	<4.0 mArms	<4.0 mArms
Common-mode current	<1.5 µArms	<1.5 µArms	<1.5 µArms	<1.5 µArms	<1.5 µArms
Programming accuracy at 25°C ±5°C					
Voltage	<0.05% + (<0.1% + 25 mA for output 2)	10 mV	10 mV	10 mV	10 mV
Current	<0.2% + 10 mA	10 mA	10 mA	10 mA	10 mA
Readback accuracy at 25°C ±5°C					
Voltage	<0.05% + (<0.1% + 25 mV for output 2)	5 mV	5 mV	5 mV	5 mV
Current	<0.15% + (<0.15% + 10 mA for output 2)	5 mA	5 mA	5 mA	5 mA
Program resolution					
Voltage	5 mV	5 mV	5 mV	5 mV	5 mV
Current	1 mA	1 mA	1 mA	1 mA	1 mA
Readback resolution					
Voltage	2 mV	2 mV	2 mV	2 mV	2 mV
Current	1 mA	1 mA	1 mA	1 mA	1 mA
Meter resolution					
Voltage	10 mV	10 mV	10 mV	10 mV	10 mV
Current	1 mA	1 mA	1 mA	1 mA	1 mA
Transient response	<50 µs for output to recover to within 15 mV following a change in output current from full load to half load or vice versa.				

*Maximum current is derated 1% per °C from 40°C to 55°C

Application notes

Understanding Linear Power Supply Operation (AN1554)

5989-2291EN

10 Practical Tips You Need to Know About Your Power Products

5965-8239E

Modern Connectivity - Using USB and LAN I/O Converters (AN 1475-1)

5989-0123EN

Supplemental characteristics for all model numbers

DC floating voltage: Output terminals can be floated up to ±240 VDC from chassis ground

Remote sensing: Up to 1 V can be dropped in each load lead. The drop in the load leads subtracts from the voltage available for the load.

Settling time: Less than 90 ms for the output voltage to change from 1% to 99% or vice versa following the receipt of VOLTage or APPLy command via direct GPIB or RS-232 interface.

Product regulation:

Designed to comply with UL3111-1; certified to CSA 22.2 No. 1010.1; conforms to IEC 1010-1; complies with EMC directive 89/336/EEC(Group1, Class A)

OVP accuracy: 0.5% + 0.5 V, activation time: ≥3 V, <1.5 ms, and <3 V, <10 ms

Isolation: ±240 VDC

Stability: Voltage <0.02% + 2 mV; Current <0.1% + 1 mA

Temperature coefficient: <0.01% + 3 mV, <0.02% + 3 mA change per °C over operating range 0-40 °C after 30 minute warm-up

Software driver:

- IVI-COM
- VXIPlug&Play
- IntuiLink Connectivity Software

Warranty: Three years

Size: E3640A-E3645A:

213 mm W x 88 mm H x 348 mm D (8.4 in x 3.5 in x 13.7 in)

E3646A-E3649A:

213 mm W x 133 mm H x 348 mm D (8.4 in. x 5.2 in. x 13.7 in.)

Weight: E3640A, E3641A: 5.3 kg (11.7 lbs)

E3642A, E3643A: 6.2 kg (13.7 lbs)

E3644A, E3645A: 6.7kg (14.7 lbs)

E3646A, E3647A: 7.4 kg (16.1 lbs)

E3648A, E3649A: 9.5 kg (20.3 lbs)

Ordering Information

Opt 0E3 207 to 253 VDC, 47 to 63 Hz

Opt 0E9 90 to 110 VDC, 47 to 63 Hz (Japan only)

Opt 0EM 104 to 126 VDC, 47 to 63 Hz

Accessories

34190A Rack mount kit including filler panel (E3640A-E3645A)

34193A Rack mount flange kit 132.6 mm H (3U) - including filler panel - one bracket, one half-module bracket (E3646A - E3649A)

More detailed specifications at www.agilent.com/find/E3600

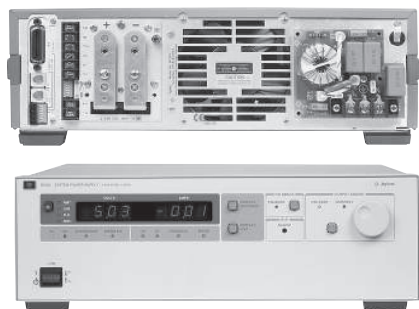

6030A, 6031A, 6032A, 6033A, 6035A, 6038A

Single-Output, Autoranging 200 W and 1000 W GPIB

- Autoranging outputs provide maximum power at a variety of operating voltages
- Analog/resistance control of output voltage and current
- Series and auto-parallel connections of multiple supplies
- Built-in measurements and advanced programmable features
- Protection features to ensure DUT safety

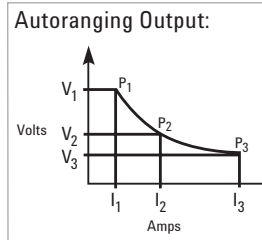

Specifications (at 0° to 55°C unless otherwise specified)

This series of 200 watt and 1000 watt DC power supplies take the place of multiple power supplies in your test system by providing maximum power at a variety of operating points.

Industry standard SCPI commands and VXIPlug&Play drivers make system integration easy. Using the serial link, up to 16 power supplies can be connected through one GPIB address. These power supplies have excellent electrical efficiency, making them a good choice for large systems.

Application notes

10 Hints for Using Your Power Supply to Decrease Test Time
5968-6359E

10 Practical Tips You Need to Know About Your Power Products
5965-8239E

Agilent DC Power Supplies for Base Station Testing
5988-2386EN

Specifications		6030A	6031A	6032A	6033A	6035A	6038A
Number of outputs		1	1	1	1	1	1
GPIB		Yes	Yes	Yes	Yes	Yes	Yes
Output ratings							
Output voltage		0 to 200 V	0 to 20 V	0 to 60 V	0 to 20 V	0 to 500 V	0 to 60 V
Output current		0 to 17 A	0 to 120 A	0 to 50 A	0 to 30 A	0 to 5 A	0 to 10 A
Maximum power watts		1,200 W	1,064 W	1,200 W	240 W	1,050 W	240 W
Auto-ranging output	V_1, I_1	200 V, 5 A	20 V, 50 A	60 V, 17.5 A	20 V, 10 A	500 V, 2 A	60 V, 3.3 A
	V_2, I_2	120 V, 10 A	14 V, 76 A	40 V, 30 A	14 V, 17.2 A	350 V, 3 A	40 V, 6 A
	V_3, I_3	60 V, 17 A	7 V, 120 A	20 V, 50 A	6.7 V, 30 A	200 V, 5 A	20 V, 10 A
Programming accuracy at 25°C ±5°C	Voltage	0.035% +145 mV	0.035% +15 mV	0.035% +40 mV	0.035% +9 mV	0.25% +400 mV	0.035% +40 mV
	Current	0.2% +25 mA	0.25% +250 mA	0.2% +85 mA	0.15% +20 mA	0.3% +63 mA	0.09% +10 mA
Ripple and noise 20 Hz to 20 MHz	Voltage rms p-p	22 mV 50 mV	8 mV 50 mV	8 mV 40 mV	3 mV 30 mV	50 mV 160 mV	3 mV 30 mV
	Current rms	15 mA	120 mA	25 mA	30 mA	50 mA	5 mA
Readback accuracy at 25°C ±5°C	Voltage	0.08% +80 mV	0.08% +7 mV	0.08% +20 mV	0.07% +6 mV	0.5% +200 mV	0.07% +50 mV
	Current	0.36% +15 mA	0.4% +100 mA	0.36% +35 mA	0.3% +25 mA	0.5% +50 mA	0.2% +11 mA
Load regulation							
Voltage	0.01%+	5 mV	3 mV	5 mV	2 mV	40 mV	3 mV
Current	0.01%+ 10 mA	0.01%+ 15 mA	0.01%+ 10 mA	0.01%+ 9 mA	0.03%+ 34 mA	0.01%+ 5 mA	
Line regulation							
Voltage	0.01%+ 5 mV	0.01%+ 2 mV	0.01%+ 3 mV	0.01%+ 1 mV	0.01%+ 13 mV	0.01%+ 2 mV	
Current	0.01%+ 5 mA	0.01%+ 25 mA	0.01%+ 10 mA	0.01%+ 6 mA	0.03%+ 17 mA	0.01%+ 2 mA	
Transient response time 10% step change	Time	2 ms	2 ms	2 ms	1 ms	5 ms	1 ms
	Level	150 mV	100 mV	100 mV	50 mV	200 mV 7	5 mV

Autoranging: 200 W and 1000 W GPIB (Continued)

Specifications (at 0° to 55°C unless otherwise specified)	6030A	6031A	6032A	6033A	6035A	6038A
--	-------	-------	-------	-------	-------	-------

Supplemental characteristics for all model numbers

Remote sensing: Up to 2 V drop in each lead. Voltage regulation specification met with up to 0.5 V drop, but degrades for greater drops.

Modulation: (analog programming of output voltage and current)
Input signal: 0 to 5 V or 0 to 4 kΩ

Software driver:
VXIPlug&Play

Size: 6030A–32A, 6035A:
425.5 mm W x 132.6 mm H x 503.7 mm D
(16.75 in x 5.25 in x 19.83 in).
6033A, 6038A:
212.3 mm W x 177.0 mm H x 516.4 mm D
(8.36 in x 6.97 in x 17.87 in).

Warranty: Three years

Supplemental Characteristics

(Non-warranted characteristics determined by design and useful in applying the product)

Programming resolution	Voltage	50 mV	5 mV	15 mV	5 mV	125 mV	15 mV
	Current	4.25 mA	30 mA	12.5 mA	7.5 mA	1.25 mA	2.5 mA
DC floating voltage either terminal can be grounded or floated from chassis ground		±550 V	±240 V	±240 V	±240 V	±550 V	±240 V
AC input current	100 VAC	24 A	24 A	24 A	6 A	24 A	6 A
	120 VAC	24 A	24 A	24 A	6.5 A	24 A	6.5 A
	220 VAC	15 A	15 A	15 A	3.8 A	15 A	3.8 A
	240 VAC	14 A	14 A <td 14 A	3.6 A	14 A	3.6 A	
Weight	Net	16.3 kg (36 lb)	17.2 kg (38 lb)	16.3 kg (36 lb)	9.6 kg (21 lb)	16.3 kg (36 lb)	9.6 kg (21 lb)
	Shipping	21.8 kg (48 lb)	22.7 kg (50 lb)	21.8 kg (48 lb)	11.4 kg (25 lb)	21.8 kg (48 lb)	11.4 kg (25 lb)

Agilent Models: 6030A, 6031A, 6032A, 6035A

Terminal Strip Detail

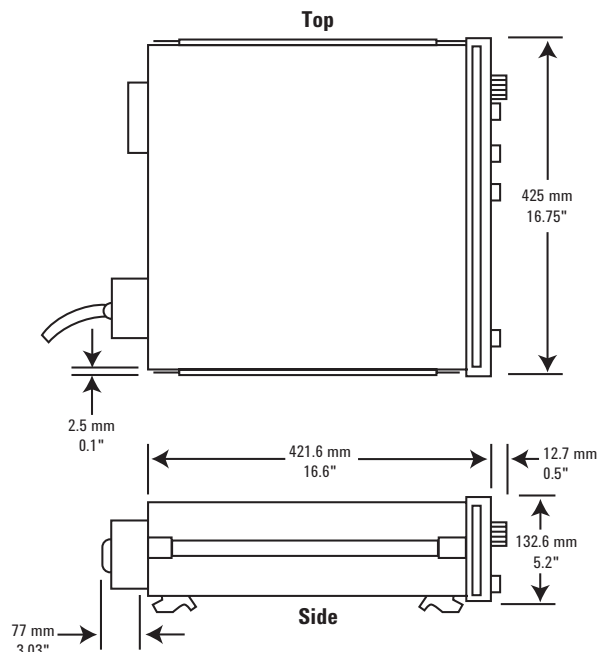
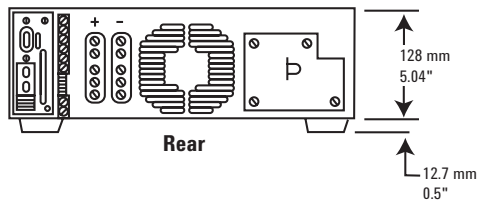
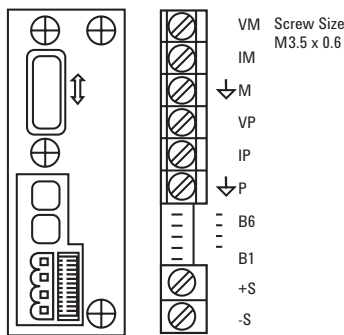

More detailed specifications at www.agilent.com/find/6030

Autoranging: 200 W and 1000 W GPIB (Continued)

Ordering information

- Opt 001** Front panel has only line switch, line indicator, and OVP adjust (6030A–33A and 6038A only)
- Opt 100** 87 to 106 VAC, 48 to 63 Hz (power supply output is derated to 75%)
- Opt 120** 104 to 127 VAC, 47 to 63 Hz
- Opt 220** 191 to 233 VAC, 48 to 63 Hz
- Opt 240** 209 to 250 VAC, 48 to 63 Hz
- Opt 0L1** English printed operating manual (full documentation on CD-ROM)
- Opt 0B3** English printed service manual
- Opt J01** Stabilization for loads up to 10 Henries (not available on 6033A)

A line cord option must be specified, see the AC line voltage and cord section.

Accessories

- 5080-2148** Serial link cable, 2 m (6.6 ft)
 - 1494-0060** Rack slide kit
 - E3663AC** Support rails for Agilent rack cabinets
- For models: 6033A and 6038A
- * **1CM001A** Rack mount flange kit 177.0 mm H (4U) - one bracket, one half-module bracket
 - * **1CM034A** Rack mount flange kit 177.0 mm H (4U) - two flange brackets and lock link kit for mounting two 6033A or 6038A units side by side.

For models: 6030A, 6031A, 6032A, 6035A

- * **1CM003A** Rack mount flange kit 132.6 mm H (3U) - two flange brackets
 - * **1CP002A** Rack mount flange and handle kit 132.6 mm H (3U) - two brackets and front handles
- * Support rails required

Agilent Models: 6033A, 6038A

Terminal Strip Detail

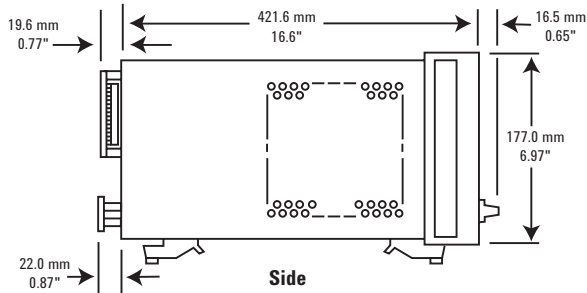
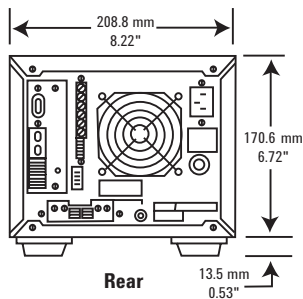
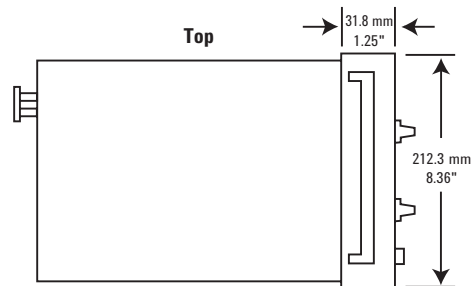
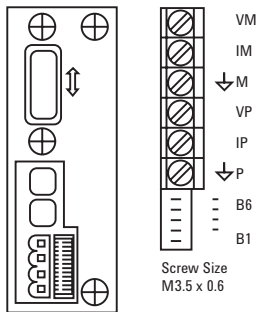

More detailed specifications at www.agilent.com/find/6030

Single-Output

750-1500 W GPIB, LAN, USB, LXI Core

N5741A*



N5741A - N5772A

- Small size: 1U high
- Universal AC input (85-265 VAC)
- Analog/resistance control of output voltage and current
- Parallel and series connection of multiple supplies
- Built-in measurements and advanced programmable features
- Protection features to ensure DUT safety
- LXI Core compliant

Specifications

(at 0° to 55°C unless otherwise specified)

	N5741A	N5742A	N5743A	N5744A	N5745A	N5746A
Number of outputs	1	1	1	1	1	1
GPIB, LAN, USB	Yes	Yes	Yes	Yes	Yes	Yes
Output Ratings						
Voltage	6 V	8 V	12.5 V	20 V	30 V	40 V
Current	100 A	90 A	60 A	38 A	25 A	19 A
Power	600 W	720 W	750 W	760 W	750 W	760 W
Programming accuracy						
Voltage	0.05%+	3 mV	4 mV	6.25 mV	10 mV	15 mV
Current	0.1%+	100 mA	90 mA	60 mA	38 mA	19 mA
Output ripple and noise						
CV p-p (Up to 20 MHz)	60 mV	60 mV	60 mV	60 mV	60 mV	60 mV
CV rms (From 5 Hz – 1 MHz)	8 mV	8 mV	8 mV	8 mV	8 mV	8 mV
Readback accuracy						
Voltage	0.1%+	6 mV	8 mV	12.5 mV	20 mV	30 mV
Current	0.1%+	300 mA	270 mA	180 mA	114 mA	75 mA
Load regulation (change from 10% to 90%)						
Voltage	2.6 mV	2.8 mV	3.25 mV	4 mV	5 mV	6 mV
Current	25 mA	23 mA	17 mA	12.6 mA	10 mA	8.8 mA
Line regulation (change from 85-132 VAC input or 170-265 VAC input)						
Voltage	2.6 mV	2.8 mV	3.25 mV	4 mV	5 mV	6 mV
Current	12 mA	11 mA	8 mA	5.8 mA	4.5 mA	3.9 mA
Transient response time¹						
Time	≤1.5 ms	≤1.5 ms	≤1.5 ms	≤1 ms	≤1 ms	≤1 ms

Notes:

¹ Time for output voltage to recover within 0.5% of its rated output for a load change from 10 to 90% of its rated output current. Voltage set point from 10% to 100% of rated output

* AC input connector: IEC 320 connector for 750 W models, and wire clamp connector for 1500 W models

The N5700 Series is a family of affordable 750 W and 1500 W switching regulated, single-output programmable DC power supplies. They offer 24 models for simple DC power application where speed and accuracy are not the primary concern. They provide stable output power, built-in voltage and current measurement, and output voltage and current from 6 V to 600 V and 1.3 A to 180 A.

Small, high-density package

The N5700 provides up to 1500 W in a small space-saving 1U high, 19-inch wide package. Its air vents are in the front, side and rear (not on the top or bottom), so you can stack other instruments directly above or below it to save valuable rack space.

Universal AC input

All models have universal AC input so they can be automatically operated from any AC mains input worldwide. They can be operated from line voltages of 85 – 265 VAC, 47 to 63 Hz, with no switch to set or fuses to change when you switch from one voltage standard to another. They also provide power factor correction.

Single-Output 750 W & 1500 W GPIB, LAN, USB (Continued)

Specifications

(at 0° to 55°C unless otherwise specified)

N5741A	N5742A	N5743A	N5744A	N5745A	N5746A
--------	--------	--------	--------	--------	--------

Supplemental Characteristics

(Non-warranted characteristics determined by design that are useful in applying the product)

Output response time (settle to within ±1.0% of the rated output, with a resistive load)						
Up, full load	0.08 s	0.08 s	0.08 s	0.08 s	0.08 s	0.08 s
Down, full load	0.05 s	0.05 s	0.05 s	0.05 s	0.08 s	0.08 s
Down, no load	0.5 s	0.6 s	0.7 s	0.8 s	0.9 s	1.0 s
Remote sense compensation						
Volts/load lead	1 V	1 V	1 V	1 V	1.5 V	2 V
Output ripple and noise²						
CC rms	200 mA	180 mA	120 mA	76 mA	63 mA	48 m
Programming resolution/ measurement resolution						
Voltage	0.72 mV	0.96 mV	1.5 mV	2.4 mV	3.6 mV	4.8 mV
Current	12 mA	10.8 mA	7.2 mA	4.56 mA	3 mA	2.3 mA

Notes:

² From 5 Hz – 1 MHz, at 10% to 100% of output voltage at full load (for 6 V units from 33% to 100% of output voltage)

Extensive device protection

To safeguard your device from damage, the N5700 series power supplies provide over-temperature, over-current and over-voltage protect (OVP) to shut down the power supply output when a fault occurs. They also offer an undervoltage limit (UVL) that prevents adjustment of the output voltage below a certain limit. The combination of UVL and OVP capabilities lets you create a protection window for sensitive load circuitry.

Simplify system connection

The N5700 offers many system oriented features to simplify and accelerate test system development. They support the industry standard SCPI commands and come standard with software drivers.

With built-in GPIB, Ethernet/LAN, and USB 2.0 interfaces, the N5700 gives you the flexibility to use your I/O interface of choice today and in the future.

Additionally, the built-in Web server lets you operate, configure, and monitor the N5700 remotely via a standard browser such as Microsoft Internet Explorer.

Command compatibility

The N5700 includes a compatibility command set for the Xantrex XFR series power supplies, the Sorensen DLM series power supplies, and the Agilent 603x series power supplies. This simplifies system integration when converting to the N5700.

Agilent Models: N5741A - N5772A

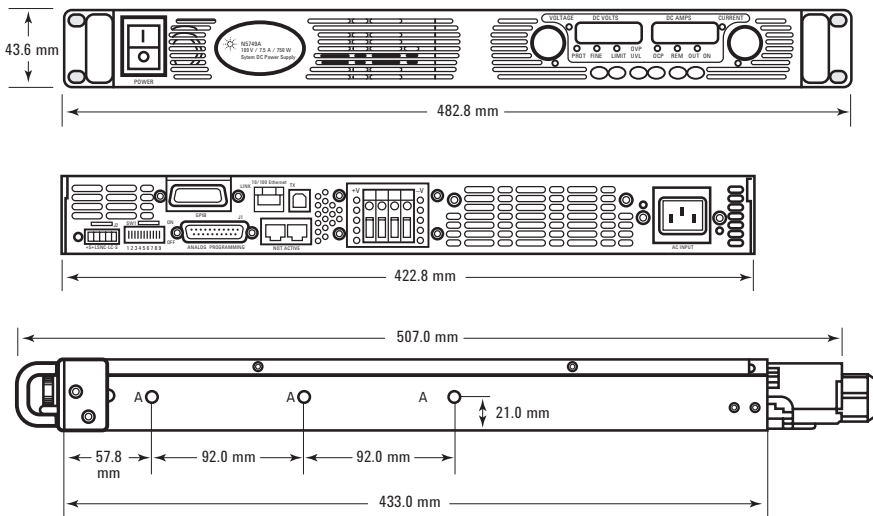

More detailed specifications at www.agilent.com/find/N5700

Single-Output 750 W & 1500 W GPIB, LAN, USB (Continued)

Analog/resistance programming

For greater programming flexibility and to minimize the time associated with computer interaction, both the output voltage and current can be controlled by an external voltage or resistance programming signal.

Connect multiple units in parallel and series

Should you need greater output power, the N5700 series power supplies give you the flexibility to connect in parallel up to four similarly rated units for greater output current and connect two similarly rated units in series for greater output voltage (see DC float voltage information)

Fan speed control

Lab bench use is enhanced by the fan speed control, which helps to minimize the acoustic noise.

Application notes

Side-by-Side Comparison:
Agilent N5700 System DC Source and Sorensen DLM Power Supply
5989-1628EN

Side-by-Side Comparison:
Agilent N5700 System DC Source and Xantrex XFR DC Power Supply
5989-1630EN

Trends in Programmable Medium Power (~1 kW) System DC Power Supplies
5989-1331EN

Notes:

¹ Time for output voltage to recover within 0.5% of its rated output for a load change from 10 to 90% of its rated output current. Voltage set point from 10% to 100% of rated output

² From 5 Hz – 1 MHz, at 10% to 100% of output voltage at full load (for 6 V units from 33% to 100% of output voltage)

Specifications

(at 0° to 55°C unless otherwise specified)

	N5747A	N5748A	N5749A	N5750A	N5751A	N5752A
Number of outputs	1	1	1	1	1	1
GPIB, LAN, USB	Yes	Yes	Yes	Yes	Yes	Yes
Output ratings						
Voltage	60 V	80 V	100 V	150 V	300 V	600 V
Current	12.5 A	9.5 A	7.5 A	5 A	2.5 A	1.3 A
Power	750 W	760 W	750 W	750 W	750 W	780 W
Programming accuracy						
Voltage	0.05%+	30 mV	40 mV	50 mV	75 mV	150 mV
Current	0.1%+	12.5 mA	9.5 mA	7.5 mA	5 mA	2.5 mA
Output ripple and noise						
CV p-p (Up to 20 MHz)	60 mV	80 mV	80 mV	100 mV	150 mV	300 mV
CV rms (From 5 Hz – 1 MHz)	8 mV	8 mV	8 mV	12 mV	20 mV	60 mV
Readback accuracy						
Voltage	0.1%+	60 mV	80 mV	100 mV	150 mV	300 mV
Current	0.1%+	37.5 mA	28.5 mA	22.5 mA	15 mA	7.5 mA
Load regulation (change from 10% to 90%)						
Voltage	8 mV	10 mV	12 mV	17 mV	32 mV	62 mV
Current	7.5 mA	6.9 mA	6.5 mA	6 mA	5.5 mA	5.26 mA
Line regulation (change from 85-132 VAC input or 170-265 VAC input)						
Voltage	8 mV	10 mV	12 mV	17 mV	32 mV	62 mV
Current	3.25 mA	2.95 mA	2.75 mA	2.5 mA	2.25 mA	2.13 mA
Transient response time¹						
Time	≤ 1 ms	≤ 1 ms	≤ 1 ms	≤ 2 ms	≤ 2 ms	≤ 2 ms

Supplemental Characteristics

Non-warranted characteristics determined by design that are useful in applying the product)

Output response time (settle to within ±1.0% of the rated output, with a resistive load)						
Up, full load	0.08 s	0.15 s	0.15 s	0.15 s	0.15 s	0.25 s
Down, full load	0.08 s	0.15 s	0.15 s	0.15 s	0.15 s	0.30 s
Down, no load	1.1 s	1.2 s	1.5 s	2.0 s	3.0 s	4.0 s
Remote sense compensation						
Volts/load lead	3 V	4 V	5 V	5 V	5 V	5 V
Output ripple and noise²						
CC rms	38 mA	29 mA	23 mA	18 mA	13 mA	8 mA
Programming resolution/ measurement resolution						
Voltage	7.2 mV	9.6 mV	12 mV	18 mV	36 mV	72 mV
Current	1.5 mA	1.14 mA	0.9 mA	0.6 mA	0.3 mA	0.156 mA

More detailed specifications at www.agilent.com/find/N5700

Single-Output 750 W & 1500 W GPIB, LAN, USB (Continued)

Supplemental characteristics for all model numbers

Command processing time: Average time required for the output voltage to begin to change following receipt of digital data is 55 ms.

DC floating voltage:

6 V to 60 V units

No output terminal may be more than ±60 VDC from any other terminal or chassis ground

80 V to 600 V units

No output terminal may be more than ±600 VDC from any other terminal or chassis ground

Modulation: (Analog programming of output voltage and current)

Input signal: selectable, 0 to 5 V/0 to 10 V full scale

Input impedance: selectable, 0 to 5 kΩ/0 to 10 kΩ full scale

I/O interface: GPIB, LAN, USB standard

Software driver:

- IVI-COM
- LabVIEW

AC input:

Input range: 85 – 265 VAC; 47 – 63 Hz

Input current 750 W: 10.5 A at 100 VAC nominal; 5 A at 200 VAC nominal

Input current 1500 W: 21 A at 100 VAC nominal; 11 A at 200 VAC nominal

Notes:

¹ Time for output voltage to recover within 0.5% of its rated output for a load change from 10 to 90% of its rated output current. Voltage set point from 10% to 100% of rated output

² From 5 Hz – 1 MHz, at 10% to 100% of output voltage at full load (for 6 V units from 33% to 100% of output voltage)

Specifications <small>(at 0° to 55°C unless otherwise specified)</small>	N5761A	N5762A	N5763A	N5764A	N5765A	N5766A
Number of outputs	1	1	1	1	1	1
GPIB, LAN, USB	Yes	Yes	Yes	Yes	Yes	Yes
Output ratings						
Voltage	6 V	8 V	12.5 V	20 V	30 V	40 V
Current	180 A	165 A	120 A	76 A	50 A	38 A
Power	1080 W	1320 W	1500 W	1520 W	1500 W	1520 W
Programming accuracy						
Voltage	0.05%+	3 mV	4 mV	6.25 mV	10 mV	15 mV
Current	0.1%+	180 mA	165 mA	120 mA	76 mA	50 mA
Output ripple and noise						
CV p-p (Up to 20 MHz)	60 mV	60 mV	60 mV	60 mV	60 mV	60 mV
CV rms (From 5 Hz – 1 MHz)	8 mV	8 mV	8 mV	8 mV	8 mV	8 mV
Readback accuracy						
Voltage	0.1%+	6 mV	8 mV	12.5 mV	20 mV	30 mV
Current	0.1%+	540 mA	495 mA	360 mA	228 mA	150 mA
Load regulation (change from 10% to 90%)						
Voltage	2.6 mV	2.8 mV	3.25 mV	4 mV	5 mV	6 mV
Current	41 mA	38 mA	29 mA	20.2 mA	15 mA	12.6 mA
Line regulation (change from 85-132 VAC input or 170-265 VAC input)						
Voltage	2.6 mV	2.8 mV	3.25 mV	4 mV	5 mV	6 mV
Current	20 mA	18.5 mA	14 mA	9.6 mA	7 mA	5.8 mA
Transient response time¹						
Time	≤ 1.5 ms	≤ 1.5 ms	≤ 1.5 ms	≤ 1 ms	≤ 1 ms	≤ 1 ms
Supplemental Characteristics (Non-warranted characteristics determined by design that are useful in applying the product)						
Output response time (settle to within ±1.0% of the rated output, with a resistive load)						
Up, full load	0.08 s	0.08 s	0.08 s	0.08 s	0.08 s	0.08 s
Down, full load	0.05 s	0.05 s	0.05 s	0.05 s	0.08 s	0.08 s
Down, no load	0.5 s	0.6 s	0.7 s	0.8 s	0.9 s	1.0 s
Remote sense compensation						
Volts/load lead	1 V	1 V	1 V	1 V	1.5 V	2 V
Output ripple and noise²						
CC rms	360 mA	330 mA	240 mA	152 mA	125 mA	95 mA
Programming resolution/ measurement resolution						
Voltage	0.72 mV	0.96 mV	1.5 mV	2.4 mV	3.6 mV	4.8 mV
Current	21.6 mA	19.8 mA	14.4 mA	9.12 mA	6 mA	4.6 mA

Single-Output 750 W & 1500 W GPIB, LAN, USB (Continued)

Power factor: 0.99 at nominal input and rated output power

Regulatory compliance: European EMC directive 89/336/EEC for Class A products, Australian C-Tick mark, this ISM device complies with Canadian ICES-001. Cet appareil ISM est conforme à la norme NMB-001 du Canada. European Low Voltage Directive 73/23/EEC.

Size: 43.6 mm H x 422.8 mm W x 432.8 mm D (1.72 in x 16.65 in x 17.04 in), excluding connectors and handles

Weight: Net, 750 W – 7 Kg (15.4 lbs); 1500 W – 8.5 Kg (18.7 lbs)

Warranty: One year

Ordering information

For N574x and N575x (750 W Models)

Opt 900 Power Cord, United Kingdom

Opt 902 Power Cord, Europe

Opt 903 Power Cord, USA, Canada

Opt 918 Power Cord, Japan

Opt 922 Power Cord, China

For N576x and N577x (1500 W Models)

Opt 861 Underterminated power cord, USA, Canada, China, Japan, Other

Opt 862 Harmonized unterminated power cord, Europe

Accessories for all N5700 Models

N5740A Rack mount slide kit (required for rack mounting; standard system II rack mounting hardware will not work).

Notes:

¹ Time for output voltage to recover within 0.5% of its rated output for a load change from 10 to 90% of its rated output current. Voltage set point from 10% to 100% of rated output

² From 5 Hz – 1 MHz, at 10% to 100% of output voltage at full load (for 6 V units from 33% to 100% of output voltage)

Specifications (at 0° to 55°C unless otherwise specified)	N5767A	N5768A	N5769A	N5770A	N5771A	N5772A
Number of outputs	1	1	1	1	1	1
GPIB, LAN, USB	Yes	Yes	Yes	Yes	Yes	Yes
Output ratings						
Voltage	60 V	80 V	100 V	150 V	300 V	600 V
Current	25 A	19 A	15 A	10 A	5 A	2.6 A
Power	1500 W	1520 W	1500 W	1500 W	1500 W	1560 W
Programming accuracy						
Voltage	0.05%+	30 mV	40 mV	50 mV	75 mV	150 mV
Current	0.1%+	25 mA	19 mA	15 mA	10 mA	5 mA
Output ripple and noise						
CV p-p (Up to 20 MHz)	60 mV	80 mV	80 mV	100 mV	150 mV	300 mV
CV rms (From 5 Hz – 1 MHz)	8 mV	8 mV	8 mV	12 mV	20 mV	60 mV
Readback accuracy						
Voltage	0.1%+	60 mV	80 mV	100 mV	150 mV	300 mV
Current	0.1%+	75 mA	57 mA	45 mA	30 mA	15 mA
Load regulation (change from 10% to 90%)						
Voltage	8 mV	10 mV	12 mV	17 mV	32 mV	62 mV
Current	10 mA	8.8 mA	8 mA	7 mA	6 mA	5.5 mA
Line regulation (change from 85-132 VAC input or 170-265 VAC input)						
Voltage	8 mV	10 mV	12 mV	17 mV	32 mV	62 mV
Current	4.5 mA	3.9 mA	3.5 mA	3 mA	2.5 mA	2.26 mA
Transient response time¹						
Time	≤ 1 ms	≤ 1 ms	≤ 1 ms	≤ 2 ms	≤ 2 ms	≤ 2 ms
Supplemental Characteristics	(Non-warranted characteristics determined by design and useful in applying the product)					
Output response time (settle to within ±1.0% of the rated output, with a resistive load)						
Up, full load	0.08 s	0.15 s	0.15 s	0.15 s	0.15 s	0.25 s
Down, full load	0.08 s	0.15 s	0.15 s	0.15 s	0.15 s	0.30 s
Down, no load	1.1 s	1.2 s	1.5 s	2.0 s	3.0 s	4.0 s
Remote sense compensation						
Volts/load lead	3 V	4 V	5 V	5 V	5 V	5 V
Output ripple and noise²						
CC rms	75 mA	57 mA	45 mA	35 mA	25 mA	12 mA
Programming resolution/ measurement resolution						
Voltage	7.2 mV	9.6 mV	12 mV	18 mV	36 mV	72 mV
Current	3 mA	2.28 mA	1.8 mA	1.2 mA	0.6 mA	0.312 mA

Single-Output

3.3-5.2 KW GPIB, LAN, USB, LXI Core



N8740*



N8731A - N8762A

- 21 Models: 3300 W and 5200 W output power
- Up to 600 V and up to 400 A
- Small, high density 2U package
- Built-in voltage and current measurement
- Full protection from over-voltage and over-current
- Flexible AC input voltage options
- LAN, USB, and GPIB interfaces standard
- Fully compliant to LXI Core

Specifications (at 0° to 55°C unless otherwise specified)	N8731A	N8732A	N8733A	N8734A	N8735A	N8736A
--	--------	--------	--------	--------	--------	--------

The Agilent Technologies N8700 series system DC power supplies give you just the right performance – at just the right price – in a compact (2 U) package. This family of affordable 3300 W and 5000 W single-output programmable DC power supplies consists of 21 models for simple DC power applications.

They provide stable output power, built-in voltage and current measurement, and output voltage and current from 8 V to 600 V and 5.5 A to 400 A.

Small, high-density package

The N8700 provides up to 5200 W in a small space-saving 2U high, 19-inch wide package. Its air vents are in the front and rear (not on the top or bottom), so you can stack other instruments directly above or below it to save valuable rack space.

Flexible AC input voltage options

The N8700 models offer flexible AC input voltage options. Every N8700 model can be purchased with either a 208 V 3-phase or 400 V 3-phase voltage input option. The 3.3 kW models have the additional option of a 230 V single-phase AC input voltage. Choose the one that best fits your operating environment. They also provide power factor correction.

Number of outputs		1	1	1	1	1	1
GPIB, LAN, USB		Yes	Yes	Yes	Yes	Yes	Yes
Output Ratings							
Voltage ¹		8 V	10 V	15 V	20 V	30 V	40 V
Current ²		400 A	330 A	220 A	165 A	110 A	85 A
Power		3200 W	3300 W	3300 W	3300 W	3300 W	3400 W
Programming accuracy							
Voltage ¹	0.05%+	4 mV	5 mV	7.5 mV	10 mV	15 mV	20 mV
Current ^{2, 6}	0.1%+	800 mA	660 mA	440 mA	330 mA	220 mA	170 mA
Output ripple and noise							
CV p-p (Up to 20 MHz)		60 mV	60 mV	60 mV	60 mV	60 mV	60 mV
CV rms (From 5 Hz – 1 MHz)		8 mV	8 mV	8 mV	8 mV	8 mV	8 mV
Measurement accuracy							
Voltage	0.1%+	8 mV	10 mV	15 mV	20 mV	30 mV	40 mV
Current ⁶	0.1%+	1200 mA	990 mA	660 mA	495 mA	330 mA	255 mA
Load effect							
CV load regulation ³		6.2 mV	6.5 mV	7.25 mV	8 mV	9.5 mV	11 mV
CC load regulation ⁴		85 mA	71 mA	49 mA	38 mA	27 mA	22 mA
Source effect							
CV line regulation ⁵		2.8 mV	3 mV	3.5 mV	4 mV	5 mV	6 mV
CC line regulation ⁵		42 mA	35 mA	24 mA	18.5 mA	13 mA	10.5 mA
Load transient recovery time							
Time ⁷		<1 ms	<1 ms	<1 ms	<1 ms	<1 ms	<1 ms

Notes:

- ¹ Minimum voltage is guaranteed to maximum 0.2% of rated output voltage.
 - ² Minimum current is guaranteed to maximum 0.4% of rated output current.
 - ³ From no-load to full-load, constant input voltage. Maximum drop in remote sense.
 - ⁴ For load voltage change equal to the unit voltage rating, constant input voltage
 - ⁵ Single-phase and 3-Phase 208 V models: 170~265 VAC, constant load.
3-Phase 400 V models: 342~460 VAC, constant load.
 - ⁶ The constant current programming readback and monitoring accuracy does not include the warm-up and load regulation thermal drift.
 - ⁷ Time for output voltage to recover within 0.5% of its rated output for a load change 10 - 90% of rated output current, local sense.
- * Rear panel with wire clamp connectors for 150 V to 600 V models (shown with 400 V 3-phase AC input option)

More detailed specifications at www.agilent.com/find/N8700

Single-Output 3.3-5.2 KW GPIB, LAN, USB (Continued)

Specifications

(at 0° to 55°C unless otherwise specified)

N8731A	N8732A	N8733A	N8734A	N8735A	N8736A
--------	--------	--------	--------	--------	--------

Supplemental Characteristics

(Non-warranted characteristics determined by design that are useful in applying the product)

Output response time

Up-prog response time ⁸	80 ms	80 ms	80 ms	80 ms	80 ms	80 ms
Down-prog response time Full-load ⁹	20 ms	100 ms	100 ms	100 ms	160 ms	160 ms
Down-prog response time No-load ⁹	500 ms	600 ms	700 ms	800 ms	900 ms	1000 ms
Remote sense compensation	2 V	2 V	2 V	2 V	5 V	5 V

Output ripple and noise

CC rms ¹⁰	1300 mA	1200 mA	880 mA	660 mA	300 mA	200 m
----------------------	---------	---------	--------	--------	--------	-------

Programming resolution Measurement resolution

Voltage	0.96 mV	1.2 mV	1.8 mV	2.4 mV	3.6 mV	4.8 mV
Current	48 mA	39.6 mA	26.4 mA	19.8 mA	13.2 mA	10.2 mA

Notes:

- ⁸ From 10% to 90% or 90% to 10% of rated output voltage, with rated, resistive load.
- ⁹ From 90% to 10% of rated output voltage.
- ¹⁰ For 8 V - 15 V models the ripple is measured from 2 V to rated output voltage and rated output current. For other models, the ripple is measured at 10 - 100% of rated output voltage and rated output current.

Agilent Models: N8731A-42A, N8754A-62A

Extensive device protection

To safeguard your device from damage, the N8700 series power supplies provide over-temperature, over-current and over-voltage protect (OVP) to shut down the power supply output when a fault occurs. They also offer an undervoltage limit (UVL) that prevents adjustment of the output voltage below a certain limit. The combination of UVL and OVP capabilities lets you create a protection window for sensitive load circuitry.

Simplify system connection

The N8700 offers many system oriented features to simplify and accelerate test system development. They support the industry standard SCPI commands and come standard with software drivers.

With built-in GPIB, Ethernet/LAN, and USB 2.0 interfaces, the N8700 gives you the flexibility to use your I/O interface of choice today and in the future.

Additionally, the built-in Web server lets you operate, configure, and monitor the N8700 remotely via a standard browser such as Microsoft® Internet Explorer.

Analog programming and monitoring

The output voltage and current can be programmed from zero to full scale by either an analog voltage 0 to 5 V or 0 to 10 V or by resistance of 0 to 5 kΩ or 0 to 10 kΩ.

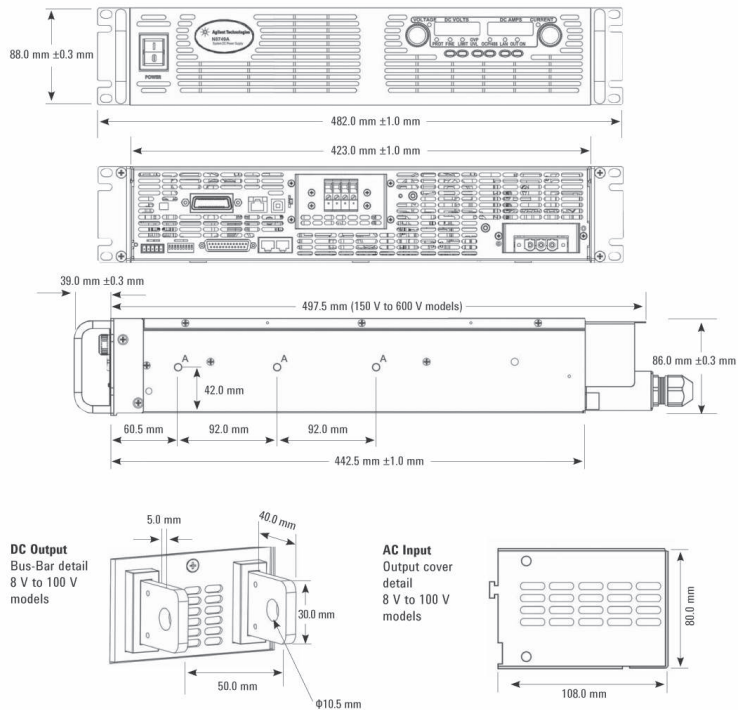

More detailed specifications at www.agilent.com/find/N8700

Single-Output 3.3-5.2 KW GPIB, LAN, USB (Continued)

Connect multiple units in parallel and series

Should you need greater output power, the N8700 series power supplies give you the flexibility to connect in parallel up to four identical units (same model number) for greater output current or connect two identical units (same model number) in series for greater output voltage (see output terminal isolation information).

Fan speed control

Lab bench use is enhanced by the fan speed control, which helps to minimize the acoustic noise.

Application notes

Selecting DC Sources for Telecommunications Equipment Test Systems
5990-4370EN

Power Sources for Energy-Efficient High Input Voltage Telecommunications Equipment Development
5990-4371EN

Notes:

- ¹ Minimum voltage is guaranteed to maximum 0.2% of rated output voltage.
- ² Minimum current is guaranteed to maximum 0.4% of rated output current.
- ³ From no-load to full-load, constant input voltage. Maximum drop in remote sense.
- ⁴ For load voltage change equal to the unit voltage rating, constant input voltage
- ⁵ Single-phase and 3-Phase 208 V models: 170~265 VAC, constant load. 3-Phase 400 V models: 342~460 VAC, constant load.
- ⁶ The constant current programming readback and monitoring accuracy does not include the warm-up and load regulation thermal drift.
- ⁷ Time for output voltage to recover within 0.5% of its rated output for a load change 10 - 90% of rated output current, local sense.
- ⁸ From 10% to 90% or 90% to 10% of rated output voltage, with rated, resistive load.
- ⁹ From 90% to 10% of rated output voltage.
- ¹⁰ For 8 V - 15 V models the ripple is measured from 2 V to rated output voltage and rated output current. For other models, the ripple is measured at 10 - 100% of rated output voltage and rated output current.

Specifications (at 0° to 55°C unless otherwise specified)	N8737A	N8738A	N8739A	N8740A	N8741A	N8742A
Number of outputs	1	1	1	1	1	1
GPIB, LAN, USB	Yes	Yes	Yes	Yes	Yes	Yes
Output ratings						
Voltage ¹	60 V	80 V	100 V	150 V	300 V	600 V
Current ²	55 A	42 A	33 A	22 A	11 A	5.5 A
Power	3300 W	3360 W	3300 W	3300 W	3300 W	3300 W
Programming accuracy						
Voltage ¹	0.05%+	30 mV	40 mV	50 mV	75 mV	150 mV
Current ^{2, 6}	0.1%+	110 mA	84 mA	66 mA	44 mA	22 mA
Output ripple and noise						
CV p-p (Up to 20 MHz)	60 mV	80 mV	100 mV	100 mV	300 mV	500 mV
CV rms (From 5 Hz – 1 MHz)	8 mV	25 mV	25 mV	25 mV	100 mV	120 mV
Measurement accuracy						
Voltage	0.1%+	60 mV	80 mV	100 mV	150 mV	300 mV
Current ⁶	0.1%+	165 mA	126 mA	99 mA	66 mA	33 mA
Load effect						
CV load regulation ³	14 mV	17 mV	20 mV	27.5 mV	50 mV	95 mV
CC load regulation ⁴	16 mA	13.4 mA	11.6 mA	9.4 mA	7.2 mA	6.1 mA
Source effect						
CV line regulation ⁵	8 mV	10 mV	12 mV	17 mV	32 mV	62 mV
CC line regulation ⁵	7.5 mA	6.2 mA	5.3 mA	4.2 mA	3.1 mA	2.6 mA
Load transient recovery time						
Time ⁷	≤ 1 ms	≤ 1 ms	≤ 1 ms	≤ 2 ms	≤ 2 ms	≤ 2 ms

Supplemental Characteristics

(Non-warranted characteristics determined by design that are useful in applying the product)

Supplemental Characteristics	N8737A	N8738A	N8739A	N8740A	N8741A	N8742A
Output response time						
Up-prog response time ⁸	150 ms	150 ms	150 ms	150 ms	150 ms	250 ms
Down-prog response time Full-load ⁸	160 ms	300 ms	300 ms	300 ms	300 ms	500 ms
Down-prog response time No-load ⁹	1100 ms	1200 ms	1500 ms	2000 ms	3500 ms	4000 ms
Remote sense compensation	5 V	5 V	5 V	5 V	5 V	5 V
Output ripple and noise						
CC rms ¹⁰	100 mA	80 mA	70 mA	60 mA	20 mA	10 mA
Programming resolution						
Measurement resolution						
Voltage	7.2 mV	9.6 mV	12 mV	18 mV	36 mV	72 mV
Current	6.6 mA	5 mA	4 mA	2.6 mA	1.3 mA	0.66 mA

More detailed specifications at www.agilent.com/find/N8700

Single-Output 3.3-5.2 KW GPIB, LAN, USB (Continued)

Specifications (at 0° to 55°C unless otherwise specified)	N8754A	N8755A	N8756A	N8757A	N8758A
Number of outputs	1	1	1	1	1
GPIB	Yes	Yes	Yes	Yes	Yes
Output ratings					
Voltage ¹	20 V	30 V	40 V	60 V	80 V
Current ²	250 A	170 A	125 A	85 A	65 A
Power	5000 W	5100 W	5000 W	5100 W	5200 W
Programming accuracy					
Voltage ¹	0.025% +	15 mV	22.5 mV	30 mV	45 mV
Current ^{2,6}	0.1% +	750 mA	510 mA	375 mA	255 mA
Output ripple and noise					
CV p-p (Up to 20 MHz)	75 mV	75 mV	75 mV	75 mV	100 mV
CV rms (From 5 Hz – 1 MHz)	10 mV	10 mV	10 mV	10 mV	15 mV
Measurement accuracy					
Voltage	0.025% +	25 mV	37.5 mV	50 mV	75 mV
Current ⁶	0.15% +	750 mA	510 mA	375 mA	255 mA
Load effect					
CV load regulation ³	8 mV	9.5 mV	11 mV	14 mV	17 mV
CC load regulation ⁴	250 mA	170 mA	125 mA	85 mA	65 mA
Source effect					
CV line regulation ⁵	2 mV	3 mV	4 mV	6 mV	8 mV
CC line regulation ⁵	125 mA	85 mA	62.5 mA	42.5 mA	32.5 mA
Load transient recovery time					
Time ⁷	<1 ms	<1 ms	<1 ms	<1 ms	<1 ms
Supplemental Characteristics (Non-warranted characteristics determined by design and useful in applying the product)					
Output response time					
Up-prog response time ⁸	30 ms	30 ms	30 ms	50 ms	50 ms
Down-prog response time Full-load ⁸	50 ms	80 ms	80 ms	80 ms	100 ms
Down-prog response time No-load ⁹	700 ms	800 ms	900 ms	1000 ms	1200 ms
Remote sense compensation	2 V	5 V	5 V	5 V	5 V
Output ripple and noise					
CC rms ¹⁰	1000 mA	460 mA	300 mA	150 mA	120 mA
Programming resolution					
Measurement resolution					
Voltage	2.4 mV	3.6 mV	4.8 mV	7.2 mV	9.6 mV
Current	30 mA	20.4 mA	15 mA	10.2 mA	7.8 mA

Supplemental characteristics for all model numbers

Command response time: Average time required for the output voltage to begin to change following receipt of digital data is 100 ms.

Output terminal isolation:

8 V to 60 V units

No output terminal may be more than ±60 VDC from any other terminal or chassis ground

80 V to 600 V units

No positive output terminal may be more than ± 600 VDC from any other terminal or chassis ground.

No negative output terminal may be more than ± 400 VDC from any other terminal or chassis ground.

Modulation: (Analog programming of output voltage and current)

Input signal: selectable, 0 to 5 V/0 to 10 V full scale

Input impedance: selectable, 0 to 5 kΩ/0 to 10 kΩ full scale

I/O interface: GPIB, LAN, USB standard

Software driver:

- IVI-COM
- LabVIEW

AC input:

Input range:

230 VAC single-phase option
170 - 265 VAC; 47 - 63 Hz;
3.3 kW models only

208 VAC 3-phase option
170 - 265 VAC; 47 - 63 Hz

400 VAC 3-phase option
342 - 460 VAC; 47 - 63 Hz

Input current:

230 VAC single-phase
3.3 kW models only: 23 - 24 A Max @ 100% load

208 VAC 3-phase option
3.3 kW models: 13.6 - 14.5 A Max @ 100% load
5 kW models: 21-22 A max @ 100% load

400 VAC 3-phase option
3.3 kW models: 6.8 - 7.2 A Max @ 100% load
5 kW models: 10.5 - 12 A Max @ 100% load

Notes:

- 1 Minimum voltage is guaranteed to maximum 0.2% of rated output voltage.
- 2 Minimum current is guaranteed to maximum 0.4% of rated output current.
- 3 From no-load to full-load, constant input voltage. Maximum drop in remote sense.
- 4 For load voltage change equal to the unit voltage rating, constant input voltage
- 5 Single-phase and 3-Phase 208 V models: 170~265 VAC, constant load.
3-Phase 400 V models: 342~460 VAC, constant load.

⁶ The constant current programming readback and monitoring accuracy does not include the warm-up and load regulation thermal drift.

⁷ Time for output voltage to recover within 0.5% of its rated output for a load change 10 - 90% of rated output current, local sense.

⁸ From 10% to 90% or 90% to 10% of rated output voltage, with rated, resistive load.

⁹ From 90% to 10% of rated output voltage.

¹⁰ For 8 V - 15 V models the ripple is measured from 2 V to rated output voltage and rated output current. For other models, the ripple is measured at 10 - 100% of rated output voltage and rated output current.

More detailed specifications at www.agilent.com/find/N8700

Single-Output 3.3-5.2 KW GPIB, LAN, USB (Continued)

Power factor: 230 VAC single-phase option 3.3 kW models only: 0.99 at nominal input and rated output power
208 & 400 VAC 3-phase options 3.3 kW models: 0.95 at nominal input and rated output power
5 kW models: 0.94 at nominal input and rated output power

Regulatory compliance: European EMC directive 89/336/EEC for Class A products, Australian C-Tick mark, this ISM device complies with Canadian ICES-001. Cet appareil ISM est conforme à la norme NMB-001 du Canada. European Low Voltage Directive 73/23/EEC.

Size: 88 mm H x 423 mm W x 442.5 mm D (3.46 in x 16.65 in x 17.42 in), excluding connectors and handles

Weight: Net, 3.3 kW – 13 Kg (28.6 lbs); 5 kW – 16 Kg (35.2 lbs)

Warranty: Three years

Ordering information

Opt 861 Unterminated line cord for 208 V 3-phase AC input voltage (Option 208)

Opt 862 Unterminated line cord for 400 V 3-phase AC input voltage (Option 400)

Opt 831 Unterminated line cord for 230 V single-phase AC input voltage (Option 230)

Opt 832 Unterminated, harmonized line cord for Europe for 230 V single-phase AC input voltage (Option 230)

Opt 208 190-240 V, 3-phase AC, 50/60 Hz input (use with line cord Opt 861)

Opt 400 380-415 V, 3-phase AC, 50/60 Hz input (use with line cord Opt 862)

Opt 230 190-240 V, single-phase AC, 50/60 Hz input (use with line cord Opt 831 or 832)

Accessories for all N8700 Models

N5740A Rack mount slide kit (required for rack mounting; standard system rack mounting hardware will not work).

Specifications

(at 0° to 55°C unless otherwise specified)

	N8759A	N8760A	N8761A	N8762A
Number of outputs	1	1	1	1
GPIB	No	No	No	No
Output ratings				
Voltage ¹	100 V	150 V	300 V	600 V
Current ²	50 A	34 A	17 A	8.5 A
Power	5000 W	5100 W	5100 W	5100 W
Programming accuracy				
Voltage ¹	0.025%+	75 mV	112.5 mV	225 mV
Current ^{2, 6}	0.1% +	150 mA	102 mA	51 mA
Output ripple and noise				
CV p-p (Up to 20 MHz)	100 mV	120 mV	300 mV	500 mV
CV rms (From 5 Hz – 1 MHz)	15 mV	25 mV	60 mV	120 mV
Measurement accuracy				
Voltage	0.025%+	125 mV	187.5 mV	375 mV
Current ⁶	0.1%+	150 mA	102 mA	51 mA
Load effect				
CV load regulation ³	20 mV	27.5 mV	50 mV	95 mV
CC load regulation ⁴	50 mA	34 mA	17 mA	8.5 mA
Source effect				
CV line regulation ⁵	10 mV	15 mV	30 mV	60 mV
CC line regulation ⁵	25 mA	17 mA	8.5 mA	4.3 mA
Load transient recovery time				
Time ⁷	<1 ms	<2 ms	<2 ms	<2 ms

Supplemental Characteristics (Non-warranted characteristics determined by design and useful in applying the product)

	N8759A	N8760A	N8761A	N8762A
Output response time				
Up-prog response time ⁸	50 ms	50 ms	50 ms	100 ms
Down-prog response time Full-load ⁸	100 ms	100 ms	100 ms	200 ms
Down-prog response time No-load ⁹	1500 ms	2000 ms	2500 ms	3000 ms
Remote sense compensation	5 V	5 V	5 V	5 V
Output ripple and noise				
CC rms ¹⁰	100 mA	90 mA	30 mA	15 mA
Programming resolution				
Measurement resolution				
Voltage	12 mV	18 mV	36 mV	72 mV
Current	6 mA	4.1 mA	2 mA	1 mA

Notes:

- Minimum voltage is guaranteed to maximum 0.2% of rated output voltage.
- Minimum current is guaranteed to maximum 0.4% of rated output current.
- From no-load to full-load, constant input voltage. Maximum drop in remote sense.
- For load voltage change equal to the unit voltage rating, constant input voltage
- Single-phase and 3-Phase 208 V models: 170~265 VAC, constant load. 3-Phase 400 V models: 342~460 VAC, constant load.
- The constant current programming readback and monitoring accuracy does not include the warm-up and load regulation thermal drift.
- Time for output voltage to recover within 0.5% of its rated output for a load change 10 - 90% of rated output current, local sense.
- From 10% to 90% or 90% to 10% of rated output voltage, with rated, resistive load.
- From 90% to 10% of rated output voltage.
- For 8 V - 15 V models the ripple is measured from 2 V to rated output voltage and rated output current. For other models, the ripple is measured at 10 - 100% of rated output voltage and rated output current.

More detailed specifications at www.agilent.com/find/N8700

Single-Output, Autoranging 5, 10, 15 KW GPIB, LAN (LXI core), USB

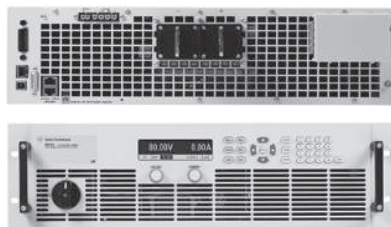

N8920A-N8924A, N8925A-N8930A
N8931A-N8937A, N8940A-N8944A
N8945A-N8950A, N8951A-N8957A

- Autoranging output - does the job of multiple power supplies
- Up to 1500 V and up to 510 A
- Built-in measurements and advanced programmable features
- Protection from over-voltage, over-current, and over-temperature
- Parallel units to create "one" power supply with greater than 100 kW of power
- Small high density 3U package

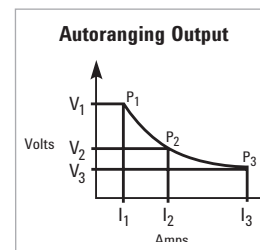

Specifications (at 0° to 55°C unless otherwise specified)	N8920A N8940A	N8921A N8941A	N8923A N8943A	N8924A N8944A
--	------------------	------------------	------------------	------------------

Family of affordable, autoranging system DC power supplies
The Agilent Technologies N8900 Series provides 5, 10, and 15 kW autoranging, single-output programmable DC power for ATE applications that require just the right amount of performance at just the right price. The N8900 Series power supplies' autoranging output characteristic enables unprecedented flexibility by offering a wide range of voltage and current combinations at full power. Power supplies with "rectangular," or traditional, output characteristics provide full power at only one voltage and current combination. Just one N8900 does the job of multiple power supplies. It's like having many power supplies in one!

The N8900 Series provides stable output power, built-in voltage and current measurements, and autoranging output voltage and current from 80 to 1500 V and 10 to 510 A. These supplies offer many system-ready features like multiple standard I/O interfaces to simplify and accelerate test-system development and compact 3U design to save rack space.

Number of outputs	1	1	1	1
GPIB, LAN, USB	Yes	Yes	Yes	Yes
DC ratings				
Voltage	0 to 80 V	0 to 200 V	0 to 500 V	0 to 750 V
Current	0 to 170 A	0 to 70 A	0 to 30 A	0 to 20 A
Power	5000 W	5000 W	5000 W	5000 W
Output ripple and noise				
CV peak to peak ¹	200 mV	300 mV	350 mV	800 mV
CV rms ²	16 mV	40 mV	70 mV	200 mV
Load effect (change from 0% to 100% of full load)				
Voltage	40 mV	100 mV	250 mV	375 mV
Current	255 mA	105 mA	45 mA	30 mA
Programming accuracy				
Voltage	≤ 80 mV	≤ 200 mV	≤ 500 mV	≤ 750 mV
Current	≤ 340 mA	≤ 140 mA	≤ 60 mA	≤ 40 mA
Measurement accuracy				
Voltage	≤ 80 mV	≤ 200 mV	≤ 500 mV	≤ 750 mV
Current	≤ 340 mA	≤ 140 mA	≤ 60 mA	≤ 40 mA
Load transient response				
Recovery time ³	≤ 1.5 ms	≤ 1.5 ms	≤ 1.5 ms	≤ 1.5 ms

Notes: All specifications apply to >2% of voltage and >1% of current

¹ 20 MHz

² 20 Hz to 300 kHz

³ Time for output voltage to recover within 1% of its rated output for a load change from 10% to 90% of its rated output current)

Single-Output Autoranging 5, 10, 15 KW GPIB, LAN (LXI core), USB (Continued)

Specifications (at 0° to 55°C unless otherwise specified)	N8920A N8940A	N8921A N8941A	N8923A N8943A	N8924A N8944A
--	------------------	------------------	------------------	------------------

If more power is required, easily parallel multiple N8900 units to create “one” power supply with > 100 kW of total output power. The built-in master/slave control enables programming as if it’s just one big power supply; no need to program each supply individually.

Easy front-panel operation

Using the front panel controls, you have complete access to all of the N8900 features via the extensive menu system. You can either use the voltage and current knobs or enter your settings via the keypad. You can also set protection settings, power-on states, and other features. The output voltage, current, and power can be displayed simultaneously, and annunciators at the bottom of the display show power supply status and operating modes. You can lock the front panel controls to protect against accidental power-supply parameter changes.

Device protection

To safeguard your device, the N8900 Series power supplies provide over-temperature, over-current and over-voltage protection to shut down the power supply output when a fault condition occurs.

Supplemental Characteristics

(Non-warranted characteristics determined by design that are useful in applying the product)

Output response time (total voltage excursion)				
10% to 90%, at full load ¹	≤ 30 ms	≤ 30 ms	≤ 30 ms	≤ 30 ms
90% to 10%, at full load ¹	≤ 80 ms	≤ 80 ms	≤ 80 ms	≤ 80 ms
90% to 10%, at no load	≤ 30 s	≤ 10 s	≤ 10 s	≤ 10 s
Command response time	< 25 ms	< 25 ms	< 25 ms	< 25 ms
Current ripple & noise				
CC rms	80 mA	22 mA	16 mA	16 mA
Remote sense compensation				
Volts/load lead	2 V	5 V	10 V	18 V
Over-voltage protection range	88 V	220 V	550 V	825 V
Source effect (±10% of AC input rating)				
Voltage	16 mV	40 mV	100 mV	150 mV
Current	85 mA	35 mA	15 mA	10 mA
Output terminal isolation	300 V	300 V	300 V	300 V
208 VAC input				
Voltage	187 to 240 VAC	187 to 240 VAC	187 to 240 VAC	187 to 240 VAC
Current	2 x 32 A	2 x 32 A	2 x 32 A	2 x 32 A
400 VAC input				
Voltage	340 to 460 VAC	340 to 460 VAC	340 to 460 VAC	340 to 460 VAC
Current	2 x 16 A	2 x 16 A	2 x 16 A	2 x 16 A
208 & 400 VAC input				
Frequency	50/60 Hz	50/60 Hz	50/60 Hz	50/60 Hz
Number phases	3 phase	3 phase	3 phase	3 phase
Power factor	>0.99	>0.99	>0.99	>0.99

Notes:

¹ For purposes of Output Response Time, full load occurs at the full range output voltage and the maximum output current available at the full output voltage

Single-Output Autoranging 5, 10, 15 KW GPIB, LAN (LXI core), USB (Continued)

Specifications <small>(at 0° to 55°C unless otherwise specified)</small>	N8925A N8945A	N8926A N8946A	N8928A N8948A	N8929A N8949A	N8930A N8950A
Number of outputs	1	1	1	1	1
GPIB, LAN, USB	Yes	Yes	Yes	Yes	Yes
DC ratings					
Voltage	0 to 80 V	0 to 200 V	0 to 500 V	0 to 750 V	0 to 1000 V
Current	0 to 340 A	0 to 140 A	0 to 60 A	0 to 40 A	0 to 30 A
Power	10000 W	10000 W	10000 W	10000 W	10000 W
Output ripple and noise					
CV peak to peak ¹	320 mV	300 mV	350 mV	800 mV	1600 mV
CV rms ²	25 mV	40 mV	70 mV	120 mV	350 mV
Load effect (change from 0% to 100% of full load)					
Voltage	40 mV	100 mV	250 mV	375 mV	500 mV
Current	510 mA	210 mA	90 mA	60 mA	45 mA
Programming accuracy					
Voltage	≤ 80 mV	≤ 200 mV	≤ 500 mV	≤ 750 mV	≤ 1 V
Current	≤ 680 mA	≤ 280 mA	≤ 120 mA	≤ 80 mA	≤ 60 mA
Measurement accuracy					
Voltage	≤ 80 mV	≤ 200 mV	≤ 500 mV	≤ 750 mV	≤ 1 V
Current	≤ 680 mA	≤ 280 mA	≤ 120 mA	≤ 80 mA	≤ 60 mA
Load transient response					
Recovery time ³	≤ 1.5 ms	≤ 1.5 ms	≤ 1.5 ms	≤ 1.5 ms	≤ 1.5 ms

Autoranging output – does the job of multiple power supplies
 The N8900 power supplies’ autoranging output characteristic makes it much more flexible than rectangular, or traditional, output characteristic power supplies because they expand the power curve, giving the user more voltage and current combinations in one power supply. It’s like having many rectangular power supplies in one. For example, the 1000 V, 30 A, 10 kW model is capable of 1000 V and 10 A at 10 kW as well as 333.3 V and 30 A at 10 kW. If it were a rectangular output, the specifications would be 1000 V, 10 A, 10 kW. At 333.3 V it would only be able to output 3.3 kW, not the 10 kW of an autoranging output. Figures 1 and 2 show a graphical representation of this example.

Simplify system connections
 The N8900 Series power supplies comes standard with GPIB, Ethernet/LAN, USB 2.0, and analog interfaces giving you the flexibility to use your I/O interface of choice today and safeguard your test setup for the future. There is no need to worry whether or not you are choosing the right interface when they all come standard. The N8900 is fully compliant with the LXI Core specification.

Remote access and control
 The built-in Web server provides remote access and control of the instrument via a standard browser. This control goes above and beyond the LXI specification, giving users the ability to monitor and control the instrument from anywhere. Using the Web browser, you can set up, monitor and operate the N8900 remotely.

Notes: All specifications apply to >2% of voltage and >1% of current

¹ 20 MHz

² 20 Hz to 300 kHz

³ Time for output voltage to recover within 1% of its rated output for a load change from 10% to 90% of its rated output current

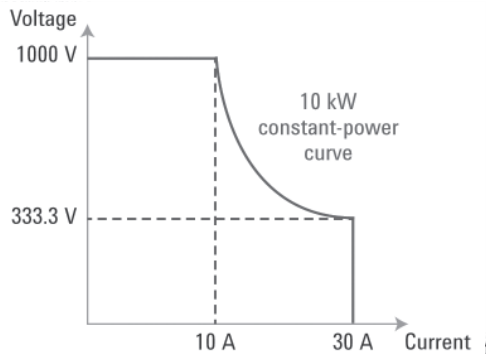

Figure 1. Autoranging output characteristic

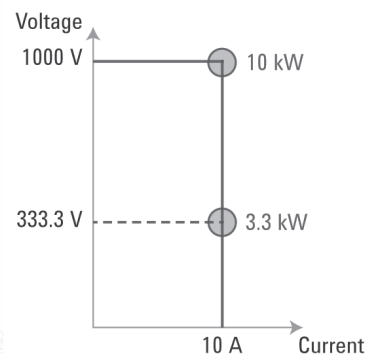

Figure 2. Rectangular output characteristic

Single-Output Autoranging 5, 10, 15 KW GPIB, LAN (LXI core), USB (Continued)

Specifications (at 0° to 55°C unless otherwise specified)	N8925A N8945A	N8926A N8946A	N8928A N8948A	N8929A N8949A	N8930A N8950A
--	------------------	------------------	------------------	------------------	------------------

Easy system integration and configuration

To simplify system development, the N8900 comes standard with IVI-COM drivers. The N8900 supports the easy-to-use SCPI (Standard Commands for Programmable Instruments).

Analog programming and monitoring

The output voltage and current can be programmed from zero to full-scale by an analog voltage signal from 0 to 5 V or 0 to 10 V. Each corresponding to 0 to 100% of full-scale. The measured output voltage and current can also be monitored in the same way.

Supplemental Characteristics	(Non-warranted characteristics determined by design that are useful in applying the product)				
Output response time (total voltage excursion)					
10% to 90%, of full load ¹	≤ 30 ms	≤ 30 ms	≤ 30 ms	≤ 30 ms	≤ 30 ms
90% to 10%, of full load ¹	≤ 80 ms	≤ 80 ms	≤ 80 ms	≤ 80 ms	≤ 80 ms
90% to 10%, at no load	≤ 30 s	≤ 10 s	≤ 10 s	≤ 10 s	≤ 10 s
Command response time	< 25 ms	< 25 ms	< 25 ms	< 25 ms	< 25 ms
Current ripple & noise					
CC rms	160 mA	44 mA	32 mA	32 mA	22 mA
Remote sense compensation					
Volts/load lead	2 V	5 V	10 V	18 V	22 V
Over-voltage protection range	88 V	220 V	550 V	825 V	1100 V
Source effect (±10% of AC input rating)					
Voltage	16 mV	40 mV	100 mV	150 mV	200 mV
Current	170 mA	70 mA	30 mA	20 mA	15 mA
Output terminal isolation	300 V	300 V	300 V	300 V	300 V
208 VAC input					
Voltage	187 to 240 VAC	187 to 240 VAC	187 to 240 VAC	187 to 240 VAC	187 to 240 VAC
Current	2 x 32 A, 1 x 56 A	2 x 32 A, 1 x 56 A	2 x 32 A, 1 x 56 A	2 x 32 A, 1 x 56 A	2 x 32 A, 1 x 56 A
400 VAC input					
Voltage	340 to 460 VAC	340 to 460 VAC	340 to 460 VAC	340 to 460 VAC	340 to 460 VAC
Current	2 x 16 A, 1 x 28 A	2 x 16 A, 1 x 28 A	2 x 16 A, 1 x 28 A	2 x 16 A, 1 x 28 A	2 x 16 A, 1 x 28 A
208 & 400 VAC input					
Frequency	50/60 Hz	50/60 Hz	50/60 Hz	50/60 Hz	50/60 Hz
Number phases	3 phase	3 phase	3 phase	3 phase	3 phase
Power factor	>0.99	>0.99	>0.99	>0.99	>0.99

Notes:

¹ For purposes of Output Response Time, full load occurs at the full range output voltage and the maximum output current available at the full output voltage

Single-Output Autoranging 5, 10, 15 KW GPIB, LAN (LXI core), USB (Continued)

Parallel operation for more power

Need more power, we've got you covered. Quickly create a master/slave setup for even more total output power. The N8900 Series power supplies give you the flexibility to easily connect in parallel up to seven identical units (same model number) for greater output current. The units can also be configured to look like "one" big power supply.

AC input

The N8900 has 28 total models. Fourteen have 208 VAC inputs and the remaining 14 have 400 VAC inputs. This gives the N8900 the ability to be used anywhere in the world. Choose 208 VAC for regions such as the Americas and Japan or choose 400 VAC for regions such as Europe and Asia.

Specifications (at 0° to 55°C unless otherwise specified)	N8931A N8951A	N8932A N8952A	N8934A N8954A	N8935A N8955A	N8937A N8957A
Number of outputs	1	1	1	1	1
GPIB, LAN, USB	Yes	Yes	Yes	Yes	Yes
DC ratings					
Voltage	0 to 80 V	0 to 200 V	0 to 500 V	0 to 750 V	0 to 1500 V
Current	0 to 510 A	0 to 210 A	0 to 90 A	0 to 60 A	0 to 30 A
Power	15000 W	15000 W	15000 W	15000 W	15000 W
Output ripple and noise					
CV peak to peak ¹	320 mV	300 mV	350 mV	800 mV	2400 mV
CV rms ²	25 mV	40 mV	70 mV	200 mV	400 mV
Load effect (change from 0% to 100% of full load)					
Voltage	40 mV	100 mV	250 mV	375 mV	750 mV
Current	765 mA	315 mA	135 mA	90 mA	45 mA
Programming accuracy					
Voltage	≤ 80 mV	≤ 200 mV	≤ 500 mV	≤ 750 mV	≤ 1.5 V
Current	≤ 1.1 A	≤ 420 mA	≤ 180 mA	≤ 120 mA	≤ 60 mA
Measurement accuracy					
Voltage	≤ 80 mV	≤ 200 mV	≤ 500 mV	≤ 750 mV	≤ 1.5 V
Current	≤ 1.1 A	≤ 420 mA	≤ 180 mA	≤ 120 mA	≤ 60 mA
Transient response					
Recovery time ³	≤ 1.5 ms	≤ 1.5 ms	≤ 1.5 ms	≤ 1.5 ms	≤ 1.5 ms

Notes: All specifications apply to >2% of voltage and >1% of current

¹ 20 MHz

² 20 Hz to 300 kHz

³ Time for output voltage to recover within 1% of its rated output for a load change from 10% to 90% of its rated output current

Single-Output Autoranging 5, 10, 15 KW GPIB, LAN (LXI core), USB (Continued)

Specifications (at 0° to 55°C unless otherwise specified)	N8931A N8951A	N8932A N8952A	N8934A N8954A	N8935A N8955A	N8937A N8957A
--	------------------	------------------	------------------	------------------	------------------

Supplemental Characteristics (Non-warranted characteristics determined by design that are useful in applying the product)

Output response time (total voltage excursion)					
10% to 90%, of full load ¹	≤ 30 ms	≤ 30 ms	≤ 30 ms	≤ 30 ms	≤ 30 ms
90% to 10%, of full load ¹	≤ 80 ms	≤ 80 ms	≤ 80 ms	≤ 80 ms	≤ 80 ms
90% to 10%, at no load	≤ 30 s	≤ 10 s	≤ 10 s	≤ 10 s	≤ 10 s
Command response time	< 25 ms	< 25 ms	< 25 ms	< 25 ms	< 25 ms
Current ripple & noise					
CC rms	240 mA	66 mA	48 mA	48 mA	26 mA
Remote sense compensation					
Volts/load lead	2 V	5 V	10 V	18 V	30 V
Over-voltage protection range	88 V	220 V	550 V	825 V	1650 V
Source effect (±10% of AC input rating)					
Voltage	16 mV	40 mV	100 mV	150 mV	300 mV
Current	255 mA	105 mA	45 mA	30 mA	15 mA
Output terminal isolation	300 V	300 V	300 V	300 V	300 V
208 VAC input					
Voltage	187 to 240 VAC	187 to 240 VAC	187 to 240 VAC	187 to 240 VAC	187 to 240 VAC
Current	3 x 56 A	3 x 56 A	3 x 56 A	3 x 56 A	3 x 56 A
400 VAC input					
Voltage	340 to 460 VAC	340 to 460 VAC	340 to 460 VAC	340 to 460 VAC	340 to 460 VAC
Current	3 x 28 A	3 x 28 A	3 x 28 A	3 x 28 A	3 x 28 A
208 & 400 VAC input					
Frequency	50/60 Hz	50/60 Hz	50/60 Hz	50/60 Hz	50/60 Hz
Number phases	3 phase	3 phase	3 phase	3 phase	3 phase
Power factor	>0.99	>0.99	>0.99	>0.99	>0.99

Notes:

¹ For purposes of Output Response Time, full load occurs at the full range output voltage and the maximum output current available at the full output voltage

Single-Output Autoranging 5, 10, 15 KW GPIB, LAN (LXI core), USB (Continued)

Weight and dimensions

400 VAC models

Shipping Container size

L 961 mm x W 676 mm x H 343 mm

Shipping Weight

N8940-44A: 29 kg

N8945-50A: 36 kg

N8951-57A: 44 kg

Product dimensions

L 610 mm x W 449 mm x H 133 mm

Product weight

N8940-44A: 17 kg

N8945-50A: 23.9 kg

N8951-57A: 30.9 kg

208 VAC models

Shipping Container size

L 961 mm x W 676 mm x H 343 mm

Shipping Weight

N8940-44A: 30 kg

N8945-50A: 39 kg

N8951-57A: 47 kg

Product dimensions

L 670 mm x W 449 mm x H 133 mm

Product weight

N8940-44A: 18.5 kg

N8945-50A: 26.4 kg

N8951-57A: 34.2 kg

Warranty: 3 years

Ordering information

Accessories and Options

TBD

AC Input Voltages

If the AC input voltage where the power supply will be used is:

187 to 240 VAC please choose a 208 VAC model (N8920A-N8937A)

340 to 460 VAC please choose a 400 VAC model (N8940A-N8957A)

Line Cords and Terminations (Plugs)

Due to the number of different line cords and terminations around the world, the N8900 power supplies do not come with line cords or terminations. Users will need to supply their own dependent on the local laws and codes of the country/region where the power supply will be used.

High Performance DC Power Supplies...

speed and accuracy for test optimization

Agilent high performance DC power supplies provide the features and performance necessary to satisfy the most demanding requirements. For system designers who are striving to shorten test time and maximize production throughput, the Agilent high performance DC power supplies will help them achieve their goals.

Multiple output power supplies reduce rack space. The advanced programmable capabilities allow for efficient system design and maintenance. Also their programming and measurement accuracy, and their DUT protection features, make them an excellent value for the R&D lab.

Comparison Summary	Agilent basic DC power supplies	Agilent high performance DC power supplies
Output power	30 W-1500 W	40 W-6600 W
Number of outputs	1-3	1-8
GPIB programming and measurement speed	Moderate	Fast
Output rise/fall time	Moderate	Fast
Convenient 1/2 rack-size for bench-top use	Yes	No
Active downprogrammer for enhanced test throughput	No	Yes
Stored wake-up state	No	Yes
Programmable capabilities	Moderate	Extensive
Protection for the DUT	Moderate	Extensive

More detailed specifications at www.agilent.com/find/power



6611C - 6614C

Single-Output 40-50 W GPIB

- Small, compact size for bench and system use
- Fast, low-noise outputs
- Dual-range, precision low current measurement
- Built-in measurements and advanced programmable features
- Protection features to ensure DUT safety

This series of linear-regulated 40-50 W DC power supplies is designed to maximize the throughput of DUTs through the manufacturing test process with fast programming and measurement, and also active downprogramming. It offers many advanced programmable features including stored states and status reporting. Programming is done using industry standard SCPI commands via the GPIB or RS-232. Test system integration is further simplified by using the VXIPlug&Play drivers. The optional relays simplify system design and troubleshooting.

The half-rack size of the 6610C series makes it a convenient DC power supply for the R&D lab bench. The built-in microamp measurement system helps the engineer to easily and accurately monitor the output voltage and current without a complicated test setup.

Application notes

10 Practical Tips You Need to Know About Your Power Products
5965-8239E

10 Hints for Using Your Power Supply to Decrease Test Time
5968-6359E

Understanding Linear Power Supply Operation (AN1554)
5989-2291EN

Specifications

(at 0° to 55°C unless otherwise specified)

	6611C	6612C	6613C	6614C	6611C-J05 Special order option	
Number of outputs	1	1	1	1	1	
GPIB	Yes	Yes	Yes	Yes	Yes	
Output ratings						
Voltage	0 to 8 V	0 to 20 V	0 to 50 V	0 to 100 V	0 to 10 V	
Current	0 to 5 A	0 to 2 A	0 to 1 A	0 to 0.5 A	0 to 5 A	
Programming accuracy (at 25°C ±5°C)						
Voltage	0.05% +	5 mV	10 mV	20 mV	50 mV	5 mV
+Current	0.05% +	2 mA	1 mA	0.75 mA	0.5 mA	2 mA
Ripple and noise 20 Hz to 20 MHz, with outputs ungrounded or with either terminal grounded						
Voltage	rms	0.5 mV	0.5 mV	0.5 mV	0.6 mV	0.5 mV
	peak-to-peak	3 mV	3 mV	4 mV	5 mV	3 mV
Normal mode	rms	2 mA	1 mA	1 mA	1 mA	2 mA
DC measurement accuracy via GPIB or front-panel meters with respect to actual output at 25°C ±5°C						
Voltage	0.03% +	2 mV	3 mV	6 mV	12 mV	2 mV
Low current range -20 mA to +20 mA	0.1% +	2.5 μA	2.5 μA	2.5 μA	2.5 μA	2.5 μA
High current range +20 mA to + rated I	0.2% +	0.5 mA	0.25 mA	0.2 mA	0.1 mA	0.5 mA
	-20 mA to - rated I	0.2% +	1.1 mA	0.85 mA	0.8 mA	0.7 mA
Load regulation						
Voltage		2 mV	2 mV	4 mV	5 mV	2 mV
Current		1 mA	0.5 mA	0.5 mA	0.5 mA	1 mA
Line regulation						
Voltage		0.5 mV	0.5 mV	1 mV	1 mV	0.5 mV
Current		0.5 mA	0.5 mA	0.25 mA	0.25 mA	0.5 mA
Transient response time Less than 100 μs for the output to recover to its previous level (within 0.1% of the voltage rating of the supply or 20 mV, whichever is greater) following any step change in load current of up to 50% of the output current rating of the supply						
Supplemental Characteristics		(Non-warranted characteristics determined by design and useful in applying the product)				
Average programming resolution						
Voltage		2 mV	5 mV	12.5 mV	25 mV	3 mV
Current		1.25 mA	0.5 mA	0.25 mA	0.125 mA	1.25 mA
Sink current		-3 A	-1.2 A	-0.6 A	-0.3 A	-3 A

Single-Output: 40-50 W GPIB (Continued)

Supplemental characteristics for all model numbers

DC floating voltage: Output terminals can be floated up to ± 240 VDC maximum from chassis ground

Remote sensing: Up to two volts dropped in each load lead. Add 2 mV to the voltage load regulation specification for each one volt change in the positive output lead due to load current change.

Command processing time: Average time required for the output voltage to begin to change following receipt of digital data is 4 ms for the power supplies connected directly to the GPIB.

Output programming response time: The rise and fall time (10/90% and 90/10%) of the output voltage is less than 2 ms. The output voltage change settles within 1 LSB (0.025% x rated voltage) of final value in less than 6 ms.

GPIB interface capabilities: IEEE-488.2, SCPI command set, and 6630A Series programming compatibility

Input power: (full load): 1.6 A, 100 W (6611C: 2.2 A, 120 W)

Regulatory compliance: Complies with EMC directive 89/336/EEC (ISM 1B).

Software driver:
VXIPlug&Play

Size: 212.8 mm W x 88.1 mm H x 368.3 mm D (8.4 in x 3.5 in x 14.5 in)

Weight: 8.2 kg (18.16 lb) net;
10.6 kg (23.5 lb) shipping

Warranty: Three years

Ordering information

- Opt 100** 87 to 106 VAC, 47 to 63 Hz
- Opt 120** 104 to 127 VAC, 47 to 63 Hz
- Opt 220** 191 to 233 VAC, 47 to 63 Hz
- Opt 230** 207 to 253 VAC, 47 to 63 Hz
- Opt 760** Isolation and reversal relays
- Opt 0L1** English printed users and programming guide (full documentation on CD-ROM)
- Opt 0B0** English printed service manual

Accessories

- * **1CM002A** Rack mount flange kit 88.1 mm H (2U), 1.5 inch hole space for side by side mounting of two units. Requires lock link kit (and support rails)
- 5061-9694** Lock link kit
- * **1CM024A** Rack mount flange kit 88.1 mm H (2U), one bracket, one half-module bracket, and filler panel
- E3663AC** Support rails for Agilent rack cabinets
- * Support rails required

Agilent Models: 6611C, 6612C, 6613C, 6614C

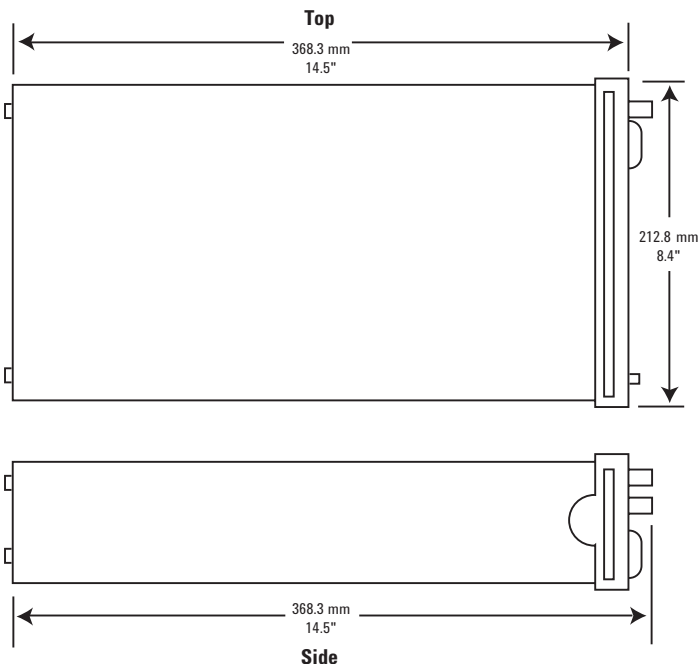
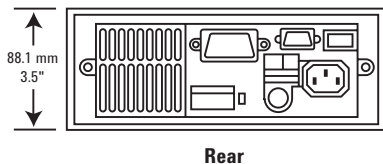

More detailed specifications at www.agilent.com/find/6610

Single-Output 80-100 W GPIB

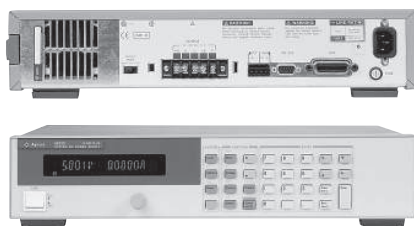

6631B - 6634B

- Fast, low-noise outputs
- Programmable active down-programmer sinks the full rated current
- Dual-range, precision low current measurement
- Optional isolation and polarity reversal relays
- Built-in measurements and advanced programmable features
- Protection features to ensure DUT safety

Specifications

(at 0° to 55°C unless otherwise specified)

6631B 6632B 6633B 6634B

This series of linear-regulated 80-100 W DC power supplies is designed to maximize the throughput of DUTs through the manufacturing test process. Both programming and measurement are optimized for speed. The active downprogrammer can sink up to the full rated current of the power supply, which quickly brings the power supply output to zero volts. The 6630B series offers many advanced programmable features including stored states and status reporting. Programming is done using industry standard SCPI commands via the GPIB or RS-232. Test system integration is further simplified by using the *VXIPlug&Play* drivers. The optional relays simplify system design and troubleshooting.

The optional front panel binding posts make the 6630B series convenient on the R&D lab bench. The built-in microamp measurement system helps the engineer to easily and accurately monitor the output voltage and current without a complicated test setup.

Application notes

10 Practical Tips You Need to Know About Your Power Products
5965-8239E

10 Hints for Using Your Power Supply to Decrease Test Time
5968-6359E

		6631B	6632B	6633B	6634B
Number of outputs		1	1	1	1
GPIB		Yes	Yes	Yes	Yes
Output ratings					
Voltage		0 to 8 V	0 to 20 V	0 to 50 V	0 to 100 V
Current		0 to 10 A	0 to 5 A	0 to 2 A	0 to 1 A
Programming accuracy at 25°C ±5°C					
Voltage		5 mV	10 mV	20 mV	50 mV
+ Current		0.05% +	4 mA	2 mA	1 mA
Ripple and noise (20 Hz to 20 MHz, with outputs ungrounded or with either terminal grounded)					
Voltage normal mode		rms peak-to-peak	0.3 mV 3 mV	0.3 mV 3 mV	0.5 mV 3 mV
Fast mode		rms peak-to-peak	1 mV 10 mV	1 mV 10 mV	1 mV 15 mV
Current		rms	3 mA	2 mA	2 mA
DC measurement accuracy via GPIB or front panel meters with respect to actual output at 25°C ±5°C					
Voltage		0.03% +	2 mV	3 mV	6 mV
Low current range		-20 mA to +20 mA 0.1% +	2.5 µA	2.5 µA	2.5 µA
High current range		+20 mA to +rated I 0.2% + -20 mA to -rated I 0.2% +	1 mA 1.6 mA	0.5 mA 1.1 mA	0.25 mA 0.85 mA
Load regulation					
Voltage			2 mV	2 mV	4 mV
Current			2 mA	1 mA	1 mA
Line regulation					
Voltage			0.5 mV	0.5 mV	1 mV
Current			1 mA	0.5 mA	0.25 mA
Transient response time Less than 100 µs (50 µs in the fast mode) for the output voltage to recover to its previous level (within 0.1% of the voltage rating of the supply or 20 mV) following any step change in load current of up to 50% of the output current rating of the supply.					

Understanding Linear Power Supply Operation (AN1554)
5989-2291EN

More detailed specifications at www.agilent.com/find/6630

Single-Output: 80-100 W GPIB (Continued)

Specifications (at 0° to 55°C unless otherwise specified)	6631B	6632B	6633B	6634B
--	-------	-------	-------	-------

Supplemental characteristics for all model numbers

DC floating voltage: Output terminals can be floated up to ±240 VDC maximum from chassis ground

Remote sensing: Up to two volts dropped in each load lead. Add 2 mV to the voltage load regulation specification for each one volt change in the positive output lead due to load current change.

Command processing time: Average time required for the output voltage to begin to change following receipt of digital data is 4 ms for the power supplies connected directly to the GPIB. (Display disabled).

Output programming response time: The rise and fall time (10/90% and 90/10%) of the output voltage is less than 2 ms (400 µs in fast mode). The output voltage change settles within 1 LSB (0.025% x rated voltage) of final value in less than 6 ms (2 ms in the fast mode).

GPIB interface capabilities: IEEE-488.2, SCPI command set and 6630A Series programming compatibility

Software driver: VXIPlug&Play

Measurement time: Average time to make a voltage or current measurement is 50 ms.

Input power (full load): 3.5 A, 250 W

Regulatory compliance: Complies with EMC directive 89/336/EEC (ISM 1B).

Size: 425.5 mm W x 88.1 mm H x 364.4 mm D (16.8 in x 3.5 in x 14.3 in).

Weight: Net, 12.7 kg (28 lb) net; 15.0 kg (33 lb) shipping

Warranty: Three years

Supplemental Characteristics

(Non-warranted characteristics determined by design and useful in applying the product)

Average programming resolution				
Voltage	2 mV	5 mV	12.5 mV	25 mV
Current	2.5 mA	1.25 mA	0.5 mA	0.25 mA
Sink current	10 A	5 A	2 A	1 A
Sink current tracking				
SCPI mode	0.4% + 4 mA	0.4% + 2 mA	0.4% + 1 mA	0.4% + 0.5 mA
Compatibility mode	-500 mA	-250 mA	-100 mA	-50 mA
Minimum current in constant current mode*	40 mA	20 mA	8 mA	4 mA

*When programming in the 6630A Series language compatibility mode.

Ordering Information

- Opt 100 87 to 106 VAC, 47 to 63 Hz
- Opt 120 104 to 127 VAC, 47 to 63 Hz
- Opt 220 191 to 233 VAC, 47 to 63 Hz
- Opt 230 207 to 253 VAC, 47 to 63 Hz
- Opt 020 Front-panel binding posts (N/A on 6631B)
- Opt 760 Isolation and reversal relays, only available at time of order (N/A on 6631B)
- Opt 0L1 English printed users and programming guide (full documentation on CD-ROM)
- Opt 0B3 English printed service manual

Accessories

- * 1CM002A Rack mount flange kit 88.1 mm H (2U), two flange brackets: 1.75 inch hole spacing
- * 1CP001A Rack mount flange and handle kit 88.1 mm H (2U), two brackets and front handles
- p/n 1494-0060 Rack slide kit
- E3663AC Support rails for Agilent rack cabinets
- * Support rails required

Agilent Models: 6631B, 6632B, 6633B, 6634B

Terminal Strip Detail

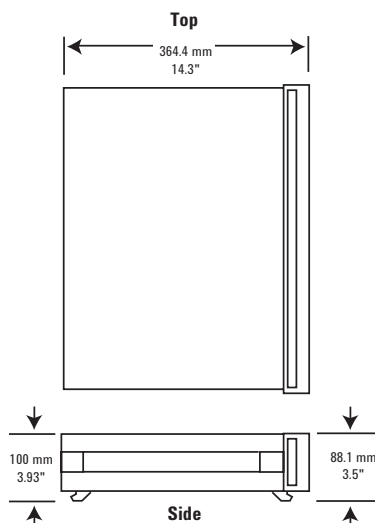
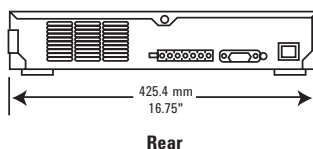
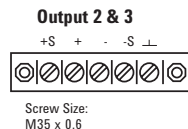

More detailed specifications at www.agilent.com/find/6630

Single-Output 200 W

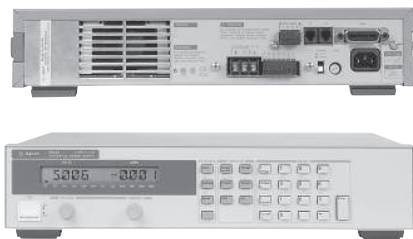

6641A - 6645A

- Fast, low-noise outputs
- Analog control of output voltage and current
- Fan-speed control to minimize acoustic noise
- Parallel and series connections of multiple units
- Built-in measurements and advanced programmable features
- Protection features to ensure DUT safety

Specifications

(at 0° to 55°C unless otherwise specified)

	6641A	6642A	6643A	6644A	6645A	
Number of outputs	1	1	1	1	1	
 GPIB 	Yes	Yes	Yes	Yes	Yes	
Output ratings						
Output voltage	0 to 8 V	0 to 20 V	0 to 35 V	0 to 60 V	0 to 120 V	
Output current (40°C)	0 to 20 A	0 to 10 A	0 to 6 A	0 to 3.5 A	0 to 1.5 A	
Maximum current (50°C/55°C)	18 A/17 A	9 A/8.5 A	5.4 A/5.1 A	3.2 A/3 A	1.4 A/1.3 A	
Programming accuracy at 25°C ±5°C						
Voltage	0.06% + 5 mV	10 mV	15 mV	26 mV	51 mV	
Current	0.15% + 26 mA	13 mA	6.7 mA	4.1 mA	1.7 mA	
Ripple and noise from 20 Hz to 20 MHz						
Voltage	rms	300 µV	300 µV	400 µV	500 µV	700 µV
	peak-peak	3 mV	3 mV	4 mV	5 mV	7 mV
Current	rms	10 mA	5 mA	3 mA	1.5 mA	1 mA
Readback accuracy at 25°C ±5°C (percent of reading plus fixed)						
Voltage	0.07% + 6 mV	15 mV	25 mV	40 mV	80 mV	
+Current	0.15% + 18 mA	9.1 mA	5 mA	3 mA	1.3 mA	
-Current	0.35% + 40 mA	20 mA	12 mA	6.8 mA	2.9 mA	
Load regulation						
Voltage	1 mV	2 mV	3 mV	4 mV	5 mV	
Current	1 mA	0.5 mA	0.25 mA	0.25 mA	0.25 mA	
Line regulation						
Voltage	0.5 mV	0.5 mV	1 mV	1mV	2 mV	
Current	1 mA	0.5 mA	0.25 mA	0.25 mA	0.25 mA	
Transient response time Less than 100 µs for the output voltage to recover to its previous level (within 0.1% of the voltage rating of the supply or 20 mV, whichever is greater) following any step change in load current of up to 50% of rated current						
Supplemental Characteristics (Non-warranted characteristics determined by design and useful in applying the product)						
Average resolution						
Voltage	2 mV	5 mV	10 mV	15 mV	30 mV	
Current	6 mA	3 mA	2 mA	1.2 mA	0.5 mA	
OVP	13 mV	30 mV	54 mV	93 mV	190 mV	
OVP accuracy	160 mV	400 mV	700 mV	1.2 V	2.4 V	

This series of 200 W linear-regulated DC power supplies is designed to maximize the throughput of DUTs through the manufacturing test process with fast up and down programming time.

Valuable assemblies can be destroyed by a minor component failure that can allow a surge of voltage or current to flow to the DUT. Fast protection features, including fast crowbar, mode cross-over protection, and the ability to connect the protection circuitry of multiple power supplies can increase production yield.

Programming of the DC output and the protection features can be done either from the front panel or using industry standard SCPI commands, via the GPIB. Using the serial link, up to 16 power supplies can be connected through one GPIB address. Test system integration can be further simplified by using the *VXIPlug&Play* drivers. The output voltage and current can also be controlled with analog signals. This is helpful for certain types of noisy environments, and also immediate reactions to process changes.

Lab bench use is enhanced by the fan speed control, which helps to minimize the acoustic noise.

Single-Output: 200 W GPIB (Continued)

	Specifications (at 0° to 55°C unless otherwise specified)				
	6641A-J04 Special order option	6643A-J11 Special order option	6644A-J09 Special order option	6645A-J05 Special order option	6645A-J06 Special order option
Number of outputs	1	1	1	1	1
GPIB	Yes	Yes	Yes	Yes	Yes
Output ratings					
Output voltage	13 V	40 V	70 V	150 V	170 V
Output current (40°C)	15.3 A	5 A	3 A	1.2 A	1 A
Maximum current (50°C/55°C)	13.77 A/13 A	4.5 A/4.25 A	2.7 A/2.55 A	1.08 A/1.02 A	0.9 A/0.85 A
Programming accuracy at 25°C ±5°C					
Voltage	0.06% +	8.5 mV	17.5 mV	31 mV	65 mV
Current	0.15% +	21 mA	6.7 mA	4.1 mA	1.7 mA
Ripple and noise					
from 20 Hz to 20 MHz					
Voltage rms	300 µV	450 µV	600 µV	900 µV	1 mV
peak-peak	3 mV	3.5 mV	6 mV	9 mV	10 mV
Current rms	8 mA	3 mA	1.5 mA	1 mA	1 mA
Readback accuracy at 25°C ±5°C (percent of reading plus fixed)					
Voltage	0.07% +	10 mV	30 mV	47 mV	100 mV
+Current	0.15% +	15 mA	5 mA	3 mA	1.3 mA
-Current	0.35% +	40 mA	12 mA	6.8 mA	2.9 mA
Load regulation					
Voltage	1 mV	3 mV	4.5 mV	7 mV	8 mV
Current	1 mA	0.25 mA	0.25 mA	0.25 mA	0.25 mA
Line regulation					
Voltage	0.5 mV	1 mV	1.5 mV	2.5 mV	3 mV
Current	1 mA	0.25 mA	0.25 mA	0.25 mA	0.25 mA
Transient response time Less than 100 µs for the output voltage to recover to its previous level (within 0.1% of the voltage rating of the supply or 20 mV, whichever is greater) following any step change in load current of up to 50% of rated current					
Supplemental Characteristics (Non-warranted characteristics determined by design and useful in applying the product)					
Average resolution					
Voltage	3.5 mV	12 mV	1.4 mV	37.5 mV	42.5 mV
Current	5 mA	2 mA	1.2 mA	0.5 mA	0.5 mA
OVP	23 mV	62 mV	110 mV	250 mV	285 mV
OVP accuracy	260 mV	800 mV	1.5 mV	3 V	3.4 V

Application notes

10 Practical Tips You Need to Know About Your Power Products
5965-8239E

10 Hints for Using Your Power Supply to Decrease Test Time
5968-6359E

Understanding Linear Power Supply Operation (AN1554)
5989-2291EN

Modern Connectivity - Using USB and LAN I/O Converters (AN 1475-1)
5989-0123EN

Supplemental characteristics for all model numbers

DC floating voltage: Output terminals can be floated up to ±240 VDC from chassis ground

Remote sensing: Up to half the rated output voltage can be dropped in each load lead. The drop in the load leads subtracts from the voltage available for the load.

Command processing time: Average time required for the output voltage to begin to change following receipt of digital data is 20 ms for the power supplies connected directly to the GPIB

Output programming response time: The rise and fall time (10/90% and 90/10%) of the output voltage is less than 15 ms. The output voltage change settles within 1 LSB (0.025% x rated voltage) of final value in less than 60 ms.

Down programming: An active down programmer sinks approximately 20% of the rated output current

Modulation: (Analog programming of output voltage and current)
Input Signal: 0 to -5 V
Input Impedance: 10 kΩ nominal

Single-Output: 200 W GPIB (Continued)

AC input: (AC input frequency 47 to 63 Hz)

Voltage 100 VAC 120 VAC 220 VAC 240 VAC

Current 4.4 A 3.8 A 2.2 A 2.0 A

Input power 480 VA, 400 W at full load;
60 W at no load

GPIB interface capabilities SH1, AH1, T6, L4, SR1, RL1, PP0, DC1, DT1, E1, and C0. IEEE-488.2 and SCPI-compatible command set

Software driver:

- IVI-COM
- VXIPlug&Play

Regulatory compliance: Complies with UL 3111-1, IEC 61010-1.

Size: 425.5 mm W x 88.1 mm H x 439 mm D (16.75 in x 3.5 in x 17.3 in)

Weight: Net, 14.2 kg (31.4 lb); shipping, 16.3 kg (36 lb)

Warranty: Three years

Ordering information

Opt 100 87 to 106 VAC, 47 to 63 Hz

Opt 120 104 to 127 VAC, 47 to 63 Hz

Opt 220 191 to 233 VAC, 47 to 63 Hz

Opt 240 209 to 250 VAC, 47 to 63 Hz

Opt 0L1 English printed users and programming guide (full documentation on CD-ROM)

Opt 0B3 English printed service manual

Accessories

* **1CM002A** Rack mount flange kit 88.1 mm H (2U), 1.75 inch hole spacing, two flange brackets

* **1CP001A** Rack mount flange and handle kit 88.1 mm H (2U) – two brackets and front handles

p/n **1494-0060** Accessory slide kit

p/n **1252-3698** 7-pin analog plug

p/n **1252-1488** 4-pin digital plug

p/n **5080-2148** Serial link cable 2 m (6.6 ft)

E3663AC Support rails for Agilent rack cabinets

* Support rails required

Agilent Models: 6641A, 6642A, 6643A, 6644A, 6645A

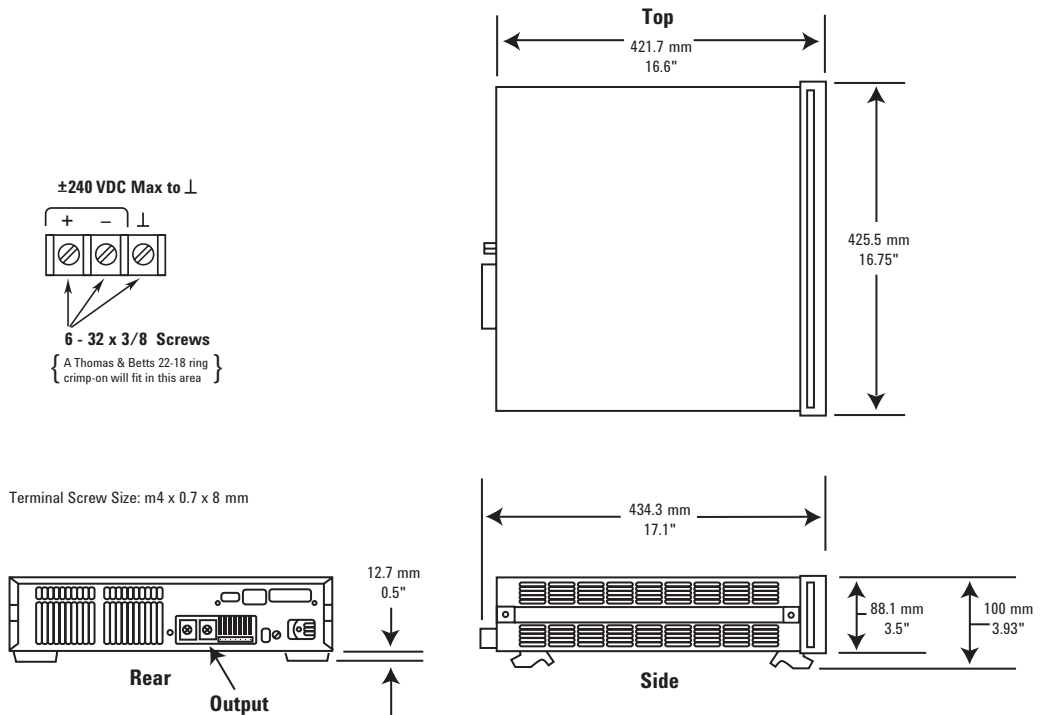

More detailed specifications at www.agilent.com/find/6640

Single-Output 200 W



6541A-6545A

- Front panel and analog control of output voltage and current
- Fast, low-noise outputs
- Fan-speed control to minimize acoustic noise
- Protection features to ensure DUT safety

This reliable series of 200 W DC power supplies can be controlled either from the front panel or via an analog programming voltage. When used in a test system, the fast up and down programming helps decrease test time. Quickly reacting protection features, including fast crowbar, CV/CC mode crossover and over-voltage protection help protect your valuable assemblies from damage. The linear topology produces very low ripple and noise, which allows you to make extremely accurate measurements of the devices which you are testing.

Lab bench use is enhanced by the fan speed control, which helps to minimize the acoustic noise.

Specifications

(at 0° to 55°C unless otherwise specified)

	6541A	6542A	6543A	6544A	6545A
Number of outputs	1	1	1	1	1
GPIB	No	No	No	No	No
Output ratings					
Output voltage	0 to 8 V	0 to 20 V	0 to 35 V	0 to 60 V	0 to 120 V
Output current (40°C)	0 to 20 A	0 to 10 A	0 to 6 A	0 to 3.5 A	0 to 1.5 A
Maximum current (50°C/55°C)	18 A/17 A	9 A/8.5 A	5.4 A/5.1 A	3.2 A/3 A	1.4 A/1.3 A
Programming accuracy at 25°C ±5°C					
Voltage	0.06% + 5 mV	10 mV	15 mV	26 mV	51 mV
Current	0.14% + 26 mA	13 mA	6.7 mA	4.1 mA	1.7 mA
Ripple and noise					
from 20 Hz to 20 MHz					
Voltage rms	300 µV	300 µV	400 µV	500 µV	700 µV
peak-peak	3 mV	3 mV	4 mV	5 mV	7 mV
Current rms	10 mA	5 mA	3 mA	1.5 mA	1 mA
Load regulation					
Voltage	1 mV	2 mV	3 mV	4 mV	5 mV
Current	1 mA	0.5 mA	0.25 mA	0.25 mA	0.25 mA
Line regulation					
Voltage	0.5 mV	0.5 mV	1 mV	1 mV	2 mV
Current	1 mA	0.5 mA	0.25 mA	0.25 mA	0.25 mA
Transient response time	Less than 100 µs for the output voltage to recover to its previous level (within 0.1% of the voltage rating of the supply or 20 mV, whichever is greater) following any step change in load current of up to 50% of rated current				
Supplemental Characteristics (Non-warranted characteristics determined by design and useful in applying the product)					
Average resolution					
Voltage	2 mV	5 mV	10 mV	15 mV	30 mV
Current	6 mA	3 mA	2 mA	1.2 mA	0.5 mA
OVP	13 mV	30 mV	54 mV	93 mV	190 mV
OVP accuracy	160 mV	400 mV	700 mV	1.2 V	2.4 V

Single-Output: 200 W (Continued)

Specifications (at 0° to 55°C unless otherwise specified)	6541A-J04 Special order option	6544A-J09 Special order option	6545A-J05 Special order option
Number of outputs	1	1	1
GPIB	No	No	No
Output ratings			
Output voltage	13 V	70 V	150 V
Output current (40°C)	15.3 A	3 A	1.2 A
Maximum current (50°C/55°C)	13.77 A/13 A	2.7 A/2.55 A	1.08 A/1.02 A
Programming accuracy at 25°C ±5°C			
Voltage	0.06% + 8.5 mV	31 mV	65 mV
Current	0.15% + 21 mA	4.1 mA	1.7 mA
Ripple and noise			
from 20 Hz to 20 MHz			
Voltage rms	300 µV	600 µV	900 µV
peak-peak	3 mV	6 mV	9 mV
Current rms	8 mA	1.5 mA	1 mA
Load regulation			
Voltage	1 mV	4.5 mV	7 mV
Current	1 mA	0.25 mA	0.25 mA
Line regulation			
Voltage	0.5 mV	1.5 mV	2.5 mV
Current	1 mA	0.25 mA	0.25 mA
Transient response time	Less than 100 µs for the output voltage to recover to its previous level (within 0.1% of the voltage rating of the supply or 20 mV, whichever is greater) following any step change in load current of up to 50% of rated current		
Supplemental Characteristics	(Non-warranted characteristics determined by design and useful in applying the product)		
Average resolution			
Voltage	3.5 mV	1.4 mV	37.5 mV
Current	5 mA	1.2 mA	0.5 mA
OVP	23 mV	110 mV	250 mV
OVP accuracy	260 mV	1.5 mV	3 V

Application notes

10 Practical Tips You Need to Know About Your Power Products
5965-8239E

Understanding Linear Power Supply Operation (AN1554)
5989-2291EN

Supplemental characteristics for all model numbers

DC floating voltage: Output terminals can be floated up to ±240 VDC from chassis ground

Remote sensing: Up to half the rated output voltage can be dropped in each load lead. The drop in the load leads subtracts from the voltage available for the load.

Output programming response time: The rise and fall time (10/90% and 90/10%) of the output voltage is less than 15 ms. The output voltage change settles within 1 LSB (0.025% x rated voltage) of final value in less than 60 ms.

Down programming: An active down programmer sinks approximately 20% of the rated output current

Modulation: (Analog programming of output voltage and current)
Input Signal: 0 to -5 V
Input Impedance: 10 kΩ nominal

AC input: (AC input frequency 47 to 63 Hz)

Voltage 100 VAC 120 VAC 220 VAC 240 VAC

Current 4.4 A 3.8 A 2.2 A 2.0 A

Input power: 480 VA, 400 W at full load; 60 W at no load

Regulatory compliance: Conforms to UL1244 and IEC 61010-1.

Size: 425.5 mm W x 88.1 mm H x 439 mm D (16.75 in x 3.5 in x 17.3 in)

Weight: Net, 14.2 kg (31.4 lb); shipping, 16.3 kg (36 lb)

Warranty: Three years

Single-Output: 200 W (Continued)

Ordering information

- Opt 100** 87 to 106 VAC, 47 to 63 Hz
- Opt 120** 104 to 127 VAC, 47 to 63 Hz
- Opt 220** 191 to 233 VAC, 47 to 63 Hz
- Opt 240** 209 to 250 VAC, 47 to 63 Hz
- Opt 0L1** English printed operating manual (full documentation on CD-ROM)
- Opt 0B3** English printed service manual

Accessories

- * **1CM002A** Rack mount flange kit
88.1 mm H (2U), 1.75 inch hole spacing,
two flange brackets
- * **1CP001A** Rack mount flange and handle
kit 88.1 mm H (2U) – two brackets and
front handles
- p/n 1494-0060** Accessory slide kit
- E3663AC** Support rails for
Agilent rack cabinets
- * Support rails required

Agilent Models: 6541A, 6542A, 6543A, 6544A, 6545A

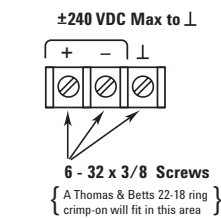

Terminal Screw Size: m4 x 0.7 x 8 mm

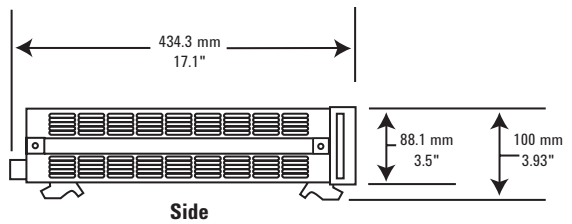
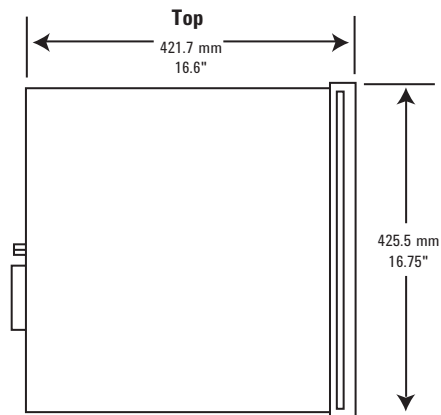
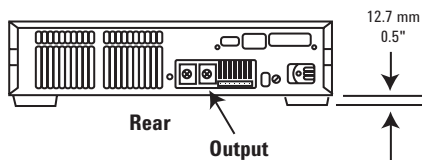

More detailed specifications at www.agilent.com/find/6540



6651A-6655A

Single-Output 500 W GPIB

- Fast, low-noise outputs
- Analog control of output voltage and current
- Fan-speed control to minimize acoustic noise
- Built-in measurements and advanced programmable features
- Protection features to ensure DUT safety

This series of 500 W linear-regulated DC power supplies is designed to maximize the throughput of DUTs through the manufacturing test process with fast up and down programming time.

Valuable assemblies can be destroyed by a minor component failure that causes a surge of current to flow into the DUT. Fast protection features, including fast crowbar, mode crossover protection, and the ability to connect the protection circuitry of multiple power supplies can increase production yield.

Programming of the DC output and the protection features can be done either from the front panel or using industry standard SCPI commands, via the GPIB. Using the serial link, up to 16 power supplies can be connected through one GPIB address. Test system integration can be further simplified by using the *VXIPlug&Play* drivers. The output voltage and current can also be controlled with analog signals. This is helpful for certain types of noisy environments, and also immediate reactions to process changes.

Lab bench use is enhanced by the fan speed control, which helps to minimize the acoustic noise.

Specifications

(at 0° to 55°C unless otherwise specified)

	6651A	6652A	6653A	6654A	6655A	6651A-J01 Special order option
Number of outputs	1	1	1	1	1	1
GPIB	Yes	Yes	Yes	Yes	Yes	Yes
Output ratings						
Output voltage	0 to 8 V	0 to 20 V	0 to 35 V	0 to 60 V	0 to 120 V	10 V
Output current (40°C)	0 to 50 A	0 to 25 A	0 to 15 A	0 to 9 A	0 to 4 A	50 A
Maximum current (50°C/55°C)	45 A/42.5 A	22.5 A/21.3 A	13.5 A/12.8 A	8.1 A/7.7 A	3.6 A/3.4 A	45 A/42.5 A
Programming accuracy at 25°C ±5°C						
Voltage	0.06% +	5 mV	10 mV	15 mV	26 mV	51 mV
Current	0.15% +	60 mA	25 mA	13 mA	8 mA	4 mA
Ripple and noise						
from 20 Hz to 20 MHz						
Voltage rms	300 µV	300 µV	400 µV	500 µV	700 µV	300 µV
peak-peak	3 mV	3 mV	4 mV	5 mV	7 mV	3 mV
Current rms	25 mA	10 mA	5 mA	3 mA	2 mA	25 mA
Readback accuracy at 25°C ±5°C (percent of reading plus fixed) System models only						
Voltage	0.07% +	6 mV	15 mV	25 mV	40 mV	80 mV
+Current	0.15% +	67 mA	26 mA	15 mA	7 mA	3 mA
-Current	0.35% +	100 mA	44 mA	24 mA	15 mA	7 mA
Load regulation						
Voltage	1 mV	2 mV	3 mV	4 mV	5 mV	1 mV
Current	2 mA	1 mA	0.5 mA	0.5 mA	0.5 mA	2 mA
Line regulation						
Voltage	0.5 mV	0.5 mV	1 mV	1 mV	2 mV	0.5 mV
Current	2 mA	1 mA	0.75 mA	0.5 mA	0.5 mA	2 mA
Transient response time	Less than 100 µs for the output voltage to recover to its previous level (within 0.1% of the voltage rating of the supply or 20 mV, whichever is greater) following any step change in load current of up to 50% of rated current					
Supplemental Characteristics	(Non-warranted characteristics determined by design and useful in applying the product)					
Average resolution						
Voltage	2 mV	5 mV	10 mV	15 mV	30 mV	2.5 mV
Current	15 mA	7 mA	4 mA	2.5 mA	1.25 mA	15 mA
OVP	12 mV	30 mV	54 mV	93 mV	190 mV	16 mV
OVP accuracy	160 mV	400 mV	700 mV	1.2 V	2.4 V	200 mV

More detailed specifications at www.agilent.com/find/6650

Single-Output: 500 W GPIB (Continued)

Application notes

10 Practical Tips You Need to Know About Your Power Products
5965-8239E

10 Hints for Using Your Power Supply to Decrease Test Time
5968-6359E

Understanding Linear Power Supply Operation
(AN1554)
5989-2291EN

Modern Connectivity - Using USB and LAN I/O Converters
(AN 1475-1)
5989-0123EN

Agilent DC Power Supplies for Base Station Testing
5988-2386EN

Specifications (at 0° to 55°C unless otherwise specified)	6651A-J03 Special order option	6651A-J09 Special order option	6652A-J03 Special order option	6653A-J04 Special order option	6653A-J17 Special order option
Number of outputs	1	1	1	1	1
GPIB	Yes	Yes	Yes	Yes	Yes
Output ratings					
Output voltage	6 V	17 V/20 V	27 V	40 V	30 V
Output current (40°C)	60 A	30 A/15 A	18.5 A	12.5 A	17.5 A
Maximum current (50°C/55°C)	54 A/51 A	27 A/25.5 A 13.5 A/12.75 A	16.65 A/15.72 A	11.25 A/10.6 A	15.75 A/14.87 A
Programming accuracy at 25°C ±5°C					
Voltage	0.06% +	5 mV	10 mV	13.5 mV	17.5 mV
Current	0.15% +	75 mA	36 mA	25 mA	13 mA
Ripple and noise					
from 20 Hz to 20 MHz					
Voltage rms	300 µV	300 µV	450 µV	1.6 mV	400 µV
peak-peak	3 mV	4 mV	4.5 mV	5 mV	4 mV
Current rms	30 mA	13 mA	10 mA	5 mA	6 mA
Readback accuracy at 25°C ±5°C (percent of reading plus fixed) System models only					
Voltage	0.07% +	6 mV	15 mV	20.5 mV	30 mV
+Current	0.15% +	80 mA	40 mA	26 mA	15 mA
-Current	0.35% +	150 mA	55 mA	44 mA	24 mA
Load regulation					
Voltage	1 mV	2 mV	2 mV	3.5 mV	3 mV
Current	6.5 mA	2 mA	1 mA	1 mA	0.5 mA
Line regulation					
Voltage	0.5 mV	0.5 mV	0.5 mV	1 mV	1 mV
Current	2 mA	2 mA	2 mA	0.75 mA	0.75 mA
Transient response time	Less than 100 µs for the output voltage to recover to its previous level (within 0.1% of the voltage rating of the supply or 20 mV, whichever is greater) following any step change in load current of up to 50% of rated current				
Supplemental Characteristics (Non-warranted characteristics determined by design and useful in applying the product)					
Average resolution					
Voltage	2 mV	5 mV	6.75 mV	12 mV	10 mV
Current	18 mA	9 mA	7 mA	4 mA	5 mA
OVP	12 mV	30 mV	30 mV	65 mV	54 mV
OVP accuracy	160 mV	500 mV	400 mV	750 mV	700 mV

Single-Output: 500 W GPIB (Continued)

Supplemental characteristics for all model numbers

DC floating voltage: Output terminals can be floated up to ±240 VDC from chassis ground

Remote sensing: Up to half the rated output voltage can be dropped in each load lead. The drop in the load leads subtracts from the voltage available for the load.

Command processing time: Average time required for the output voltage to begin to change following receipt of digital data is 20 ms for the power supplies connected directly to the GPIB

Output programming response time: The rise and fall time (10/90% and 90/10%) of the output voltage is less than 15 ms. The output voltage change settles within 1 LSB (0.025% x rated voltage) of final value in less than 60 ms.

Down programming: An active down programmer sinks approximately 20% of the rated output current

Modulation: (Analog programming of output voltage and current)
Input signal: 0 to -5 V
Input impedance: 10 kΩ nominal

AC input: (AC input frequency 47 to 63 Hz)
Voltage 100 VAC 120 VAC 220 VAC 240 VAC
Current 12 A 10 A 5.7 A 5.3 A

Input power: 1,380 VA, 1,100 W at full load; 120 W at no load

GPIB interface capabilities: SH1, AH1, T6, L4, SR1, RL1, PP0, DC1, DT1, E1, and C0. IEEE-488.2 and SCPI-compatible command set.

Software driver:
• IVI-COM
• VXIPlug&Play

Regulatory compliance: Listed to UL 1244; conforms to IEC 61010-1.

Size: 425.5 mm W x 132.6 mm H x 497.8 mm D (16.75 in x 5.22 in x 19.6 in)

Weight: Net, 25 kg (54 lb); shipping, 28 kg (61 lb)

Warranty: Three years

Specifications

(at 0° to 55°C unless otherwise specified)

	6654A-J04 Special order option	6654A-J05 Special order option	6654A-J12 Special order option	6655A-J05 Special order option	6655A-J10 Special order option
Number of outputs	1	1	1	1	1
GPIB	Yes	Yes	Yes	Yes	Yes
Output ratings					
Output voltage	70 V	50 V	80 V	150 V	156 V
Output current (40°C)	7.5 A	10 A	6 A	3.2 A	3 A
Maximum current (50°C/55°C)	6.75 A/6.37 A	9 A/8.5 A	5.4 A/5.1 A	2.88 A/2.72 A	2.7 A/2.55 A
Programming accuracy at 25°C ±5°C					
Voltage	0.06% +	30 mV	26 mV	35 mV	64 mV
Current	0.15% +	7 mA	9 mA	7 mA	3.5 mA
Ripple and noise from 20 Hz to 20 MHz					
Voltage rms	600 µV	500 µV	700 µV	800 µV	900 µV
peak-peak	6 mV	5 mV	7 mV	8 mV	8 mV
Current rms	5 mA	4 mA	3 mA	2 mA	3 mA
Readback accuracy at 25°C ±5°C (percent of reading plus fixed) System models only					
Voltage	0.07% +	50 mV	40 mV	58 mV	100 mV
+Current	0.15% +	6 mA	8 mA	6 mA	2.5 mA
-Current	0.35% +	13 mA	17 mA	16 mA	6.5 mA
Load regulation					
Voltage	4 mV	4 mV	4 mV	6 mV	7 mV
Current	0.5 mA	0.5 mA	0.5 mA	0.5 mA	1 mA
Line regulation					
Voltage	1 mV	1 mV	4.5 mV	2 mV	2 mV
Current	0.5 mA	0.5 mA	0.5 mA	0.5 mA	1 mA
Transient response time	Less than 100 µs for the output voltage to recover to its previous level (within 0.1% of the voltage rating of the supply or 20 mV, whichever is greater) following any step change in load current of up to 50% of rated current				
Supplemental Characteristics (Non-warranted characteristics determined by design and useful in applying the product)					
Average resolution					
Voltage	17.5 mV	15 mV	20 mV	37.5 mV	39.5 mV
Current	1.9 mA	2.75 mA	1.7 mA	8 mA	8 mA
OVP	110 mV	93 mV	130 mV	240 mV	250 mV
OVP accuracy	1.4 V	1.2 V	1.6 V	3 V	3.3 V

Single-Output: 500 W GPIB (Continued)

Ordering information

- Opt 100** 87 to 106 VAC, 47 to 63 Hz
- Opt 120** 104 to 127 VAC, 47 to 63 Hz
- Opt 220** 191 to 233 VAC, 47 to 63 Hz
- Opt 240** 209 to 250 VAC, 47 to 63 Hz
- Opt 0L1** English printed users and programming guide (full documentation on CD-ROM)
- Opt 0B3** English printed service manual

Accessories

- ***1CM003A** Rack mount flange kit
132.6 mm H (3U) – two flange brackets
 - ***1CP002A** Rack mount flange and handle kit
132.6 mm H (3U) – two brackets and front handles
 - p/n 1494-0059** Accessory slide kit
 - p/n 1252-3698** 7-pin analog plug
 - p/n 1252-1488** 4-pin digital plug
 - p/n 5080-2148** Serial link cable
2 m (6.6 ft)
 - E3663AC** Support rails for Agilent rack cabinets
- *Support rails required

Agilent Models: 6651A, 6652A, 6653A, 6654A, 6655A

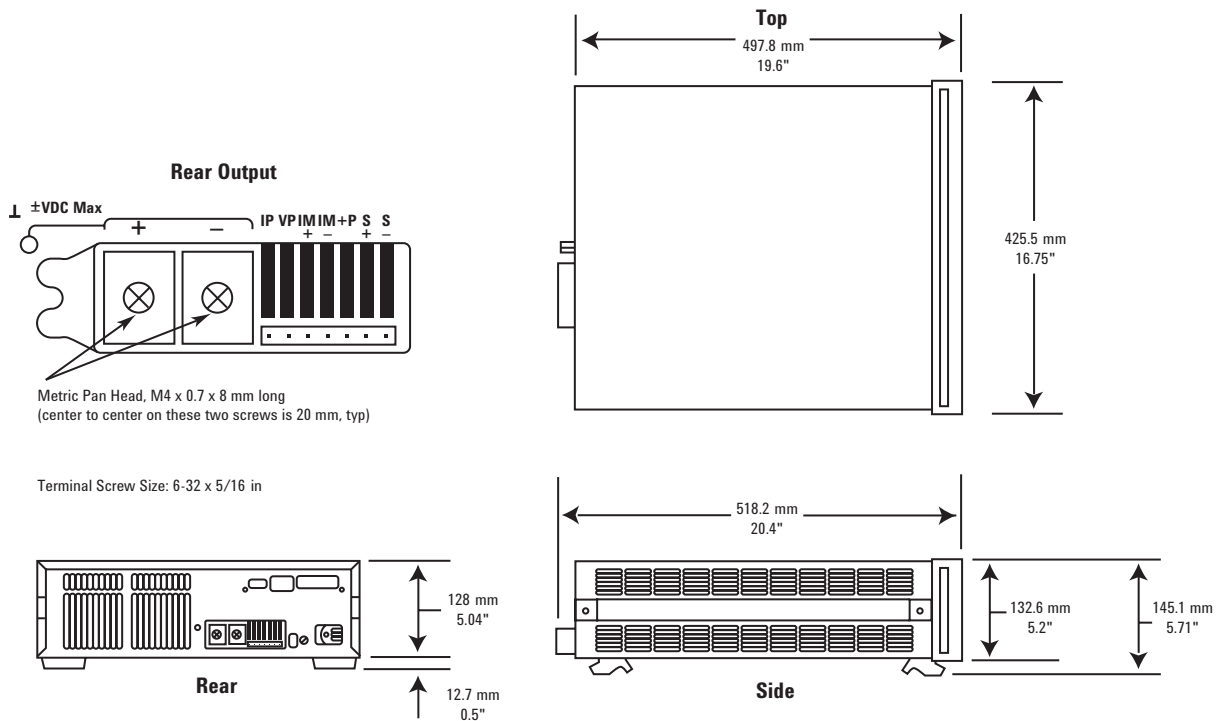

More detailed specifications at www.agilent.com/find/6650



6551A-6555A

Single-Output 500 W

- Front panel and analog control of output voltage and current
- Fast, low-noise outputs
- Fan-speed control to minimize acoustic noise
- Protection features to ensure DUT safety

Specifications

(at 0° to 55°C unless otherwise specified)

	6551A	6552A	6553A	6554A	6555A
Number of outputs	1	1	1	1	1
 GPIB 	No	No	No	No	No
Output ratings					
Output voltage	0 to 8 V	0 to 20 V	0 to 35 V	0 to 60 V	0 to 120 V
Output current (40°C)	0 to 50 A	0 to 25 A	0 to 15 A	0 to 9 A	0 to 4 A
Maximum current (50°C/55°C)	45 A/42.5 A	22.5 A/21.3 A	13.5 A/12.8 A	8.1 A/7.7 A	3.6 A/3.4 A
Programming accuracy at 25°C ±5°C					
Voltage	0.06% + 5 mV	10 mV	15 mV	26 mV	51 mV
Current	0.15% + 60 mA	25 mA	13 mA	8 mA	4 mA
Ripple and noise from 20 Hz to 20 MHz					
Voltage rms	300 µV	300 µV	400 µV	500 µV	700 µV
peak-peak	3 mV	3 mV	4 mV	5 mV	7 mV
Current rms	25 mA	10 mA	5 mA	3 mA	2 mA
Load regulation					
Voltage	1 mV	2 mV	3 mV	4 mV	5 mV
Current	2 mA	1 mA	0.5 mA	0.5 mA	0.5 mA
Line regulation					
Voltage	0.5 mV	0.5 mV	1 mV	1 mV	2 mV
Current	2 mA	1 mA	0.75 mA	0.5 mA	0.5 mA
Transient response time	Less than 100 µs for the output voltage to recover to its previous level (within 0.1% of the voltage rating of the supply or 20 mV, whichever is greater) following any step change in load current of up to 50% of rated current				
Supplemental Characteristics (Non-warranted characteristics determined by design and useful in applying the product)					
Average resolution					
Voltage	2 mV	5 mV	10 mV	15 mV	30 mV
Current	15 mA	7 mA	4 mA	2.5 mA	1.25 mA
OVP	12 mV	30 mV	54 mV	93 mV	190 mV
OVP accuracy	160 mV	400 mV	700 mV	1.2 V	2.4 V

This reliable series of 500 W DC power supplies can be controlled either from the front panel or via an analog programming voltage. When used in a test system, the fast up and down programming helps decrease test time. Quickly reacting protection features, including fast crowbar, CV/CC mode crossover and over-voltage protection help protect your valuable assemblies from damage. The linear topology produces very low ripple and noise, which allows you to make extremely accurate measurements of the devices which you are testing.

Lab bench use is enhanced by the fan speed control, which helps to minimize the acoustic noise.

Single-Output: 500 W (Continued)

Application notes

10 Practical Tips You Need to Know About Your Power Products
5965-8239E

Understanding Linear Power Supply Operation
(AN1554)
5989-2291EN

Agilent DC Power Supplies for Base Station Testing
5988-2386EN

Specifications

(at 0° to 55°C unless otherwise specified)

	6551A-J01 Special order option	6551A-J03 Special order option	6553A-J04 Special order option	6553A-J17 Special order option
Number of outputs	1	1	1	1
GPIO	No	No	No	No
Output ratings				
Output voltage	10 V	6 V	40 V	30 V
Output current (40°C)	50 A	60 A	12.5 A	17.5 A
Maximum current (50°C/55°C)	45 A/42.5 A	54 A/51 A	11.25 A/10.6 A	15.75 A/14.87 A
Programming accuracy at 25°C ±5°C				
Voltage	0.06% + 6 mV	5 mV	17.5 mV	15 mV
Current	0.15% + 60 mA	75 mA	13 mA	16 mA
Ripple and noise from 20 Hz to 20 MHz				
Voltage rms	300 µV	300 µV	1.6 mV	400 µV
peak-peak	3 mV	3 mV	5 mV	4 mV
Current rms	25 mA	30 mA	5 mA	6 mA
Load regulation				
Voltage	1 mV	1 mV	3.5 mV	3 mV
Current	2 mA	6.5 mA	1 mA	0.5 mA
Line regulation				
Voltage	0.5 mV	0.5 mV	1 mV	1 mV
Current	2 mA	2 mA	0.75 mA	0.75 mA
Transient response time	Less than 100 µs for the output voltage to recover to its previous level (within 0.1% of the voltage rating of the supply or 20 mV, whichever is greater) following any step change in load current of up to 50% of rated current			
Supplemental Characteristics (Non-warranted characteristics determined by design and useful in applying the product)				
Average resolution				
Voltage	2.5 mV	2 mV	12 mV	10 mV
Current	15 mA	18 mA	4 mA	5 mA
OVP	16 mV	12 mV	65 mV	54 mV
OVP accuracy	200 mV	160 mV	750 mV	700 mV

Single-Output: 500 W (Continued)

Supplemental characteristics for all model numbers

DC floating voltage: Output terminals can be floated up to ± 240 VDC from chassis ground

Remote sensing: Up to half the rated output voltage can be dropped in each load lead. The drop in the load leads subtracts from the voltage available for the load.

Output programming response time: The rise and fall time (10/90% and 90/10%) of the output voltage is less than 15 ms. The output voltage change settles within 1 LSB (0.025% x rated voltage) of final value in less than 60 ms.

Down programming: An active down programmer sinks approximately 20% of the rated output current

Modulation: (Analog programming of output voltage and current)
Input signal: 0 to -5 V
Input impedance: 10 k Ω nominal

AC input: (AC input frequency 47 to 63 Hz)
Voltage 100 VAC 120 VAC 220 VAC 240 VAC
Current 12 A 10 A 5.7 A 5.3 A

Input power: 1,380 VA, 1,100 W at full load; 120 W at no load

Regulatory compliance: Listed to UL 1244; certified to CSA556B; conforms to IEC 61010-1.

Size: 425.5 mm W x 132.6 mm H x 497.8 mm D (16.75 in x 5.22 in x 19.6 in)

Weight: Net, 25 kg (54 lb); shipping, 28 kg (61 lb)

Warranty: Three years

Specifications

(at 0° to 55°C unless otherwise specified)

	6554A-J04 Special order option	6554A-J05 Special order option	6554A-J12 Special order option	6555A-J10 Special order option
Number of outputs	1	1	1	1
GPIO	No	No	No	No
Output ratings				
Output voltage	70 V	50 V	80 V	156 V
Output current (40°C)	7.5 A	10 A	6 A	3 A
Maximum current (50°C/55°C)	6.75 A/6.37 A	9 A/8.5 A	5.4 A/5.1 A	2.7 A/2.55 A
Programming accuracy at 25°C $\pm 5^\circ\text{C}$				
Voltage	0.06% + 38 mV	26 mV	35 mV	71 mV
Current	0.15% + 7 mA	9 mA	7 mA	4 mA
Ripple and noise from 20 Hz to 20 MHz				
Voltage rms	600 μV	500 μV	700 μV	900 μV
peak-peak	6 mV	5 mV	5 mV	8 mV
Current rms	5 mA	4 mA	3 mA	3 mA
Load regulation				
Voltage	4 mV	4 mV	4 mV	7 mV
Current	0.5 mA	0.5 mA	0.5 mA	1 mA
Line regulation				
Voltage	1 mV	1 mV	4.5 mV	2 mV
Current	0.5 mA	0.5 mA	0.5 mA	1 mA
Transient response time				
	Less than 100 μs for the output voltage to recover to its previous level (within 0.1% of the voltage rating of the supply or 20 mV, whichever is greater) following any step change in load current of up to 50% of rated current			
Supplemental Characteristics (Non-warranted characteristics determined by design and useful in applying the product)				
Average resolution				
Voltage	17.5 mV	15 mV	20 mV	39.5 mV
Current	1.9 mA	2.75 mA	1.7 mA	8 mA
OVP	110 mV	93 mV	130 mV	250 mV
OVP accuracy	1.4 V	1.2 V	1.6 V	3.3 V

Single-Output: 500 W (Continued)

Ordering Information

- Opt 100** 87 to 106 VAC, 47 to 63 Hz
- Opt 120** 104 to 127 VAC, 47 to 63 Hz
- Opt 220** 191 to 233 VAC, 47 to 63 Hz
- Opt 240** 209 to 250 VAC, 47 to 63 Hz
- Opt 0L1** English printed operating manual (full documentation on CD-ROM)
- Opt 0B3** English printed service manual

Accessories

- * **1CM003A** Rack mount flange kit
132.6 mm H (3U) – two flange brackets
- * **1CP002A** Rack mount flange and handle kit
132.6 mm H (3U) – two brackets and front handles
- p/n 1494-0059** Accessory slide kit
- E3663AC** Support rails for Agilent rack cabinets
- * Support rails required

Agilent Models: 6551A, 6552A, 6553A, 6554A, 6555A

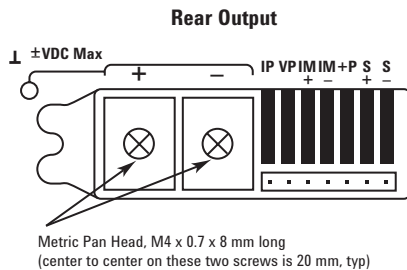

Terminal Screw Size: 6-32 x 5/16 in

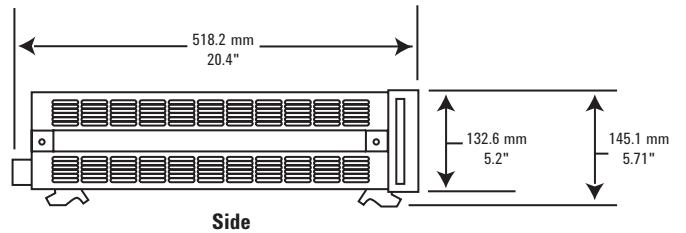
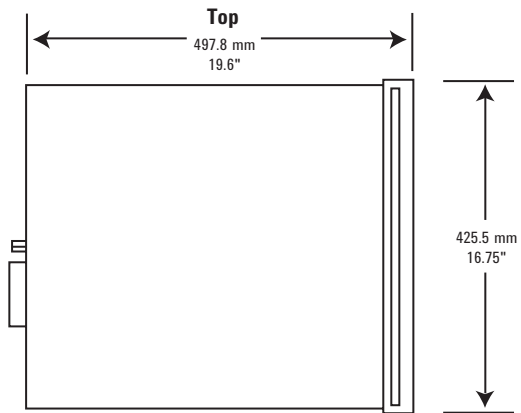
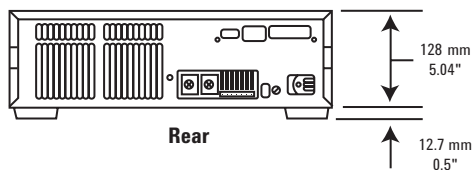

More detailed specifications at www.agilent.com/find/6550

Single-Output 1 & 2 KW GPIB, LAN (LXI core), USB



N7909A, N6950A-N6954A, N6970A-N6974A
N7950A-N7954A, N7970A-N7974A, N6976A,
N6977A, N7976A, N7977A

Accelerate test throughput with industry-leading command processing time
Accurately characterize your DUT's power profile with advanced measurements
Continuously source and sink current for power storage and test applications
Smart triggering: Increased throughput, DUT protection, and reduced complexity
Track power events with a black box recorder
Small high density 3U package
Built-in paralleling capability up to 10 kW

Specifications

(at 0° to 55°C unless otherwise specified)

	N6950A	N6951A	N6952A	N6953A	N6954A
Number of outputs	1	1	1	1	1
GPIB, LAN, USB	Yes	Yes	Yes	Yes	Yes
DC ratings					
Voltage	0 to 9 V	0 to 20 V	0 to 40 V	0 to 60 V	0 to 80 V
Current	0 to 100 A	0 to 50 A	0 to 25 A	0 to 16.7 A	0 to 12.5 A
Current sink 10% rating	-10 A	-5 A	-2.5 A	-1.67 A	-1.25 A
Current sink 100% rating ¹	-100 A	-50 A	-25A	-16.7 A	-12.5 A
Power ²	900 W	1000 W	1000 W	1000 W	1000 W
Output ripple and noise³					
CV rms	1 mV	1 mV	1 mV	1 mV	1 mV
CV peak to peak	9 mV	9 mV	9 mV	9 mV	9 mV
Load regulation					
Voltage	0.5 mV	0.75 mV	1.5 mV	2 mV	2 mV
Current	8 mA	3 mA	1 mA	1 mA	0.8 mA
Voltage programming & measurement accuracy^{4, 5, 6}					
Lead drop ≤1 V max	0.03% + 1.5 mV	3 mV	6 mV	9 mV	12 mV
Lead drop ≤25% of V rating	0.03% + 1.9 mV	4 mV	7.9 mV	12 mV	16 mV
Current programming & measurement accuracy⁴					
	0.1% + 30 mA	15 mA	8 mA	5 mA	4 mA
Transient response⁷					
Recovery time	100 μs	100 μs	100 μs	100 μs	100 μs
Settling band	150 mV	150 mV	100 mV	150 mV	200 mV

Notes:

- ¹ Current sinking up to 100% of rated current requires one power dissipator for 1 kW models, and two power dissipators for 2 kW models. 2 kW models with one power dissipator can sink 50% of their rated current.
- ² Maximum continuous power available is derated at 1% of rating per degree C from 40°C to 55°C
- ³ From 20 Hz to 20 MHz
- ⁴ At 23°C ±5°C after a 30 minute warm-up; measurement NPLC=1; valid for 1 year
- ⁵ With resistance programming enabled, the voltage programming offset component increases by a factor of 2.1
- ⁶ Load lead drop applies to each load lead
- ⁷ Time to recover to within the settling band following a load change from 50% to 100% of full load (10 μs rise time)

Overcome your power test challenges with the Advanced Power System family

With Advanced Power System (APS) 1 kW and 2 kW system power supplies, you get a new level of power supply performance. The Advanced Power System (APS) family was designed with VersaPower architecture to help you overcome your toughest power test challenges by delivering industry-leading specifications and innovative features in an integrated solution for today's advanced ATE power testing needs.

VersaPower architecture delivers the fastest, most accurate, integrated power system

- Accelerate test-system throughput with industry-leading speed
- Capture your DUT's current profile with accurate measurements
- Reduce your ATE development time and cost with highly integrated capabilities

Agilent N6900 Series DC power supplies

Designed for ATE applications where high performance is critical

Agilent N7900 Series dynamic DC power supplies

Designed for ATE applications where high-speed dynamic sourcing and measurement is needed

Single Output: 1 & 2 KW GPIB, LAN (LXI Core), USB (Continued)

Specifications

(at 0° to 55°C unless otherwise specified)

N6950A N6951A N6952A N6953A N6954A

Supplemental Characteristics

(Non-warranted characteristics determined by design that are useful in applying the product)

Two power ranges deliver a large amount of power in a small test-system footprint:

- 1 kW models have a 1U full-rack footprint
- 2 kW models have a 2U full-rack footprint
- Built-in paralleling capability up to 10 kW

Choose the APS model with the voltage and current you need

Both the N6900 Series DC power supplies and the N7900 Series dynamic DC power supplies provide five voltage and current combinations at the 1 kW power range and seven voltage and current combinations at the 2 kW power range.

How the APS Can Help You Overcome Your Power Test Challenges

Accelerate test throughput with industry-leading specifications

Shaving seconds or even milliseconds off a test time can lead to significant savings for high-volume manufacturers, making throughput gains a never-ending quest for test system designers. The APS is a valuable tool for increasing throughput. It provides a number of industry leading specifications and innovative features that can help you achieve significant throughput gains in your testing.

Some examples:

- Industry-leading command processing time (<2 ms)
- Fast up and down programming speeds (up to 500 μs)
- Adjustable measurement times for optimum measurements in minimum time
- Seamless ranging capability for fast current measurements without sacrificing accuracy
- Output lists that allow you to step through timed or triggered voltage or current levels that can also generate triggers for tightly synchronized measurements

	N6950A	N6951A	N6952A	N6953A	N6954A
Programming range					
Voltage	9 mV to 9.18 V	0.02 to 20.4 V	0.04 to 40.8 V	0.06 to 61.2 V	0.08 to 81.6 V
Current (no dissipator)	-10.2 to 102 A	-5.1 to 51 A	-2.55 to 25.5 A	-1.7 to 17 A	-1.275 to 12.75 A
Current (with dissipator)	-102 to 102 A	-51 to 51 A	-25.5 to 25.5 A	-17 to 17 A	-12.75 to 12.75 A
Programming resolution					
Voltage	0.84 mV	1.7 mV	3.5 mV	5 mV	6.7 mV
Current	30 mA	15 mA	8 mA	5 mA	4 mA
Measurement range					
Current	-225 to 225 A	-112.5 to 112.5 A	-56.2 to 56.2 A	-37.6 to 37.6 A	-28.1 to 28.1 A
Resistance programming					
Range	0 to 0.1 Ω	0 to 0.4 Ω	0 to 1.6 Ω	0 to 3.4 Ω	0 to 6.4 Ω
Accuracy ¹	0.12% + 1.6 mΩ*A	0.12% + 3.2 mΩ*A	0.1% + 6.4 mΩ*A	0.1% + 8.8 mΩ*A	0.1% + 12.8 mΩ*A
Resolution	0.8 μΩ	3.4 μΩ	13 μΩ	30 μΩ	54 μΩ
TempCo	0.0068%	0.0070%	0.0070%	0.0070%	0.0070%
Programming & measurement temperature coefficient					
Voltage ²	0.0022% + 30 μV	60 μV	120 μV	180 μV	220 μV
Current ²	0.0057% + 250 μA	0.0058% + 125 μA	0.0058% + 60 μA	0.0058% + 40 μA	0.0058% + 30 μA
Over-voltage protection					
Maximum setting	10.8 V	24 V	48 V	72 V	96 V
Accuracy	0.03% + 1.5 mV	3 mV	6 mV	9 mV	12 mV
Response time ³	<30 μs	<30 μs	<30 μs	<30 μs	<30 μs
Measurement noise (peak)					
Voltage	2 mV	3.5 mV	7 mV	10 mV	14 mV
Current	45 mA	22 mA	10 mA	6 mA	4 mA
Output current noise					
CC rms	15 mA	15 mA	15 mA	15 mA	15 mA
Common mode current					
CC rms	2 mA	1 mA	1 mA	1 mA	1.5 mA
CC peak-to-peak	10 mA	10 mA	10 mA	10 mA	10 mA

Notes:

¹ Resistance programming accuracy varies with output current. For example, for an N7970A unit at 0.1 Ω with a 50 A transient, accuracy is: (0.1 Ω*0.06%) + (1.6 mΩ*A/50 A) = 92 μΩ.

² Per degree C

³ From occurrence of over-voltage to start of shutdown

More detailed specifications at www.agilent.com/find/N6900

Single Output: 1 & 2 KW GPIB, LAN (LXI Core), USB (Continued)

Specifications <small>(at 0° to 55°C unless otherwise specified)</small>	N6950A	N6951A	N6952A	N6953A	N6954A
---	--------	--------	--------	--------	--------

Accurately characterize your DUT's power profile with advanced measurements

The APS provides simultaneous voltage and current measurement capabilities that deliver high accuracy and resolution. Make measurements using two main modes: averaged or digitized. In average mode, the APS delivers high-accuracy DMM-quality voltage and current measurements. The digitizing capability allows you to capture dynamic current or voltage profiles at much higher resolution than an oscilloscope.

- Capture inrush current: APS provides an 18-bit current digitizer with a sample rate up to 200 kS/s, level triggers, and a current measurement range that is 2.25x higher than the max output current range of the power supply.

Supplemental Characteristics	(Non-warranted characteristics determined by design that are useful in applying the product)				
Volt up-programming time⁴					
10% to 90%	3 ms	3 ms	3 ms	3 ms	3 ms
Settling time ⁶	10 ms	10 ms	10 ms	10 ms	10 ms
Volt down-programming time⁵					
90% to 10%	3 ms	3 ms	3 ms	3 ms	3 ms
Settling time ⁶	10 ms	10 ms	10 ms	10 ms	10 ms
Current up-programming time⁷					
10% to 90%	2.5 ms	2.5 ms	2.5 ms	2.5 ms	2.5 ms
Output-on delay time					
Voltage priority	12 ms	12 ms	12 ms	12 ms	12 ms
Current priority	14 ms	14 ms	14 ms	14 ms	14 ms
Line regulation⁸					
Voltage	<10 μV	<10 μV	<10 μV	<10 μV	<10 μV
Current	<10 μA	<10 μA	<10 μA	<10 μA	<10 μA

Notes:

- ⁴ With full resistive load and a voltage transition from 0.1% to 100% of rated output
- ⁵ With no load and a voltage transition from 100% to 0.1% of rated output
- ⁶ From start of voltage change to within 0.1% of final full scale value
- ⁷ With full resistive load and a current transition from 0.1% to 100% of rated output
- ⁸ Line regulation is guaranteed by design

Single Output: 1 & 2 KW GPIB, LAN (LXI Core), USB (Continued)

- Accurately measure power storage and efficiency: In addition to high-accuracy voltage and current measurement capabilities, APS power supplies offer built-in power, peak power, amp-hour, and watt-hour calculations. These measurements help simplify your power efficiency and storage calculations.
- Additional measurement capabilities:
 - Adjustable measurement intervals for both average and digitized measurements
 - External logging capability, which simplifies data logging in ATE software
 - Pre-, post-, and level triggering for pinpointing exactly where and when to measure
- Accurately capture dynamic current profiles: APS has two current measurement ranges that allow it to measure micro-amps to amps. The APS uses seamless ranging technology to transition from one measurement range to the other without discontinuities in the output power or in measurement data. (See figure 1)

Specifications (at 0° to 55°C unless otherwise specified)	N6970A	N6971A	N6972A	N6973A	N6974A
Number of outputs	1	1	1	1	1
GPIB, LAN, USB	Yes	Yes	Yes	Yes	Yes
DC ratings					
Voltage	0 to 9 V	0 to 20 V	0 to 40 V	0 to 60 V	0 to 80 V
Current	0 to 200 A	0 to 100 A	0 to 50 A	0 to 33.3 A	0 to 25 A
Current sink 10% rating	-20 A	-10 A	-5 A	-3.33 A	-2.5 A
Current sink 100% rating ¹	-200 A	-100 A	-50 A	-33.3 A	-25 A
Power ²	1800 W	2000 W	2000 W	2000 W	2000 W
Output ripple and noise³					
CV rms	1 mV	1 mV	1 mV	1 mV	1 mV
CV peak to peak	9 mV	9 mV	9 mV	9 mV	9 mV
Load regulation					
Voltage	0.5 mV	0.75 mV	1.5 mV	2 mV	2 mV
Current	15 mA	6 mA	1.5 mA	1.5 mA	1.5 mA
Voltage programming & measurement accuracy^{4,5,6}					
Lead drop ≤1 V max	0.03% + 1.5 mV	3 mV	6 mV	9 mV	12 mV
Lead drop ≤25% of V rating	0.03% + 1.9 mV	4 mV	7.9 mV	12 mV	16 mV
Current programming & measurement accuracy⁴					
	0.1% + 60 mA	30 mA	15 mA	10 mA	8 mA
Transient response⁷					
Recovery time	100 μs	100 μs	100 μs	100 μs	100 μs
Settling band	150 mV	150 mV	100 mV	150 mV	200 mV

Notes:

- ¹ Current sinking up to 100% of rated current requires one power dissipator for 1 kW models, and two power dissipators for 2 kW models. 2 kW models with one power dissipator can sink 50% of their rated current.
- ² Maximum continuous power available is derated at 1% of rating per degree C from 40°C to 55°C
- ³ From 20 Hz to 20 MHz
- ⁴ At 23°C ±5°C after a 30 minute warm-up; measurement NPLC=1; valid for 1 year
- ⁵ With resistance programming enabled, the voltage programming offset component increases by a factor of 2.1
- ⁶ Load lead drop applies to each load lead
- ⁷ Time to recover to within the settling band following a load change from 50% to 100% of full load (10 μs rise time)

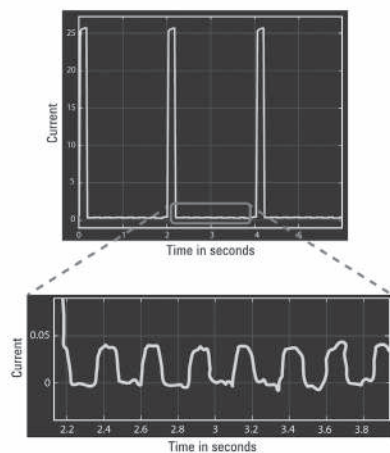

Figure 1. Dynamic current measurement

More detailed specifications at www.agilent.com/find/N6900

Single Output: 1 & 2 KW GPIB, LAN (LXI Core), USB (Continued)

Specifications (at 0° to 55°C unless otherwise specified)	N6970A	N6971A	N6972A	N6973A	N6974A
--	--------	--------	--------	--------	--------

Reduce ATE development time and support costs with integrated features

Smart triggering: Increase throughput, protect your DUT, and reduce test complexity

The APS’s smart triggering system provides trigger capabilities never before seen in a power supply. The APS’s smart triggering can accelerate your test throughput, better protect your DUT, and reduce the complexity of your test system. The smart triggering system includes all the basic triggering functionality you would expect in a system power supply, but it goes well beyond with capabilities such as:

- Level triggering allows you to execute a trigger from five different APS measurement parameters: voltage, current, power, amp-hour, and watt-hour.
- Logical triggering gives you the ability to create logical “and,” “or,” and “not” trigger expressions using various trigger conditions such as digital input pins, level triggers, status bits, and more.
- Triggers can be used to transition through a list of voltage or current levels as well as through the points of a voltage or current waveform.
- Triggers with precision delays can be sent out from the APS after a voltage or current level change/transient. These triggers can be used to signal another instrument in the test system to do something after a voltage or current change.

Supplemental Characteristics	(Non-warranted characteristics determined by design that are useful in applying the product)				
Programming range					
Voltage	0.009 to 9.18 V	0.02 to 20.4 V	0.04 to 40.8 V	0.06 to 61.2 V	0.08 to 81.6 V
Current (no dissipator)	-20.4 to 204 A	-10.2 to 102 A	-5.1 to 51 A	-3.4 to 34 A	-2.55 to 25.5 A
Current (with dissipator)	-204 to 204 A	-102 to 102 A	-51 to 51 A	-34 to 34 A	-25.5 to 25.5 A
Programming resolution					
Voltage	0.84 mV	1.7 mV	3.5 mV	5 mV	6.7 mV
Current	60 mA	30 mA	15 mA	10 mA	8 mA
Measurement range					
Current	-450 to 450 A	-225 to 225 A	-112.5 to 112.5 A	-74.9 to 74.9 A	-56.2 to 56.2 A
Resistance programming					
Range	0 to 0.05 Ω	0 to 0.2 Ω	0 to 0.8 Ω	0 to 1.7 Ω	0 to 3.2 Ω
Accuracy ¹	0.12% + 1.6 mΩ*A	0.12% + 3.2 mΩ*A	0.1% + 6.4 mΩ*A	0.1% + 8.8 mΩ*A	0.1% + 12.8 mΩ*A
Resolution	0.4 μΩ	1.7 μΩ	7 μΩ	15 μΩ	27 μΩ
Temperature coefficient	0.0060%	0.0060%	0.0060%	0.0060%	0.0060%
Programming & measurement temperature coefficient					
Voltage ²	0.0022% +	30 μV	60 μV	120 μV	180 μV
Current ²	0.0048% + 500 μA	0.0049% + 250 μA	0.0049% + 120 μA	0.0049% + 80 μA	0.0049% + 60 μA
Over-voltage protection					
Maximum setting	10.8 V	24 V	48 V	72 V	96 V
Accuracy	0.03% +	1.5 mV	3 mV	6 mV	9 mV
Response time ³	<30 μs	<30 μs	<30 μs	<30 μs	<30 μs
Measurement noise (peak)					
Voltage	2 mV	3.5 mV	7 mV	10 mV	14 mV
Current	75 mA	45 mA	18 mA	12 mA	7 mA
Output current noise					
CC rms	20 mA	20 mA	15 mA	15 mA	15 mA
Common mode current					
CC rms	2 mV	1 mV	1 mV	1 mV	2 mV
CC peak-to-peak	15 mA	10 mA	10 mA	10 mA	10 mA

Notes:
¹ Resistance programming accuracy varies with output current. For example, for an N7970A unit at 0.1 Ω with a 50 A transient, accuracy is: (0.1 Ω*0.06%) + (1.6 mΩ*A/50 A) = 92 μΩ.
² Per degree C
³ From occurrence of over-voltage to start of shutdown

Single Output: 1 & 2 KW GPIB, LAN (LXI Core), USB (Continued)

Specifications <small>(at 0° to 55°C unless otherwise specified)</small>	N6970A	N6971A	N6972A	N6973A	N6974A
---	--------	--------	--------	--------	--------

Continuously source and sink current for power storage test applications

When operated as standalone units, APS power supplies can continuously sink up to 10% of their rated output current for an indefinite time. With the addition of APS N7909A power dissipater units, APS power supplies can continuously sink up to 100% of their rated output current. This means you can sink the power supply's full rated output power for an indefinite time. Note that the two-quadrant sourcing and sinking capability of the DC power supply allows for continuous transitions between sourcing and sinking current without changing the power supply's output characteristics or introducing any disruptive behavior. These capabilities make the APS an ideal solution for continuous source and sink testing needs in power storage applications (see figures 2 and 3).

To compliment the two quadrant operation, all APS power supplies have built-in programmable output resistance capability. This capability allows an APS power supply to simulate the internal resistance of a battery.

Supplemental Characteristics

(Non-warranted characteristics determined by design that are useful in applying the product)

Characteristic	N6970A	N6971A	N6972A	N6973A	N6974A
Volt up-programming time⁴					
10% to 90%	3 ms	3 ms	3 ms	3 ms	3 ms
Settling time ⁶	10 ms	10 ms	10 ms	10 ms	10 ms
Volt down-programming time⁵					
90% to 10%	3 ms	3 ms	3 ms	3 ms	3 ms
Settling time ⁶	10 ms	10 ms	10 ms	10 ms	10 ms
Current up-programming time⁷					
10% to 90%	2.5 ms	2.5 ms	2.5 ms	2.5 ms	2.5 ms
Output-on delay time					
Voltage priority	12 ms	12 ms	12 ms	12 ms	12 ms
Current priority	14 ms	14 ms	14 ms	14 ms	14 ms
Line regulation⁸					
Voltage	< 10 μ V	< 10 μ V	< 10 μ V	< 10 μ V	< 10 μ V
Current	< 10 μ A	< 10 μ A	< 10 μ A	< 10 μ A	< 10 μ A

Notes:

- ⁴ With full resistive load and a voltage transition from 0.1% to 100% of rated output
- ⁵ With no load and a voltage transition from 100% to 0.1% of rated output
- ⁶ From start of voltage change to within 0.1% of final full scale value
- ⁷ With full resistive load and a current transition from 0.1% to 100% of rated output
- ⁸ Line regulation is guaranteed by design

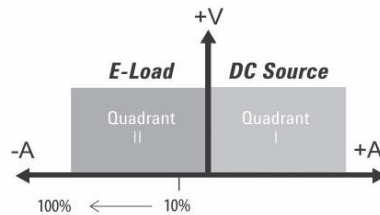

Figure 2. Adding N7909A power dissipater units to an APS supply extends its ability to sink current from 10% to 100% of its rated current

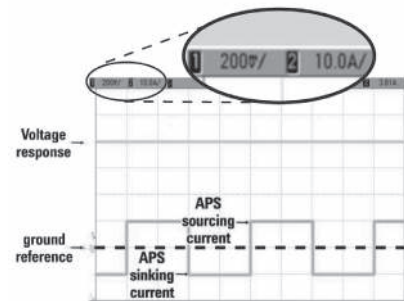

Figure 3. Shows an example of an APS power supply smoothly pulsing back and forth from sinking current at -10 A to sourcing current at 10 A. The voltage level captured at high resolution on the top trace remains constant with no glitches.

Single Output: 1 & 2 KW GPIB, LAN (LXI Core), USB (Continued)

Track power events with a black box recorder

If you are testing expensive prototypes and a power related problem damages or destroys your DUT, you need to figure out what went wrong to ensure it does not happen again. The APS's optional N7908A black box recorder (BBR) overcomes this test challenge by creating a power event record inside the power supply.

Much like an airplane flight data recorder, the APS black box recorder is always recording events. When the power supply is on, it is always running, recording power events and making measurements in non-volatile memory regardless of what the power supply is doing or how it is being used.

Examples of what it records:

- Voltage (min, max, and avg), current (min, max, and avg), and power (min, max, and avg)
- Trigger events
- Status bits
- Front panel and command events
- User defined tags

Specifications (at 0° to 55°C unless otherwise specified)	N7950A	N7951A	N7952A	N7953A	N7954A
Number of outputs	1	1	1	1	1
GPIB, LAN, USB	Yes	Yes	Yes	Yes	Yes
DC ratings					
Voltage source	0 to 9 V	0 to 20 V	0 to 40 V	0 to 60 V	0 to 80 V
Current source	0 to 100 A	0 to 50 A	0 to 25 A	0 to 16.7 A	0 to 12.5 A
Current sink 10% rating	-10 A	-5 A	-2.5 A	-1.67 A	-1.25 A
Current sink 100% rating ¹	-100 A	-50 A	-25 A	-16.7 A	-12.5 A
Power ²	900 W	1000 W	1000 W	1000 W	1000 W
Output ripple and noise³					
CV rms	1 mV	1 mV	1 mV	1 mV	1 mV
CV peak to peak	9 mV	9 mV	9 mV	9 mV	9 mV
Load regulation					
Voltage	0.5 mV	0.75 mV	1.5 mV	2 mV	2 mV
Current	8 mA	3 mA	1 mA	1 mA	0.8 mA
Voltage programming & measurement accuracy^{4,5,6}					
Lead drop ≤1 V max	0.03% + 1 mV	2 mV	4 mV	6 mV	8 mV
Lead drop ≤25% of V rating	0.03% + 1.4 mV	3 mV	5.9 mV	9 mV	12 mV
Current programming & measurement accuracy⁴					
	0.04% + 15 mA	8 mA	4 mA	2.5 mA	2 mA
Current measurement low range accuracy					
	0.05% + 3 mA	1 mA	0.6 mA	0.3 mA	0.25 mA
Transient response⁷					
Recovery time	100 μs	100 μs	100 μs	100 μs	100 μs
Settling band	150 mV	150 mV	100 mV	150 mV	200 mV
Supplemental Characteristics (Non-warranted characteristics determined by design that are useful in applying the product)					
Programming range					
Voltage	0.009 to 9.18 V	0.02 to 20.4 V	0.04 to 40.8 V	0.06 to 61.2 V	0.08 to 81.6 V
Current (no dissipator)	-10.2 to 102 A	-5.1 to 51 A	-2.55 to 25.5 A	-1.7 to 17 A	-1.275 to 12.75 A
Current (with dissipator)	-102 to 102 A	-51 to 51 A	-25.5 to 25.5 A	-17 to 17 A	-12.75 to 12.75 A
Programming resolution					
Voltage	0.21 mV	0.42 mV	0.84 mV	1.25 mV	1.68 mV
Current	1.9 mA	0.95 mA	0.47 mA	0.32 mA	0.24 mA

Notes:

- ¹ Current sinking up to 100% of rated current requires one power dissipator for 1 kW models, and two power dissipators for 2 kW models. 2 kW models with one power dissipator can sink 50% of their rated current.
- ² Maximum continuous power available is derated at 1% of rating per degree C from 40°C to 55°C
- ³ From 20 Hz to 20 MHz
- ⁴ At 23°C ±5°C after a 30 minute warm-up; measurement NPLC=1; valid for 1 year
- ⁵ With resistance programming enabled, the voltage programming offset component increases by a factor of 3.15
- ⁶ Load lead drop applies to each load lead
- ⁷ Time to recover to within the settling band following a load change from 50% to 100% of full load (10 μs rise time)

More detailed specifications at www.agilent.com/find/N7900

Single Output: 1 & 2 KW GPIB, LAN (LXI Core), USB (Continued)

Specifications (at 0° to 55°C unless otherwise specified)	N7950A	N7951A	N7952A	N7953A	N7954A
--	--------	--------	--------	--------	--------

Avoid damage to your DUT with APS protection

When you are testing costly DUTs, integrating power protection measures into the test system is critical. Using instrumentation with built-in protection features provides a huge benefit when DUT protection is required. Here's why:

- Built-in protection features, such as broken sense line detection, reduce the amount of protection hardware needed in the test system reducing complexity and development time.
- With protection features integrated into the instrumentation, the amount of hardware needed for the test system is reduced, which in turn lowers test system support costs.
- With protection measures implemented in hardware rather than test system software, error conditions can be detected and handled much faster, reducing the likelihood of the DUT sustaining major damage.

Supplemental Characteristics		(Non-warranted characteristics determined by design that are useful in applying the product)				
Current measurement range						
High range		-225 to 225 A	-112.5 to 112.5 A	-56.2 to 56.2 A	-37.6 to 37.6 A	-28.1 to 28.1 A
Low range		-11 to 11 A	-5.5 to 5.5 A	-2.75 to 2.75 A	-1.84 to 1.84 A	-1.37 to 1.37 A
Resistance programming						
Range		0 to 0.1 Ω	0 to 0.4 Ω	0 to 1.6 Ω	0 to 3.4 Ω	0 to 6.4 Ω
Accuracy ¹	0.06% +	1.6 mΩ*A	3.2 mΩ*A	6.4 mΩ*A	8.8 mΩ*A	12.8 mΩ*A
Resolution		0.8 μΩ	3.4 μΩ	13 μΩ	30 μΩ	54 μΩ
Temperature coefficient		0.0046%	0.0049%	0.0054%	0.0050%	0.0049%
Programming & measurement temperature coefficient²						
Voltage	0.0022% +	30 μV	60 μV	120 μV	180 μV	220 μV
Current		0.0035% + 250 μA	0.0035% + 125 μA	0.0042% + 60 μA	0.0037% + 40 μA	0.0036% + 30 μA
Current Measurement low range		0.0042% + 80 μA	0.0045% + 40 μA	0.0050% + 20 μA	0.0046% + 12 μA	0.0045% + 9 μA
Over-voltage protection						
Maximum setting		10.8 V	24 V	48 V	72 V	96 V
Accuracy	0.03% +	1 mV	2 mV	4 mV	6 mV	8 mV
Response time ³		<30 μs	<30 μs	<30 μs	<30 μs	<30 μs
Measurement noise (peak)						
Voltage		2 mV	3.5 mV	7 mV	10 mV	14 mV
Current		45 mA	22 mA	10 mA	6 mA	4 mA
Current - low range		30 mA	17 mA	7 mA	4 mA	2 mA
Output current noise						
CC rms		15 mA	15 mA	15 mA	15 mA	15 mA
Common mode current						
CC rms		2 mA	1 mA	1 mA	1 mA	1.5 mA
CC peak-to-peak		10 mA	10 mA	10 mA	10 mA	10 mA
Voltage up-programming time⁴						
10% to 90%		0.5 ms	0.5 ms	0.5 ms	0.5 ms	0.5 ms
Settling time ⁶		1 ms	1 ms	1 ms	1 ms	1 ms
Voltage down-programming time⁵						
90% to 10%		0.35 ms	0.35 ms	0.35 ms	0.35 ms	0.35 ms
Settling time ⁶		0.8 ms	0.8 ms	0.8 ms	0.8 ms	0.8 ms
Current up-programming time⁷						
10% to 90%		2.5 ms	2.5 ms	2.5 ms	2.5 ms	2.5 ms

Notes:

- ¹ Resistance programming accuracy varies with output current. For example, for an N7970A unit at 0.1 Ω with a 50 A transient, accuracy is: (0.1 Ω*0.06%) + (1.6 mΩ*A/50 A) = 92 μΩ.
- ² Per degree C
- ³ From occurrence of over-voltage to start of shutdown
- ⁴ With full resistive load and a voltage transition from 0.1% to 100% of rated output
- ⁵ With no load and a voltage transition from 100% to 0.1% of rated output
- ⁶ From start of voltage change to within 0.1% of final full scale value
- ⁷ With full resistive load and a current transition from 0.1% to 100% of rated output

More detailed specifications at www.agilent.com/find/N7900

Single Output: 1 & 2 KW GPIB, LAN (LXI Core), USB (Continued)

Specifications <small>(at 0° to 55°C unless otherwise specified)</small>	N7950A	N7951A	N7952A	N7953A	N7954A
---	--------	--------	--------	--------	--------

Supplemental Characteristics (Non-warranted characteristics determined by design that are useful in applying the product)

Output-on delay time					
Voltage priority	12 ms	12 ms	12 ms	12 ms	12 ms
Voltage priority (with relay on)	38 ms	38 ms	38 ms	38 ms	38 ms
Current priority	14 ms	14 ms	14 ms	14 ms	14 ms
Current priority (with relay on)	46 ms	46 ms	46 ms	46 ms	46 ms
Line regulation ⁸					
Voltage	<10 μ V	<10 μ V	<10 μ V	<10 μ V	<10 μ V
Current	<10 μ A	<10 μ A	<10 μ A	<10 μ A	<10 μ A
Small signal bandwidth					
Voltage programming ⁹	DC to 1 kHz (-1dB); DC to 2 kHz (-3dB)				
Current programming ¹⁰	DC to 70 Hz (-1dB); DC to 120 Hz (-3dB)				
Voltage measurement	DC to 14 kHz (-1dB); DC to 25 kHz (-3dB)				
Current measurement	DC to 14 kHz (-1dB); DC to 25 kHz (-3dB)				

- Notes:**
- ⁸ Line regulation is guaranteed by design
 - ⁹ With High Bandwidth setting, resistive load condition
 - ¹⁰ With resistive load condition

The APS power supplies feature advanced and fast protection capabilities fully integrated including:

- Fast CC/CV mode crossover as well as user-settable voltage and current priority modes to reduce unwanted voltage or current overshoots
- Smart triggering
- Over- and under-voltage and current protection
- Fast reaction to error conditions
- Output disconnect relays
- User-configurable watchdog timer
- Broken and shorted sense line detection

Generate voltage and current transients

DUTs that are operated in rugged environments, such as automotive electronics and avionics, can often experience transient behavior from the power source, such as voltage dropouts or surges. To ensure your DUT can stand up to these real-world transients, you must simulate worst-case power transient conditions in the test process. The APS power supplies provide three different functionalities for simulating either voltage or current transients for testing:

Step: One-time event that steps the output voltage or current up or down in response to a triggered event.

Arbitrary waveforms: An arbitrary waveform generator (arb) allows you to generate complex user-defined voltage or current waveforms of up to 65,535 data points.

List: A list can consist of up to 512 steps. Each step in the list can have a unique dwell time associated with it, which specifies the time in seconds that the list will remain at that step before moving on to the next step. Lists can also be trigger-paced, in which case the list advances one step for each trigger received. To demonstrate the APS’s arb capability an example “interrupt” pulse was generated with the N7951A into a resistive load.

The captured interrupt pulse (figure 4) goes from 20 V to 2 V for 10 ms and then returns to 20 V. The measured fall time of the pulse (figure 5) was less than 200 μ s.

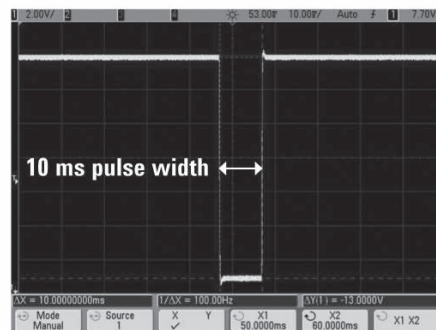

Figure 4. Voltage interrupt pulse

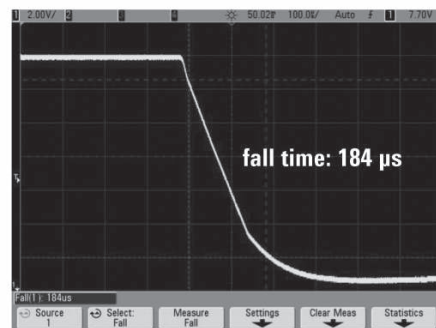

Figure 5. Pulse fall time of < 200 μ s

Single Output: 1 & 2 KW GPIB, LAN (LXI Core), USB (Continued)

Properly powering on and off your DUT with the APS

If you work with DUTs that have multiple power supply inputs, such as satellite payloads, you often need to properly sequence on or off each power supply at strict repeatable times to prevent current surges and latchup conditions. In addition to sequencing on or off each supply, you may need to set the ramp rate of each supply at turn-on or turn-off to a particular rate. These requirements add significant complexity to an ATE test system, both in hardware and software. The APS power supplies can help you overcome this test challenge by providing built-in sequencing capability across APS mainframes or with Agilent's popular N6700 family of modular system power supplies. Also, the APS power supplies provide adjustable slew rate control at turn-on or turn-off. These built-in capabilities provide a clean low-complexity way to properly power-on or off your DUT during test.

Add power flexibility to your test system by paralleling multiple APS supplies

Paralleling multiple power supplies together is a great way to add power flexibility to your test system. The down side of paralleling power supplies together is typically you cannot get all the supplies to operate in the desired constant voltage (CV) or constant current (CC) mode. For instance, when trying to operate in CV mode with two parallel supplies, one will typically source the bulk of the current and operate in CC mode and the other supply will source only a fraction of the current and operate in CV mode. This condition can highly degrade certain power supply performance specifications such as transient response.

Specifications (at 0° to 55°C unless otherwise specified)	N7970A	N7971A	N7972A	N7973A	N7974A
Number of outputs	1	1	1	1	1
GPIB, LAN, USB	Yes	Yes	Yes	Yes	Yes
DC ratings					
Voltage source	0 to 9 V	0 to 20 V	0 to 40 V	0 to 60 V	0 to 80 V
Current source	0 to 200 A	0 to 100 A	0 to 50 A	0 to 33.3 A	0 to 25 A
Current sink 10% rating	-20 A	-10 A	-5 A	-3.33 A	-2.5 A
Current sink 100% rating ¹	-200 A	-100 A	-50 A	-33.3 A	-25 A
Power ²	1800 W	2000 W	2000 W	2000 W	2000 W
Output ripple and noise³					
CV rms	1 mV	1 mV	1 mV	1 mV	1 mV
CV peak to peak	9 mV	9 mV	9 mV	9 mV	9 mV
Load regulation					
Voltage	0.5 mV	0.75 mV	1.5 mV	2 mV	2 mV
Current	15 mA	6 mA	1.5 mA	1.5 mA	1.5 mA
Voltage programming & measurement accuracy^{4, 5, 6}					
Lead drop ≤1 V max	0.03% + 1 mV	2 mV	4 mV	6 mV	8 mV
Lead drop ≤25% of V rating	0.03% + 1.4 mV	3 mV	5.9 mV	9 mV	12 mV
Current programming & measurement accuracy⁴					
	0.04% + 30 mA	15 mA	8 mA	5 mA	4 mA
Current measurement low range accuracy					
	0.05% + 6 mA	2 mA	1.2 mA	0.6 mA	0.5 mA
Transient response⁷					
Recovery time	100 μs	100 μs	100 μs	100 μs	100 μs
Settling band	150 mV	150 mV	100 mV	150 mV	200 mV
Supplemental Characteristics	(Non-warranted characteristics determined by design that are useful in applying the product)				
Programming range					
Voltage	0.009 to 9.18 V	0.02 to 20.4 V	0.04 to 40.8 V	0.06 to 61.2 V	0.08 to 81.6 V
Current (no dissipator)	-20.4 to 204 A	-10.2 to 102 A	-5.1 to 51 A	-3.4 to 34 A	-2.55 to 25.5 A
Current (with dissipator)	-204 to 204 A	-102 to 102 A	-51 to 51 A	-34 to 34 A	-25.5 to 25.5 A
Programming resolution					
Voltage	0.21 mV	0.42 mV	0.84 mV	1.25 mV	1.68 mV
Current	3.8 mA	1.9 mA	0.95 mA	0.64 mA	0.48 mA

Notes:

- ¹ Current sinking up to 100% of rated current requires one power dissipator for 1 kW models, and two power dissipators for 2 kW models. 2 kW models with one power dissipator can sink 50% of their rated current.
- ² Maximum continuous power available is derated at 1% of rating per degree C from 40°C to 55°C
- ³ From 20 Hz to 20 MHz
- ⁴ At 23°C ±5°C after a 30 minute warm-up; measurement NPLC=1; valid for 1 year
- ⁵ With resistance programming enabled, the voltage programming offset component increases by a factor of 3.15
- ⁶ Load lead drop applies to each load lead
- ⁷ Time to recover to within the settling band following a load change from 50% to 100% of full load (10 μs rise time)

More detailed specifications at www.agilent.com/find/N7900

Single Output: 1 & 2 KW GPIB, LAN (LXI Core), USB (Continued)

Specifications (at 0° to 55°C unless otherwise specified)	N7970A	N7971A	N7972A	N7973A	N7974A
--	--------	--------	--------	--------	--------

With the APS you do not have to worry about this since it has built-in paralleling capability that ensures each supply equally shares the load current so they all remain in the desired mode, whether it is CV or CC. Note that paralleling works whether the APS power supplies are sourcing or sinking current from the DUT.

To take advantage of the APS paralleling capability, you need only a simple three-wire connection in the rear of the supplies in the parallel configuration (see figure 6). With this capability, you can parallel up to five APS power supplies (recommended), which provides a max power of 10 kW.

Supplemental Characteristics		(Non-warranted characteristics determined by design that are useful in applying the product)				
Current measurement range						
High range		-450 to 450 A	-225 to 225 A	-112.5 to 112.5 A	-74.9 to 74.9 A	-56.2 to 56.2 A
Low range		-22 to 22 A	-11 to 11 A	-5.5 to 5.5 A	-3.67 to 3.67 A	-2.75 to 2.75 A
Resistance programming						
Range		0 to 0.05 Ω	0 to 0.2 Ω	0 to 0.8 Ω	0 to 1.7 Ω	0 to 3.2 Ω
Accuracy ¹	0.06% +	1.6 mΩ*A	3.2 mΩ*A	6.4 mΩ*A	8.8 mΩ*A	12.8 mΩ*A
Resolution		0.4 μΩ	1.7 μΩ	7 μΩ	15 μΩ	27 μΩ
Temperature coefficient		0.0043%	0.0045%	0.0049%	0.0046%	0.0045%
Programming & measurement temperature coefficient						
Voltage ²	0.0022% +	30 μV	60 μV	120 μV	180 μV	220 μV
Current ²		0.0029% + 500 μA	0.0031% + 250 μA	0.0035% + 120 μA	0.0032% + 80 μA	0.0032% + 60 μA
Current measurement low range temperature coefficient²						
		0.0040% + 160 μA	0.0041% + 80 μA	0.0045% + 40 μA	0.0042% + 24 μA	0.0041% + 18 μA
Over-voltage protection						
Maximum setting		10.8 V	24 V	48 V	72 V	96 V
Accuracy	0.03% +	1 mV	2 mV	4 mV	6 mV	8 mV
Response time ³		<30 μs	<30 μs	<30 μs	<30 μs	<30 μs
Measurement noise (peak)						
Voltage		2 mV	3.5 mV	7 mV	10 mV	14 mV
Current		75 mA	45 mA	18 mA	12 mA	7 mA
Current - low range		50 mA	30 mA	12 mA	6 mA	3 mA
Output current noise						
CC rms		20 mA	20 mA	15 mA	15 mA	15 mA
Common mode current						
CC rms		2 mV	1 mV	1 mV	1 mV	2 mV
CC peak-to-peak		15 mA	10 mA	10 mA	10 mA	10 mA

Notes:

- ¹ Resistance programming accuracy varies with output current. For example, for an N7970A unit at 0.1 Ω with a 50 A transient, accuracy is: (0.1 Ω*0.06%) + (1.6 mΩ*A/50 A) = 92 μΩ.
- ² Per degree C
- ³ From occurrence of over-voltage to start of shutdown



Figure 6. An APS supply's three-wire connection for paralleling multiple supplies

More detailed specifications at www.agilent.com/find/N7900

Single Output: 1 & 2 KW GPIB, LAN (LXI Core), USB (Continued)

Specifications <small>(at 0° to 55°C unless otherwise specified)</small>	N7970A	N7971A	N7972A	N7973A	N7974A
---	--------	--------	--------	--------	--------

APS Hardware Accessories and Software

APS N7909A power dissipater unit

The optional N7909A power dissipater unit adds current sinking or two-quadrant operation to any N6900 or N7900 power supply. Each N7909A provides up to 1 kW of current sinking capability to an APS power supply, so you will need two N7909As to achieve full two-quadrant operation of a 2 kW APS supply. You can use a single N7909A with a 2 kW APS power supply to achieve 50% current sinking capability. The N7909A form factor is 1U and full rack width. N7909A connects to an APS power supply via a two-wire power connection and a communication connection to provide continuous two quadrant operation. The connections are located on the rear panel of both the N7909A and the supply, as shown in Figure 7. The N7909A does not operate as a standalone instrument. It only works with an APS power supply. Additional information on the APS's 2-quadrant operation:

- The APS provides programmable +/- current waveform capability to fully utilize the two-quadrant operation
- The APS provides +/- current limit settings to ensure your device is operated in its allowable range
- By default, the APS's current sink capability will perform down programming for pulling down voltage levels when it is connected to loads with stored energy, for instance loads with a large amount of parallel capacitance at their input.
- All these capabilities are also available when you use a standalone APS power supply's 10%

Supplemental Characteristics

(Non-warranted characteristics determined by design that are useful in applying the product)

Supplemental Characteristics	N7970A	N7971A	N7972A	N7973A	N7974A
Voltage up-programming time⁴					
10% to 90%	0.5 ms	0.5 ms	0.5 ms	0.5 ms	0.5 ms
Settling time ⁶	1 ms	1 ms	1 ms	1 ms	1 ms
Voltage down-programming time⁵					
90% to 10%	0.35 ms	0.35 ms	0.35 ms	0.35 ms	0.35 ms
Settling time ⁶	0.8 ms	0.8 ms	0.8 ms	0.8 ms	0.8 ms
Current up-programming time⁷					
10% to 90%	2.5 ms	2.5 ms	2.5 ms	2.5 ms	2.5 ms
Output-on delay time					
Voltage priority	12 ms	12 ms	12 ms	12 ms	12 ms
Voltage priority (with relay on)	38 ms	38 ms	38 ms	38 ms	38 ms
Current priority	14 ms	14 ms	14 ms	14 ms	14 ms
Current priority (with relay on)	46 ms	46 ms	46 ms	46 ms	46 ms
Line regulation⁸					
Voltage	<10 µV	<10 µV	<10 µV	<10 µV	<10 µV
Current	<10 µA	<10 µA	<10 µA	<10 µA	<10 µA
Small signal bandwidth					
Voltage programming ⁹	DC to 1 kHz (-1dB); DC to 2 kHz (-3dB)				
Current programming ¹⁰	DC to 70 Hz (-1dB); DC to 120 Hz (-3dB)				
Voltage measurement	DC to 14 kHz (-1dB); DC to 25 kHz (-3dB)				
Current measurement	DC to 14 kHz (-1dB); DC to 25 kHz (-3dB)				

Notes:

- ⁴ With full resistive load and a voltage transition from 0.1% to 100% of rated output
- ⁵ With no load and a voltage transition from 100% to 0.1% of rated output
- ⁶ From start of voltage change to within 0.1% of final full scale value
- ⁷ With full resistive load and a current transition from 0.1% to 100% of rated output
- ⁸ Line regulation is guaranteed by design
- ⁹ With High Bandwidth setting, resistive load condition
- ¹⁰ With resistive load condition

rated output current sinking capability without the N7909A power dissipater unit.

Although the APS's two-quadrant operation gives it much of the same functionality as a DC electronic load, it cannot simulate current transients as fast as an electronic load. For instance, the APS can simulate full range +/- current transients at ~5 ms, whereas a high performance electronic load can achieve current transients < 1 ms.



APS N7909A power dissipater unit

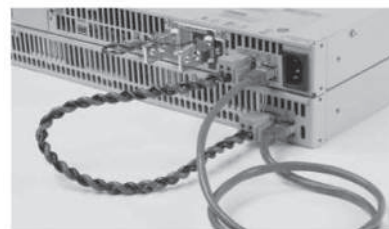

Figure 7. N7909A power dissipater unit rear connections to a 1 kW APS power supply

Single Output: 1 & 2 KW GPIB, LAN (LXI Core), USB (Continued)

Specifications (at 0° to 55°C unless otherwise specified)	N6976A	N6977A	N7976A	N7977A
Number of outputs	1	1	1	1
GPIB, LAN, USB	Yes	Yes	Yes	Yes
DC ratings				
Voltage source	0 to 120 V	0 to 160 V	0 to 120 V	0 to 160 V
Current source	0 to 16.7 A	0 to 12.5 A	0 to 16.7 A	0 to 12.5 A
Current sink 10% rating	-1.67 A	-1.25 A	-1.67 A	-1.25 A
Current sink 100% rating ¹	-16.7 A	-12.5 A	-16.7 A	-12.5 A
Power ²	2000 W	2000 W	2000 W	2000 W
Output ripple and noise³				
CV rms	2 mV	3 mV	2 mV	3 mV
CV peak to peak	30 mV	30 mV	30 mV	30 mV
Load regulation				
Voltage	4 mV	4 mV	4 mV	4 mV
Current	1 mA	0.8 mA	1 mA	0.8 mA
Voltage programming & measurement accuracy^{4, 5, 6}				
Lead drop ≤1 V max 0.03% +	17 mV	24 mV	11 mV	14 mV
Lead drop ≤25% of V rating 0.03% +	23 mV	32 mV	17 mV	22 mV
Current programming & measurement accuracy⁴				
	0.1% + 5 mA	0.1% + 4 mA	0.04% + 2.5 mA	0.04% + 2 mA
Current measurement low range accuracy				
	N/A	N/A	0.05% + 0.4 mA	0.05% + 0.25 mA
Transient response⁷				
Recovery time	100 μs	100 μs	100 μs	100 μs
Settling band	300 mV	400 mV	300 mV	400 mV

APS N7907A rack mount kit

The N7907A rack mount kit can be used for all N6900 and N7900 power supplies, regardless if they are 1 kW or 2 kW form factors. It can also be used for mounting the N7909A. N7907A APS rack mount kit is needed for every APS power supply or N7909A dissipater that you would like to mount. The N7907A is intended for use in a 19-inch EIA rack cabinet. APS power supplies and power dissipater units can be mounted directly above or below each other without any worry of heat problems. For installation instructions refer to the APS user manual.

APS N7908A black box recorder

Much like a flight data recorder, the N7908A black box recorder (BBR) runs continually in the background, independent of what the power supply is doing. When the power supply is on, the BBR is recording power events and storing measurements in non-volatile memory. The BBR can be set for either a 24-hour record or a 10-day record period. In the 24-hour mode, measurements are made at a rate of 100 per second, and in the 10-day mode they are made at a rate of 10 per second. The BBR data can be accessed via the free APS power assistant software (see Figure 8). The BBR is a user-installable hardware option, and it works in all APS N6900 and N7900 power supplies. You can purchase the N7908A BBR with an APS power supply or buy it later and install it in your existing APS power supply. The BBR hardware board plugs into the bottom of an APS power supply, as shown in Figure 9.

Notes:

- Two power dissipators required to sink up to 100% of rated current; one power dissipator sinks up to 50% of rated current.
- Maximum continuous power available is derated at 1% of rating per degree C from 40°C to 55°C
- From 20 Hz to 20 MHz
- At 23°C ±5°C after a 30 minute warm-up; measurement NPLC=1; valid for 1 year
- With resistance programming enabled, the voltage programming offset component increases by a factor of 2.1
- Load lead drop applies to each load lead
- Time to recover to within the settling band following a load change from 50% to 100% of full load (10 μs rise time)

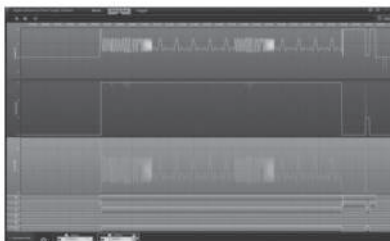

Figure 8. Black box recorder data displayed within the N7906A Power Assistant software



Figure 9. Installing the N7908A BBR hardware option on an APS power supply

More detailed specifications at www.agilent.com/find/N6900
www.agilent.com/find/N7900

Single Output: 1 & 2 KW GPIB, LAN (LXI Core), USB (Continued)

Specifications <small>(at 0° to 55°C unless otherwise specified)</small>	N6976A	N6977A	N7976A	N7977A
---	--------	--------	--------	--------

N7906A power assistant software

The APS N7906A power assistant software is a free application that works with the APS power supplies. The power assistant software provides three main capabilities for working with the APS power supplies:

- Control an APS power supply using the Power assistant software's intuitive graphical user interface
- Retrieve and view data from the optional APS power supply black box recorder (see Figure 9)
- Perform trigger routing and configure logical trigger expressions (see Figure 10)

The power assistant software is available for download at: www.agilent.com/find/powerassistant. For more information on the APS power assistant software, refer to the APS user manual at: www.agilent.com/find/APS-doc.

Supplemental Characteristics

(Non-warranted characteristics determined by design that are useful in applying the product)

Programming range				
Voltage	0.12 to 122.4 V	0.16 to 163.2 V	0.12 to 122.4 V	0.16 to 163.2 V
Current (no dissipator)	-1.7 to 17 A	-1.275 to 12.75 A	-1.7 to 17 A	-1.275 to 12.75 A
Current (with dissipator)	-17 to 17 A	-12.75 to 12.75 A	-17 to 17 A	-12.75 to 12.75 A
Programming resolution				
Voltage	16.9 mV	22.5 mV	2.5 mV	3.6 mV
Current	5 mA	3.8 mA	0.32 mA	0.24 mA
Current measurement range				
High range	-37.6 to 37.6 A	-28.1 to 28.1 A	-37.6 to 37.6 A	-28.1 to 28.1 A
Low range	N/A	N/A	-1.84 to 1.84 A	-1.37 to 1.37 A
Resistance programming				
Range	0 to 6.8 Ω	0 to 12.8 Ω	0 to 6.8 Ω	0 to 12.8 Ω
Accuracy ¹	0.1% + 17.7 mΩ*A	0.1% + 25.6 mΩ*A	0.06% + 17.7 mΩ*A	0.06% + 25.6 mΩ*A
Resolution	60 μΩ	108 μΩ	60 μΩ	108 μΩ
Temperature coefficient	0.0060%	0.0060%	0.0050%	0.0046%
Programming & measurement temperature coefficient				
Voltage ²	0.0022% + 430 μV	570 μV	430 μV	530 μV
Current ²	0.0065% + 12 μA	0.0058% + 30 μA	0.0036% + 40 μA	0.0036% + 30 μA
Current measurement low range temperature coefficient ²				
	N/A	N/A	0.0046% + 12 μA	0.0045% + 9 μA

Notes:

¹ Resistance programming accuracy varies with output current. For example, for an N7970A unit at 0.1 Ω with a 50 A transient, accuracy is: (0.1 Ω*0.06%) + (1.6 mΩ*A/50 A) = 92 μΩ.

² Per degree C

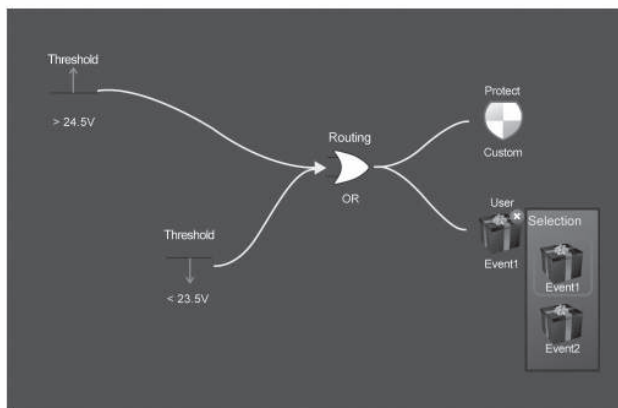

Figure 10. Configuring a trigger expression with the N7906A Power Assistant software

More detailed specifications at www.agilent.com/find/N6900
www.agilent.com/find/N7900

Single Output: 1 & 2 KW GPIB, LAN (LXI Core), USB (Continued)

Specifications

(at 0° to 55°C unless otherwise specified)

N6976A

N6977A

N7976A

N7977A

APS General Information

APS N6900 Series and N7900 Series power supply power requirements

Connect the power cord that was supplied with your unit to the AC mains connector on the rear of the unit. Note that these cords are standard and are specially rated to handle the power needs of the APS supply they are shipped with. The AC input on the back of your unit is a universal AC input. It accepts nominal line voltages in the range of 100 VAC to 240 VAC. The frequency can be 50 Hz, 60 Hz, or 400 Hz. AC mains rated below 180 VAC cannot supply enough current to power either the 1 kW or the 2 kW N6900 and N7900 models to their full rated output power. In such cases, when a 1 kW or 2 kW APS power supply is connected to below 180 VAC AC mains, the power supply will still operate normally, but its maximum output power will be limited to 700 W. In this condition, if the power supply exceeds 700 W of output power the instrument turns off the output and sets the CP+ status bit.

APS power supply connectivity

All APS power supplies come standard with GPIB (IEEE-488), LAN (LXI Core), and USB remote programming interfaces. GPIB and LAN parameters can be set via the front panel. The APS is LXI Core 2011 compliant and includes a built-in Web interface. This means you can control the APS remotely using a Web browser and a LAN connection.

Supplemental Characteristics

(Non-warranted characteristics determined by design that are useful in applying the product)

	N6976A	N6977A	N7976A	N7977A
Over-voltage protection				
Maximum setting	144 V	192 V	144 V	192 V
Accuracy	0.03% +	17 mV	24 mV	11 mV
Response time ³	<30 μs	<30 μs	<30 μs	<30 μs
Measurement noise (peak)				
Voltage	18 mV	23 mV	18 mV	23 mV
Current	6 mA	4 mA	6 mA	4 mA
Current (low range)	N/A	N/A	4 mA	2 mA
Output current noise				
CC rms	15 mA	15 mA	15 mA	15 mA
Common mode current				
CC rms	2 mA	2 mA	2 mA	2 mA
CC peak to peak	10 mA	10 mA	10 mA	10 mA
Volt up-programming time⁴				
10% to 90%	3 ms	3 ms	0.5 ms	0.5 ms
Settling time ⁶	10 ms	10 ms	1 ms	1 ms
Volt down-programming time⁵				
90% to 10%	3 ms	3 ms	0.35 ms	0.35 ms
Settling time ⁶	10 ms	10 ms	0.8 ms	0.8 ms
Current up-programming time⁷				
10% to 90%	2.5 ms	2.5 ms	2.5 ms	2.5 ms
Output-on delay time				
Voltage priority	12 ms	12 ms	12 ms	12 ms
Voltage priority (with relay on)	N/A	N/A	38 ms	38 ms
Current priority	14 ms	14 ms	14 ms	14 ms
Current priority (with relay on)	N/A	N/A	46 ms	46 ms
Line regulation⁸				
Voltage	<10 μV	<10 μV	<10 μV	<10 μV
Current	<10 μA	<10 μA	<10 μA	<10 μA
Small signal bandwidth			N7976A & N7977A	
Voltage programming ⁹	N/A	N/A	DC to 1 kHz (-1dB); DC to 2 kHz (-3dB)	
Current programming ¹⁰	N/A	N/A	DC to 70 Hz (-1dB); DC to 120 Hz (-3dB)	
Voltage measurement	N/A	N/A	DC to 14 kHz (-1dB); DC to 25 kHz (-3dB)	
Current measurement	N/A	N/A	DC to 14 kHz (-1dB); DC to 25 kHz (-3dB)	

Notes:

³ From occurrence of over-voltage to start of shutdown

⁴ With full resistive load and a voltage transition from 0.1% to 100% of rated output

⁵ With no load and a voltage transition from 100% to 0.1% of rated output

⁶ From start of voltage change to within 0.1% of final full scale value

⁷ With full resistive load and a current transition from 0.1% to 100% of rated output

⁸ Line regulation is guaranteed by design

⁹ With High Bandwidth setting, resistive load condition

¹⁰ With resistive load condition

More detailed specifications at www.agilent.com/find/N6900
www.agilent.com/find/N7900

Single Output: 1 & 2 KW GPIB, LAN (LXI Core), USB

APS weight and dimensions

Weight and dimensions are the same for the N6900 Series and N7900 Series APS power supplies:

1 kW power supplies

Weight: 24 lbs. (10.9 kg.)

Size: L 22.39 in / 568.7 mm, W 16.81 in / 426.9 mm, H 1.75 in / 44.45 mm

2 kW power supplies

Weight: 34 lbs. (15.5 kg.)

Size: L 24.928 in / 633.2 mm, W 16.81 in / 426.9 mm, H 3.468 in / 88.1 mm

Power dissipater unit

Weight: 18 lbs. (8.2 kg.)

Size: L 19.81 in / 503.3 mm, W 16.81 in / 426.9 mm, H 1.75 in / 44.45 mm

Warranty: Three years

Ordering information

Accessories and options

N7909A 1 kW power dissipator. 1 unit is required for 1 kW power supplies to sink the rated output power; 2 units are required for 2 kW power supplies to sink the rated output power.

N7908A Option 057 Black Box Recorder board. Installs in a slot on the bottom of unit. When installed, appears as Option 057 in the "About" screen and must be check-marked on the unit label.

N7907A Rack Ear and Slide Accessory Kit - everything needed for mounting 1 kW models, 2 kW models, and the power dissipator in 19-inch EIA cabinets.

N6700-60012 1U Rack ears only - for 1 kW models and the power dissipator (1.75 in. high)

5063-9212 2U Rack ears only - for 2 kW models (3.5 in. high)

5063-9219 2U Rack ears with handles - for 2 kW models (3.5 in. high)

5003-1128 Rack slides only - for mounting 1 kW models, 2 kW models, and the power dissipator in 19-inch EIA cabinets.

E664AC Rails only - for mounting 2 kW models in 19 inch EIA cabinets. Because of required airflow, you cannot use rails for rack mounting 1 kW models or the power dissipator.

Option UK6 Commercial calibration with test results data.

Option 760 Disconnect relays with polarity reverse. When installed, appears as option 760 in the "About" screen and on the unit label. Included on most N7900 models - see previous table.

Option 761 Disconnect relays - no polarity reverse. When installed, appears as option 761 in the "About" screen and on the unit label. Included on N7950A and N7970A models - see previous table.

Opt 1A7 ISO17025 calibration certificate

Opt UK6 Commercial calibration with test results data

Opt 900 Power cord - United Kingdom

Opt 901 Power cord - Australia and New Zealand

Opt 902 Power cord - Continental Europe

Opt 903 Power cord - United States and Canada - 120 V

Opt 904 Power cord - United States and Canada - 240 V

Opt 906 Power cord - Switzerland

Opt 912 Power cord - Denmark

Opt 917 Power cord - India

Opt 918 Power cord - Japan - 100 V

Opt 919 Power cord - Israel

Opt 920 Power cord - Argentina

Opt 921 Power cord - Chile

Opt 922 Power cord - China - 250 V

Opt 923 Power cord - South Africa

Opt 927 Power cord - Thailand and Philippines

Opt 929 Power cord - Japan - 250 V

Opt 930 Power cord - Brazil

Opt 931 Power cord - Taiwan

Opt 932 Power cord - Cambodia

Opt PLG Continental European power cord - only for EU DISTR W MULT PWR CORD standards



6671A - 6675A

Single-Output 2000 W GPIB

- Fast, low-noise outputs
- Analog control of output voltage and current
- Fan-speed control to minimize acoustic noise
- Built-in measurements and advanced programmable features
- Protection features to ensure DUT safety

This series of 2000 watt DC power supplies has the exceptional, proven reliability that test system engineers look for. It also has the unusual combination of high efficiency and low noise operation.

Programming of the DC output and the extensive protection features can be done either from the front panel or using industry standard SCPI commands, via the GPIB. Using the serial link, up to 16 power supplies can be connected through one GPIB address. Test system integration can be further simplified by using the *VXIPlug&Play* drivers. The output voltage and current can also be controlled with analog signals. This is helpful for certain types of noisy environments, and also immediate reactions to process changes.

Lab-bench use is enhanced by the fan-speed control, which minimizes acoustic noise. The extremely low ripple and noise helps the built-in measurement system make extremely accurate current and voltage measurements.

Specifications

(at 0° to 55°C unless otherwise specified)

	6671A	6672A	6673A	6674A	6675A
Number of outputs	1	1	1	1	1
GPIB	Yes	Yes	Yes	Yes	Yes
Output ratings					
Output voltage	0 to 8 V	0 to 20 V	0 to 35 V	0 to 60 V	0 to 120 V
Output current	0 to 220 A	0 to 100 A	0 to 60 A	0 to 35 A	0 to 18 A
Programming accuracy at 25°C ±5°C					
Voltage	0.04% + 8 mV	20 mV	35 mV	60 mV	120 mV
Current	0.1% + 125 mA	60 mA	40 mA	25 mA	12 mA
Ripple and noise					
from 20 Hz to 20 MHz					
Voltage rms	650 µV	750 µV	800 µV	1.25 mV	1.9 mV
Voltage peak to peak	7 mV	9 mV	9 mV	11 mV	16 mV
Current rms	200 mA	100 mA	40 mA	25 mA	12 mA
Readback accuracy at 25°C ±5°C (percent of reading plus fixed)					
Voltage	0.05% + 12 mV	30 mV	50 mV	90 mV	180 mV
±Current	0.1% + 150 mA	100 mA	60 mA	35 mA	18 mA
Load and line regulation					
Voltage	0.002%+ 300 µV	650 µV	1.2 mV	2 mV	4 mV
Current	0.005%+ 10 mA	7 mA	4 mA	2 mA	1 mA
Transient response time	Less than 900 µs for the output voltage to recover 100 mV following a change in load from 100% to 50% or 50% to 100% of the output current rating of the supply				
Supplemental Characteristics	(Non-warranted characteristics determined by design and useful in applying the product)				
Average resolution					
Voltage	2 mV	5 mV	10 mV	15 mV	30 mV
Current	55 mA	25 mA	15 mA	8.75 mA	4.5 mA
OVP	15 mV	35 mV	65 mV	100 mV	215 mV
Output Voltage programming response time*					
(excluding command processing time)	30 ms	60 ms	130 ms	130 ms	195 ms

* Full load programming rise/fall time (10% to 90% or 90% to 10%) with full resistive load equal to rated output voltage/rated output current.

Single-Output: 2000 W GPIB (Continued)

Application notes

6671A/72A/81A/82A/90A
System DC Power Supplies Product Overview
 5988-3050EN

Agilent DC Power Supplies for
Base Station Testing
 5988-2386EN

10 Practical Tips You Need to Know
About Your Power Products
 5965-8239E

Specifications (at 0° to 55°C unless otherwise specified)		6671A-J03 Special order option	6671A-J04 Special order option	6671A-J08 Special order option	6671A-J17 Special order option	6672A-J04 Special order option	6673A-J03 Special order option
Number of outputs		1	1	1	1	1	1
GPIB		Yes	Yes	Yes	Yes	Yes	Yes
Output ratings							
Output voltage		14 V	10 V	3 V	15 V	24 V	37.5 V
Output current		150 A	200 A	300 A	120 A	85 A	45 A
Programming accuracy at 25°C ±5°C							
Voltage		0.04%+	14 mV	10 mV	4 mV	15 mV	25 mV
Current		0.1%+	90 mA	125 mA	250 mA	90 mA	60 mA
Ripple and noise							
from 20 Hz to 20 MHz							
Voltage rms		1.5 mV	750 µV	1 mV	1.5 mV	1 mV	800 µV
Voltage peak to peak		15 mV	9 mV	25 mV	15 mV	11 mV	9 mV
Current rms		150 mA	200 mA	275 mA	150 mA	100 mA	40 mA
Readback accuracy at 25°C ±5°C (percent of reading plus fixed) System models only							
Voltage		0.05% +	25 mV	15 mV	6 mV	27 mV	40 mV
±Current		0.1% +	110 mA	150 mA	250 mA	110 mA	60 mA
Load and line regulation							
Voltage		0.002%+	600 µV	300 µV	300 µV	650 µV	650 µV
Current		0.005%+	7 mA	10 mA	15 mA	7 mA	7 mA
Transient response time		Less than 900 µs for the output voltage to recover 100 mV following a change in load from 100% to 50% or 50% to 100% of the output current rating of the supply					
Supplemental Characteristics		(Non-warranted characteristics determined by design and useful in applying the product)					
Average resolution							
Voltage		4 mV	2.5 mV	1 mV	4 mV	6 mV	10 mV
Current		40 mA	55 mA	75 mA	35 mA	22 mA	15 mA
OVP		28 mV	20 mV	8 mV	30 mV	42 mV	65 mV
Output voltage programming response time*							
(excluding command programming processing time)		30 ms	35 ms	30 ms	35 ms	70 ms	130 ms

* Full load programming rise/fall time (10% to 90% or 90% to 10%) with full resistive load equal to rated output voltage/rated output current.

Single-Output: 2000 W GPIB (Continued)

Supplemental characteristics for all model numbers

DC floating voltage: Output terminals can be floated up to ±240 VDC from chassis ground

Output common-mode noise current: (to signal ground binding post) 500 µArms, 4 mA peak-to-peak

Remote sensing: Up to half the rated output voltage can be dropped in each load lead. The drop in the load leads subtracts from the voltage available for the load.

Command processing time: Average time required for the output voltage to begin to change following receipt of digital data is 20 ms for the power supplies connected directly to the GPIB.

Modulation: (Analog programming of output voltage and current)

Input signal: 0 to -4 V for voltage, 0 to 7 V for current

Input impedance: 60 kΩ or greater

Input power: 3,800 VA, 2,600 W at full load; 170 W at no load

GPIB interface capabilities: SH1, AH1, T6, L4, SR1, RL1, PP0, DC1, DT1, E1, and C0. IEEE-488.2 and SCPI-compatible command set

Software driver:

- IVI-COM
- VXIPlug&Play

Regulatory compliance: Listed to UL1244; certified to CSA556B; conforms to IEC 61010-1.

Size: 425.5 mm W x 132.6 mm H x 640 mm D (16.75 in x 5.22 in x 25.2 in)

Weight: Net, 28.2 kg (62 lbs); shipping, 31.8 kg (70 lbs)

Warranty: Three years

Specifications

(at 0° to 55°C unless otherwise specified)

	6673A-J08 Special order option	6674A-J03 Special order option	6674A-J07 Special order option	6675A-J04 Special order option	6675A-J06 Special order option
Number of outputs	1	1	1	1	1
GPIB	Yes	Yes	Yes	Yes	Yes
Output ratings					
Output voltage	40 V	56 V	50 V	160 V	135 V
Output current	50 A	38 A	42 A	13 A	16 A
Programming accuracy at 25°C ±5°C					
Voltage	0.04%+	40 mV	60 mV	60 mV	160 mV
Current	0.1%+	35 mA	28 mA	30 mA	10 mA
Ripple and noise					
from 20 Hz to 20 MHz					
Voltage rms	1 mV	1.25 mV	1.25 mV	2.8 mV	2 mV
Voltage peak to peak	10.5 mV	11 mV	11 mV	20 mV	18 mV
Current rms	40 mA	28 mA	25 mA	18 mA	12 mA
Readback accuracy at 25°C ±5°C (percent of reading plus fixed)					
System models only					
Voltage	0.05%+	60 mV	90 mV	90 mV	240 mV
±Current	0.1%+	60 mA	38 mA	42 mA	14 mA
Load and line regulation					
Voltage	0.002%+	1.4 mV	2 mV	2 mV	6 mV
Current	0.005%+	4 mA	2 mA	2 mA	1 mA
Transient response time	Less than 900 µs for the output voltage to recover 100 mV following a change in load from 100% to 50% or 50% to 100% of the output current rating of the supply				

Supplemental Characteristics (Non-warranted characteristics determined by design and useful in applying the product)

	6673A-J08	6674A-J03	6674A-J07	6675A-J04	6675A-J06
Average resolution					
Voltage	10.5 mV	14 mV	12 mV	40 mV	34 mV
Current	12.5 mA	9.5 mA	11 mA	3.25 mA	4 mA
OVP	75 mV	100 mV	85 mV	300 mV	242 mV
Output voltage programming response time*					
(excluding command programming processing time)	130 ms	130 ms	130 ms	280 ms	250 ms

* Full load programming rise/fall time (10% to 90% or 90% to 10%) with full resistive load equal to rated output voltage/rated output current.

Single-Output: 2000 W GPIB (Continued)

Ordering information

Opt 200 174 to 220 VAC, 47 to 63 Hz (Japan only)

Opt 230 191 to 250 VAC, 47 to 63 Hz

Opt 0L1 English printed users and programming guide (full documentation on CD-ROM)

Opt 0B3 English printed service manual

A line cord option must be specified, see the AC line voltage and cord section.

Accessories

* **1CM003A** Rack mount flange kit 132.6 mm H (3U) – two flange brackets

* **1CP002A** Rack mount flange and handle kit 132.6 mm H (3U) – two brackets and front handles

p/n 1494-0059 Accessory slide kit

p/n 1252-3698 7-pin analog plug

p/n 1252-1488 4-pin digital plug

p/n 5080-2148 Serial link cable 2 m (6.6 ft)

E3663AC Support rails for Agilent rack cabinets

* Support rails required

Specifications

(at 0° to 55°C unless otherwise specified)

	6675A-J07 Special order option	6675A-J08 Special order option	6675A-J09 Special order option	6675A-J11 Special order option
Number of outputs	1	1	1	1
GPIB	Yes	Yes	Yes	Yes
Output ratings				
Output voltage	200 V	100 V	110 V	150 V
Output current	11 A	22 A	20 A	15 A
Programming accuracy at 25°C ±5°C				
Voltage	0.04%+ 200 mV	120 mV	120 mV	150 mV
Current	0.1%+ 8 mA	15 mA	13.5 mA	11 mA
Ripple and noise				
from 20 Hz to 20 MHz				
Voltage rms	3.5 mV	1.9 mV	1.9 mV	2.5 mV
Voltage peak to peak	25 mV	16 mV	16 mV	18 mV
Current rms	15 mA	15 mA	13.5 mA	12 mA
Readback accuracy at 25°C ±5°C (percent of reading plus fixed) System models only				
Voltage	0.05%+ 300 mV	180 mV	180 mV	225 mV
±Current	0.1%+ 12 mA	22 mA	20 mA	15 mA
Load and line regulation				
Voltage	0.002% + 7 mV	4 mV	4 mV	6 mV
Current	0.005% + 1 mA	4 mV	4 mV	1 mA
Transient response time				
Less than 900 μs for the output voltage to recover 100 mV following a change in load from 100% to 50% or 50% to 100% of the output current rating of the supply				
Supplemental Characteristics (Non-warranted characteristics determined by design and useful in applying the product)				
Average resolution				
Voltage	50 mV	30 mV	30 mV	37.5 mV
Current	2.75 mA	4.5 mA	4.5 mA	3.75 mA
OVP	360 mV	215 mV	215 mV	270 mV
Output voltage programming response time*				
(excluding command programming processing time)	350 ms	195 ms	195 ms	250 ms

* Full load programming rise/fall time (10% to 90% or 90% to 10%) with full resistive load equal to rated output voltage/rated output current.

Single-Output: 2000 W GPIB (Continued)

Agilent Models: 6671A, 6672A, 6673A, 6674A, 6675A

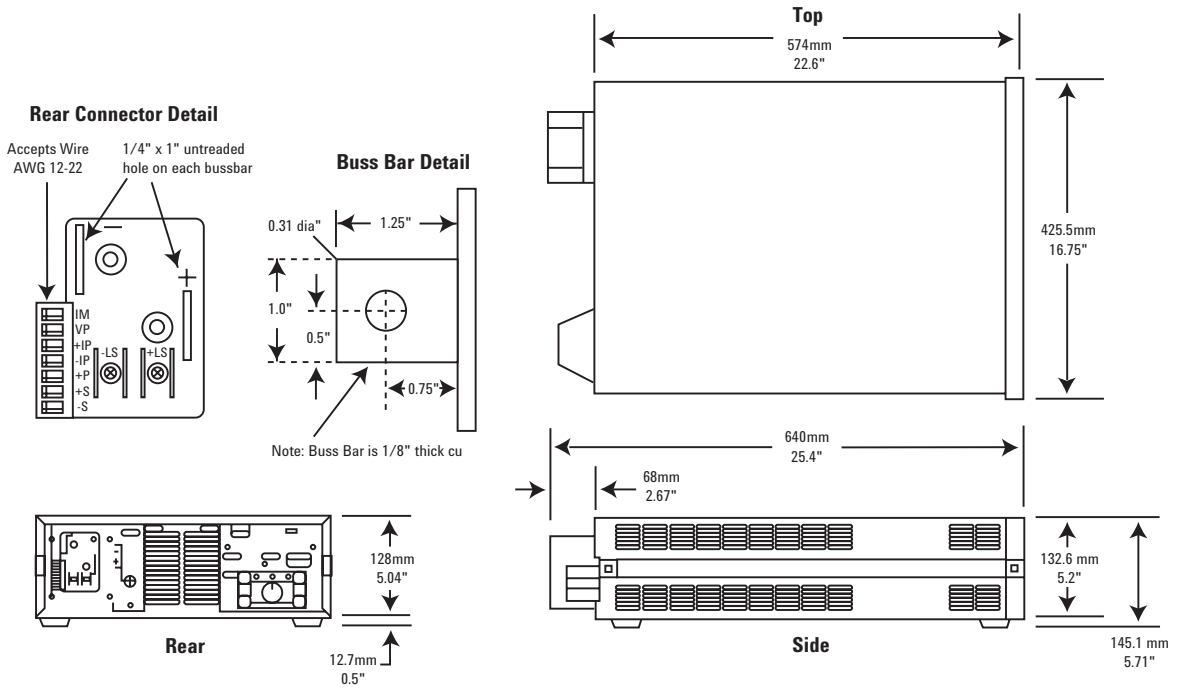

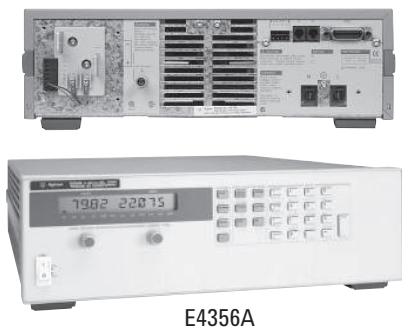

E4356A

Single-Output 2000 W GPIB

- Dual range output
- Fast, low-noise outputs
- Analog control of output voltage and current
- Fan-speed control to minimize acoustic noise
- Built-in measurements and advanced programmable features
- Protection features to ensure DUT safety

Specifications

(at 0° to 55°C unless otherwise specified)

E4356A

This 2000 W DC power supply provides over 2000 watts at either 70 or 80 volts. This makes it particularly suitable for a variety of test scenarios for 48 volt systems. Telephone network equipment is one example of such a 48 volt bus application. It also has the unusual combination of high efficiency and low noise operation.

Programming of the DC output and the extensive protection features can be done either from the front panel or using industry standard SCPI commands, via the GPIB. Using the serial link, up to 16 power supplies can be connected through one GPIB address. Test system integration can be further simplified by using the *VXIPlug&Play* drivers. The output voltage and current can also be controlled with analog signals. This is helpful for certain types of noisy environments, and also immediate reactions to process changes.

Lab-bench use is enhanced by the fan-speed control, which minimizes acoustic noise. The extremely low ripple and noise helps the built-in measurement system make extremely accurate current and voltage measurements.

Number of outputs	1
GPIB	Yes
Output ratings	
Voltage	0 to 70 V/0 to 80 V
Current	0 to 30 A/0 to 26 A
Programming accuracy at 25°C ±5°C (% of setting plus fixed)	
Voltage	0.04% + 80 mV
+Current	0.1% + 25 mA
Ripple and noise	
20 Hz to 20 MHz	
Voltage rms	2 mV
peak-peak	16 mV
Current rms	25 mA
DC measurement accuracy (via GPIB or front panel meters with respect to actual output at 25°C ±5°C)	
Voltage	0.05% + 120 mV
Current	0.1% + 35 mA
Transient response time Time for the output voltage to recover to within 20 mV or 0.1% of the voltage rating of the unit following a change in load current of up to 50% of the output current rating.	<900 µs

Application notes

Agilent DC Power Supplies for Base Station Testing
5988-2386EN

10 Practical Tips You Need to Know About Your Power Products
5965-8239E

10 Hints for Using Your Power Supply to Decrease Test Time
5968-6359E

Supplemental characteristics for all model numbers

DC floating voltage: Output terminals can be floated up to ±240 VDC maximum from chassis ground.

Remote sensing: Up to half the rated output voltage can be dropped in each load lead. The drop in the load leads subtracts from the voltage available for the load.

More detailed specifications at www.agilent.com/find/E4356

Single-Output: 2000 W GPIB (Continued)

Command processing time: Average time required for the output voltage to begin to change following receipt of digital data is 20 ms for the power supplies connected directly to the GPIB. (Display disabled.)

Output voltage rise time/fall time: 100 ms/200 ms for output to change from 90% to 10% or from 10% to 90% of its total excursion with full resistive load (excludes command processing time).

Modulation: (Analog programming of output voltage and current)

Input signal: 0 to -4 V for voltage and current

Input impedance: 60 kΩ nominal

Input power: 3800 VA, 2600 W at full load; 100 W at no load

GPIB interface capabilities: SH1, AH1, TE6, LE4, SR1, RL1, PP0, DC1, DT1, E1 and C0. IEEE-488.2 and SCPI-compatible command set

Software driver:

- IVI-COM
- VXIPlug&Play

Regulatory compliance: Listed to UL1244; certified to CSA556B, conforms to EN61010.

Warranty: Three years

Size: 425.5 mm W x 132.6 mm H x 640 mm D

Weight: 27.7 kg (61 lbs) net, 31.4 kg (69 lbs) shipping.

Ordering information

Opt 200 174 to 220 VAC, 47 to 63 Hz (Japan only)

Opt 230 191 to 250 VAC, 47 to 63 Hz

Opt 0L1 English printed operating manual (full documentation on CD-ROM)

Opt 0B3 English printed service manual

A line cord option must be specified, see the AC line voltage and cord section.

Accessories

* **1CM003A** Rack mount flange kit 132.6 mm H (3U) - two flange brackets

* **1CP002A** Rack mount flange and handle kit 132.6 mm H (3U) - two brackets and front handles

p/n 1494-0059 Accessory slide kit

p/n 1252-3698 7-pin analog plug

p/n 1252-1488 4-pin digital plug

p/n 5080-2148 Serial link cable 2 m (6.6 ft)

E3663AC Support rails for Agilent rack cabinets

* Support rails or slides are required

Agilent Models: E4356A

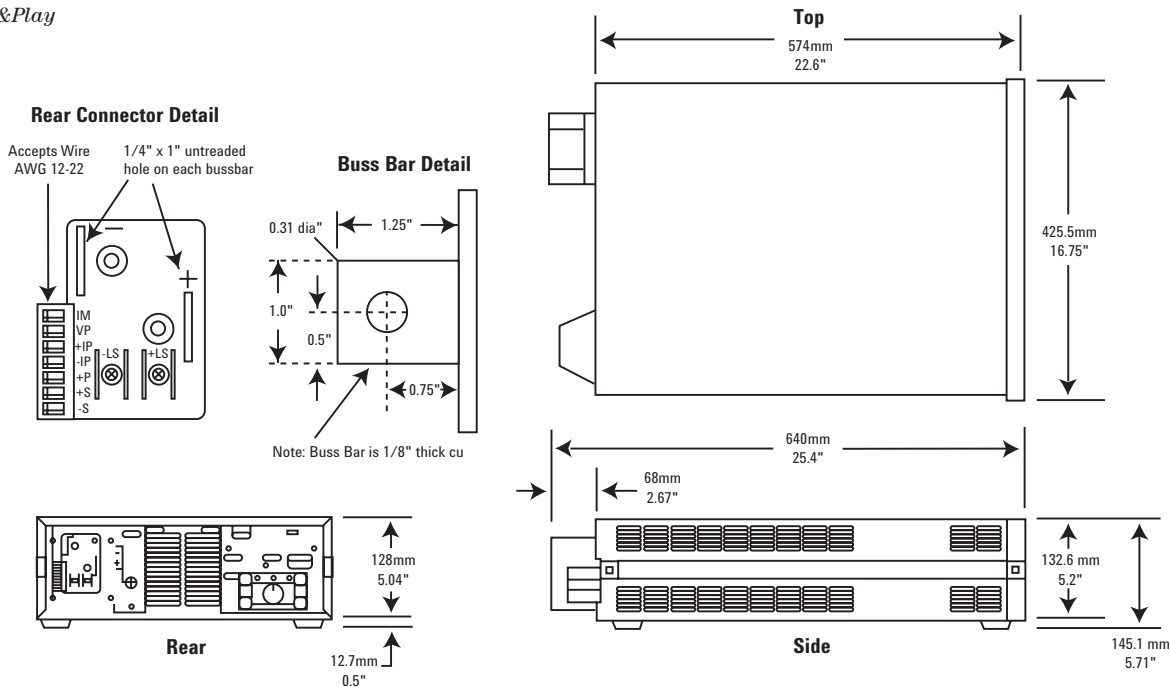

More detailed specifications at www.agilent.com/find/E4356



6571A-6575A

Single-Output 2000 W

- Front panel and analog control of output voltage and current
- Fast, low-noise outputs
- Fan-speed control to minimize acoustic noise
- Protection features to ensure DUT safety

This series of 2000 watt DC power supplies has the exceptional, proven reliability that test system engineers look for. It also has the unusual combination of high efficiency and low noise operation.

These DC power supplies can be controlled either from the front panel or via an analog programming voltage. When used in a test system, the fast up and down programming helps decrease test time. Quickly reacting protection features, including CV/CC mode crossover and over-voltage protection help protect your valuable assemblies from damage.

Lab-bench use is enhanced by the fan-speed control, which minimizes acoustic noise. The extremely low ripple and noise helps the test engineer make extremely accurate current and voltage measurements.

Specifications

(at 0° to 55°C unless otherwise specified)

		6571A	6572A	6573A	6574A	6575A	6571A-J03 Special order option
Number of outputs		1	1	1	1	1	1
GPIB		No	No	No	No	No	No
Output ratings							
Output voltage		0 to 8 V	0 to 20 V	0 to 35 V	0 to 60 V	0 to 120 V	14 V
Output current		0 to 220 A	0 to 100 A	0 to 60 A	0 to 35 A	0 to 18 A	150 A
Programming accuracy at 25°C ±5°C							
Voltage	0.04% +	8 mV	20 mV	35 mV	60 mV	120 mV	14 mV
Current	0.1% +	125 mA	60 mA	40 mA	25 mA	12 mA	90 mA
Ripple and noise from 20 Hz to 20 MHz							
Voltage rms		650 µV	750 µV	800 µV	1.25 mV	1.9 mV	1.5 mV
peak-peak		7 mV	9 mV	9 mV	11 mV	16 mV	15 mV
Current rms		200 mA	100 mA	40 mA	25 mA	12 mA	150 mA
Load regulation and line regulation							
Voltage	0.002%+	300 µV	650 µV	1.2 mV	2 mV	4 mV	600 µV
Current	0.005%+	10 mA	7 mA	4 mA	2 mA	1 mA	7 mA
Transient response time		Less than 900 µs for the output voltage to recover 100 mV following a change in load from 100% to 50% or 50% to 100% of the output current rating of the supply					
Supplemental Characteristics		(Non-warranted characteristics determined by design and useful in applying the product)					
Average resolution							
Voltage		2 mV	5 mV	9 mV	15 mV	30 mV	4 mV
Current		55 mA	25 mA	15 mA	8.75 mA	4.5 mA	40 mA
OVP		15 mV	35 mV	65 mV	100 mV	215 mV	28 mV
Output voltage programming response time*							
*Full load programming rise/fall time (10% to 90% or 90% to 10%) with full resistive load equal to rated output voltage/rated output current.		30 ms	60 ms	130 ms	130 ms	195 ms	30 ms

Single-Output: 2000 W (Continued)

Application notes

Agilent DC Power Supplies for Base Station Testing

5988-2386EN

10 Practical Tips You Need to Know About Your Power Products

5965-8239E

Supplemental characteristics for all model numbers

DC floating voltage: Output terminals can be floated up to ± 240 VDC from chassis ground

Output common-mode noise current: (to signal ground binding post) 500 μ Arms, 4 mA peak-to-peak

Remote sensing: Up to half the rated output voltage can be dropped in each load lead. The drop in the load leads subtracts from the voltage available for the load.

Modulation: (Analog programming of output voltage and current)

Input signal: 0 to -4 V for voltage, 0 to 7 V for current

Input impedance: 30 k Ω or greater

Input power: 3,800 VA, 2,600 W at full load; 170 W at no load

Regulatory compliance: Listed to UL1244; certified to CSA556B; conforms to IEC 61010-1.

Size: 425.5 mm W x 132.6 mm H x 640 mm D (16.75 in x 5.22 in x 25.2 in)

Weight: Net, 28.2 kg (62 lb); shipping, 31.8 kg (70 lb)

Warranty: Three years

Specifications

(at 0° to 55°C unless otherwise specified)

	6571A-J04 Special order option	6571A-J17 Special order option	6573A-J03 Special order option	6573A-J08 Special order option	6574A-J03 Special order option	6574A-J07 Special order option
Number of outputs	1	1	1	1	1	1
GPIOB	No	No	No	No	No	No
Output ratings						
Output voltage	10 V	15 V	37.5 V	40 V	56 V	50 V
Output current	200 A	120 A	45 A	50 A	38 A	42 A
Programming accuracy at 25°C $\pm 5^\circ$C						
Voltage	0.04% +	10 mV	15 mV	37.5 mV	40 mV	60 mV
Current	0.1% +	125 mA	90 mA	40 mA	35 mA	28 mA
Ripple and noise from 20 Hz to 20 MHz						
Voltage rms	750 μ V	1.5 mV	800 μ V	1 mV	1.25 mV	1.25 mV
peak-peak	9 mV	15 mV	9 mV	10.5 mV	11 mV	11 mV
Current rms	200 mA	150 mA	40 mA	40 mA	28 mA	25 mA
Load regulation and line regulation						
Voltage	0.002%+	300 μ V	650 μ V	1.2 mV	1.4 mV	2 mV
Current	0.005%+	10 mA	7 mA	4 mA	4 mA	2 mA
Transient response time	Less than 900 μ s for the output voltage to recover 100 mV following a change in load from response time 100% to 50% or 50% to 100% of the output current rating of the supply					
Supplemental Characteristics (Non-warranted characteristics determined by design and useful in applying the product)						
Average resolution						
Voltage	2.5 mV	4 mV	10 mV	10.5 mV	14 mV	12 mV
Current	55 mA	35 mA	15 mA	12.5 mA	9.5 mA	11 mA
OVP	20 mV	30 mV	65 mV	75 mV	100 mV	85 mV
Output voltage programming response time*						
*Full load programming rise/fall time (10% to 90% or 90% to 10%) with full resistive load equal to rated output voltage/rated output current.	35 ms	35 ms	130 ms	130 ms	130 ms	130 ms

Single-Output: 2000 W (Continued)

Ordering information

Opt 200 174 to 220 VAC, 47 to 63 Hz (Japan only)

Opt 230 191 to 250 VAC, 47 to 63 Hz

Opt 0L1 English printed operating manual (full documentation on CD-ROM)

Opt 0B3 English printed service manual

A line cord option must be specified, see the AC line voltage and cord section.

Accessories

* **1CM003A** Rack mount flange kit 132.6 mm H (3U) - two flange brackets

* **1CP002A** Rack mount flange and handle kit 132.6 mm H (3U) - two brackets and front handles

p/n 1494-0059 Accessory slide kit

E3663AC Support rails for Agilent rack cabinets

* Support rails required

Specifications (at 0° to 55°C unless otherwise specified)	6575A-J04 Special order option	6575A-J06 Special order option	6575A-J07 Special order option	6575A-J08 Special order option	6575A-J09 Special order option	6575A-J11 Special order option
Number of outputs	1	1	1	1	1	1
GPIO	No	No	No	No	No	No
Output ratings						
Output voltage	160 V	135 V	200 V	100 V	110 V	150 V
Output current	13 A	16 A	11 A	22 A	20 A	15 A
Programming accuracy at 25°C ±5°C						
Voltage	0.04% +	160 mV	125 mV	200 mV	120 mV	120 mV
Current	0.1% +	10 mA	12 mA	8 mA	15 mA	13.5 mA
Ripple and noise from 20 Hz to 20 MHz						
Voltage rms	2.8 mV	2 mV	3.5 mV	1.9 mV	1.9 mV	2.5 mV
peak-peak	20 mV	18 mV	25 mV	16 mV	16 mV	18 mV
Current rms	18 mA	12 mA	15 mA	15 mA	13.5 mA	12 mA
Load regulation and line regulation						
Voltage	0.002%+	6 mV	4 mV	7 mV	4 mV	4 mV
Current	0.005%+	1 mA	4 mV	1 mA	4 mV	4 mV
Transient response time	Less than 900 μs for the output voltage to recover 100 mV following a change in load from response time 100% to 50% or 50% to 100% of the output current rating of the supply					
Supplemental Characteristics (Non-warranted characteristics determined by design and useful in applying the product)						
Average resolution						
Voltage	40 mV	34 mV	50 mV	30 mV	30 mV	37.5 mV
Current	3.25 mA	4 mA	2.75 mA	4.5 mA	4.5 mA	3.75 mA
OVP	300 mV	242 mV	360 mV	215 mV	215 mV	270 mV
Output voltage programming response time*						
*Full load programming rise/fall time (10% to 90% or 90% to 10%) with full resistive load equal to rated output voltage/rated output current.	280 ms	250 ms	350 ms	195 ms	195 ms	250 ms

Single-Output: 2000 W (Continued)

Agilent Models: 6571A, 6572A, 6573A, 6574A, 6575A

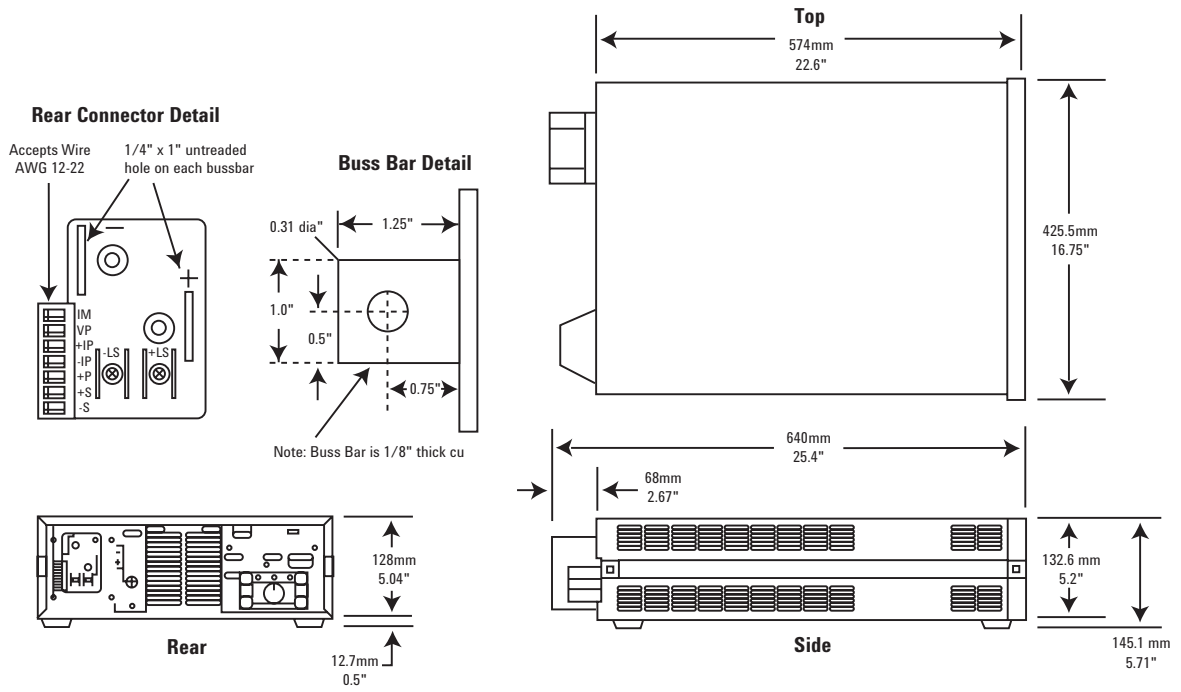



6680A-6684A

Single-Output 5000 W GPIB

- Low output ripple and noise
- Selectable compensation for inductive loads
- Analog control of output voltage and current
- Fan-speed control to minimize acoustic noise
- Built-in measurements and advanced programmable features
- Protection features to ensure DUT safety

Reliable DC power for manufacturing test and long-term burn-In

This series of 5000 watt DC power supplies has the exceptional, proven reliability that test system engineers look for. It also has the features needed for easy test system integration.

Programming of the DC output and the extensive protection features can be done either from the front panel or using industry standard SCPI commands, via the GPIB. Using the serial link, up to 16 power supplies can be connected through one GPIB address. Test system integration can be further simplified by using the VXIPlug&Play drivers. The output voltage and current can also be controlled with analog signals. This is helpful for certain types of noisy environments, and also immediate reactions to process changes.

The 6680A series has extremely low ripple and noise for a 5000 watt DC power supply. This helps the built-in measurement system make extremely accurate current and voltage measurements.

Selectable compensation is provided for problem-free powering of inductive loads.

Specifications

(at 0° to 55°C unless otherwise specified)

	6680A	6681A	6682A	6683A	6684A	6680A-J04 Special order option
Number of outputs	1	1	1	1	1	1
GPIB	Yes	Yes	Yes	Yes	Yes	Yes
Output ratings						
Voltage	0 to 5 V	0 to 8 V	0 to 21 V	0 to 32 V	0 to 40 V	0 to 3.3 V
Current (40°C then derate linearly 1%/°C from 40°C to 55°C)	0 to 875 A	0 to 580 A	0 to 240 A	0 to 160 A	0 to 128 A	0 to 1000 A
Programming accuracy at 25°C ±5°C						
Voltage	0.04% + 5 mV	8 mV	21 mV	32 mV	40 mV	5 mV
Current	0.1% + 450 mA	300 mA	125 mA	85 mA	65 mA	450 mV
Ripple and noise constant voltage mode from 20 Hz to 20 MHz						
rms	1.5 mV	1.5 mV	1.5 mV	1.0 mV	1.0 mV	3.4 mV
peak to peak	10 mV	10 mV	10 mV	10 mV	10 mV	15 mV
Readback accuracy at 25°C ±5°C (percent of reading plus fixed)						
Voltage	0.05% + 7.5 mV	12 mV	32 mV	48 mV	60 mV	7.5 mV
Current	0.1% + 600 mA	400 mA	165 mA	110 mA	90 mA	600 mA
Load and line regulation						
Voltage	0.002% + 0.19 mV	0.3 mV	0.65 mV	1.1 mV	1.5 mV	0.19 mV
Current	0.005% + 65 mA	40 mA	17 mA	12 mA	9 mA	77 mA
Transient response time	Less than 900 µs for the output voltage to recover within 150 mV following a change in load from 100% to 50%, or 50% to 100% of the output current rating of the supply					
Supplemental Characteristics (Non-warranted characteristics determined by design that are useful in applying this product)						
Ripple and noise constant current mode from 20 Hz to 20 MHz						
rms	290 mA	190 mA	40 mA	28 mA	23 mA	500 mA
Average programming resolution						
Voltage	1.35 mV	2.15 mV	5.7 mV	8.6 mV	10.8 mV	12 mV
Current	235 mA	155 mA	64 mA	43 mA	34 mA	260 mA
OVP	30 mV	45 mV	120 mV	180 mV	225 mV	25 mV
Output voltage programming response time	9 ms	12 ms	45 ms	60 ms	60 ms	9 ms
(excludes command-processing time) Full-load programming rise or fall time (10 to 90% or 90 to 10%, resistive load)						
Output common-mode noise current						
rms	1.5 mA	1.5 mA	3 mA	3 mA	3 mA	2.0 mA
(to signal-ground binding post) peak-to-peak	10 mA	10 mA	20 mA	20 mA	20 mA	12.5 mA

Single-Output: 5000 W GPIB (Continued)

Application notes

6671A/72A/81A/82A/90A

System DC Power Supplies Product Overview
5988-3050EN

Agilent DC Power Supplies for

Base Station Testing

5988-2386EN

10 Practical Tips You Need to Know

About Your Power Products

5965-8239E

Supplemental characteristics for all model numbers

DC floating voltage: Output terminals can be floated up to ± 60 VDC maximum from chassis ground

Remote sensing: Up to half the rated output voltage can be dropped in each load lead. The drop in the load leads subtracts from the voltage available for the load.

Command processing time: Average time required for the output voltage to begin to change following receipt of digital data is 20 ms for power supplies connected directly to the GPIB

Modulation: (analog programming of output voltage and current):

Input signal: 0 to -5 V for voltage,

0 to +5 V for current

Input impedance: 30 k Ω /or greater

AC Input (47 to 63 Hz): 180 to 235 VAC (line-to-line, 3 phase), 27.7 Arms maximum worst case, 21.4 Arms nominal; 360 to 440 Vac, 14.3 Arms maximum worst case, 10.7 Arms nominal (maximum line current includes 5% unbalanced phase voltage condition.) Output voltage derated 5% at 50 Hz and below 200 Vac.

Input power: 7350 VA and 6000 W maximum; 160 W at no load

GPIB interface capabilities: SH1, AH1, T6, L4, SR1, RL1, PP0, DC1, DT1, E1, and C0. IEEE-488.2 and SCPI command set.

Software driver:

- IVI-COM
- VXIPlug&Play

Size: 425.5 mm W x 221.5 mm H x 674.7 mm D (16.75 in x 8.75 in x 25.56 in)

Weight: Net, 51.3 kg (113 lbs); shipping, 63.6 kg (140 lbs)

Warranty: Three years

Ordering information

Opt 208 180 to 235 VAC, 3 phase, 47 to 63 Hz

Opt 400 360 to 440 VAC, 3 phase, 47 to 63 Hz

Opt 602 Two bus bar spacers for paralleling power supplies (p/n 5060-3514)

Opt 0L1 English printed users and programming guide (full documentation on CD-ROM)

Opt 0B3 English printed service manual

Accessories

* **1CM028A** Rack mount flange kit 88.1 mm H (3U) and 132.6 mm H (2U) - 4 brackets (5U total)

* **1CP014A** Double rack mount flange and handle kit 88.1 mm (2U) and 132.6 mm H (3U)

p/n 5060-3513 Three 30-A replacement fuses for 180 to 235 VAC line

p/n 5060-3512 Three 16-A replacement fuses for 360 to 440 VAC line

E3663AC Support rails for Agilent rack cabinets

p/n 5080-2148 Serial link cable 2 m (6.6 ft.)

* Support rails required

Agilent Models: 6680A, 6681A, 6682A, 6683A, 6684A

Bus Bar Detail
3/8" Diameter (6)

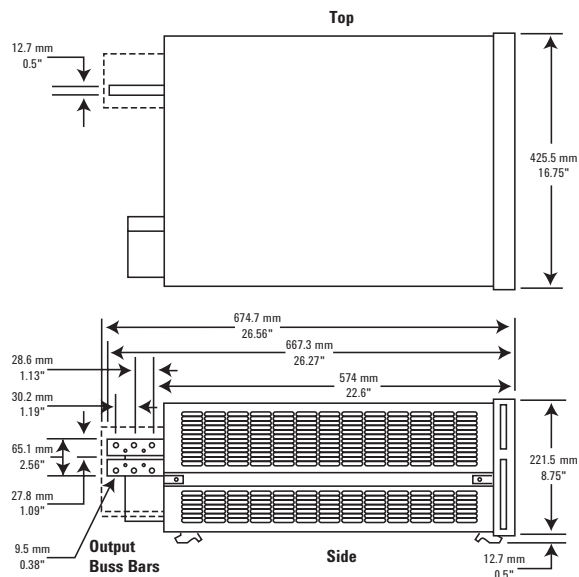
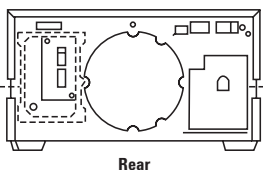
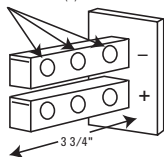



6690A-6692A

Single-Output 6600 W GPIB

- Low output ripple and noise
- Analog control of output voltage and current
- Fan-speed control to minimize acoustic noise
- Built-in measurements and advanced programmable features
- Protection features to ensure DUT safety

Reliable DC power for manufacturing test and long-term burn-in

This series of 6600 watt DC power supplies has the exceptional, proven reliability that test system engineers look for. It also has the features needed for easy test system integration.

Programming of the DC output and the extensive protection features can be done either from the front panel or using industry standard SCPI commands, via the GPIB. Using the serial link, up to 16 power supplies can be connected through one GPIB address. Test system integration can be further simplified by using the VXIPlug&Play drivers. The output voltage and current can also be controlled with analog signals. This is helpful for certain types of noisy environments, and also immediate reactions to process changes.

The 6690A series has extremely low ripple and noise for a 6600 watt DC power supply. This helps the built-in measurement system make extremely accurate current and voltage measurements.

Specifications

(at 0° to 55°C unless otherwise specified)

	6690A	6691A	6692A
Number of outputs	1	1	1
GPIB	Yes	Yes	Yes
Output ratings			
Voltage	0 to 15 V	0 to 30 V	0 to 60 V
Current (derated linearly 1%/°C from 40°C to 55°C)	0 to 440 A	0 to 220 A	0 to 110 A
Programming accuracy at 25°C ±5°C			
Voltage	0.04% + 15 mV	30 mV	60 mV
Current	0.1% + 230 mA	125 mA	65 mA
Ripple and noise constant voltage mode from 20 Hz to 20 MHz			
rms	2.5 mV	2.5 mV	2.5 mV
peak to peak	15 mV	25 mV	25 mV
Readback accuracy at 25°C ±5°C (percent of reading plus fixed offset) System models only			
Voltage	0.05% + 22.5 mV	45 mV	90 mV
Current	0.1% + 300 mA	165 mA	80 mA
Load regulation			
Voltage	0.002% + 0.65 mV	1.1 mV	2.2 mV
Current	0.005% + 40 mA	17 mA	9 mA
Line regulation			
Voltage	0.002% + 0.65 mV	0.65 mV	0.65 mV
Current	0.005% + 40.5 mA	17 mA	9 mA
Transient response time	Less than 900 μs for the output voltage to recover within 150 mV following a change in load from 100% to 50%, or 50% to 100% of the output current rating of the supply		

Application notes

6671A/72A/81A/82A/90A System DC Power Supplies Product Overview
5988-3050EN

Using Agilent 6690A Series System DC Power Supplies for Testing Data Storage Control Boards
(PN 6690A-1)
5988-3062EN

Using Agilent 6690A Series System DC Power Supplies for Automobile Battery Simulation
(PN 6690A-2)
5988-3061EN

More detailed specifications at www.agilent.com/find/6690

Single-Output: 6600 W GPIB (Continued)

Specifications (at 0° to 55°C unless otherwise specified)	6690A	6691A	6692A
--	-------	-------	-------

Supplemental characteristics for all model numbers

DC floating voltage: Output terminal can be floated up to ±60 VDC from chassis ground

Remote sensing: Up to half the rated output voltage can be dropped in each load lead. The drop in the load leads subtracts from the voltage available at the load.

Command processing time: Average time required for the output voltage to begin to change following receipt of digital data is 20 ms for power supplies connected directly to the GPIB.

Modulation: (analog programming of output voltage and current):

Input signal: 0 to -5 V for voltage, and 0 to +5 V for current.

Input impedance: 30 kΩ or greater.

AC input (47 to 63 Hz): 180 to 235 VAC (line-to-line 3 phase) 36 Arms maximum worst case, 28 Arms nominal; 360 to 440 VACX, 18 Arms maximum worst case, 14 Arms nominal. (Maximum line current includes 5% unbalanced phase voltage condition).

Software driver:

- IVI-COM
- VXIPlug&Play

Input power: 9000 VA and 7950 W maximum; 175 W at no load.

Size: 425.5 mm W x 221.5 mm H x 674.7 mm D (16.75 in x 8.75 in x 25.56 in).

Warranty: Three years

Ordering information

Opt 208 180 to 235 VAC, 3 phase, 47 to 63 Hz

Opt 400 360 to 440 VAC, 3 phase, 47 to 63 Hz

Opt 602 Two bus bar spacers for paralleling power supplies (p/n 5060-3514)

Opt 0L1 English printed users and programming guide (full documentation on CD-ROM)

Opt 0B3 English printed service manual

Supplemental Characteristics

(Non-warranted characteristics determined by design that are useful in applying this product)

Ripple and noise constant current mode from 20 Hz to 20 MHz				
	rms	200 mA	50 mA	30 mA
Average programming resolution				
Voltage		4.1 mV	8.1 mV	16 mV
Current		118.5 mA	59 mA	30 mA
OVP		90 mV	170 mV	330 mV
Output voltage programming response time (excludes command-processing time) Full-load programming rise or fall time (10 to 90% or 90 to 10%, resistive load)				
		45 ms	60 ms	100 ms
Output common-mode noise current				
	rms	3 mA	3.5 mA	4 mA
(to signal-ground binding post)	peak-to-peak	20 mA	20 mA	25 mA

Accessories

- * **1CM028A** Rack mount flange kit 88.1 mm H (3U) and 132.6 mm H (2U) - 4 brackets (5U total)
- * **1CP014A** Double rack mount flange and handle kit 88.1 mm (2U) and 132.6 mm H (3U)
- p/n 5065-6935** Replacement fuse kit for 360-440 VAC line.

p/n 5065-6934 Replacement fuse kit for 180-235 VAC line.

E3663AC Support rails for Agilent rack cabinets.

p/n 5080-2148 Serial link cable 2 m (6.6 ft.)

* Support rails required

Agilent Models: 6690A, 6691A, 6692A

Buss Bar Detail
3/8" Diameter (6)

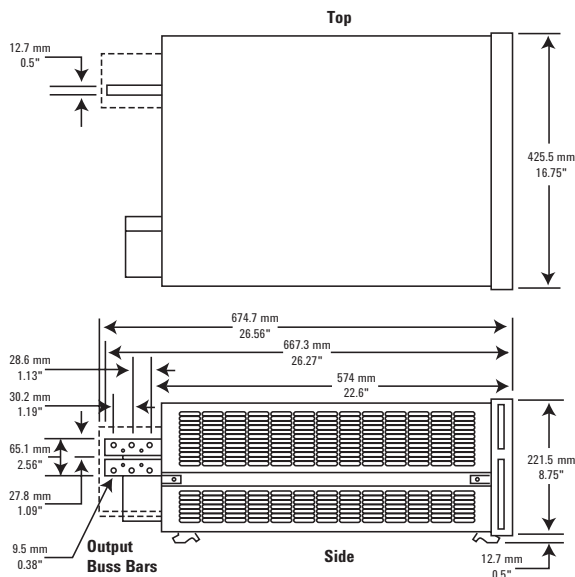
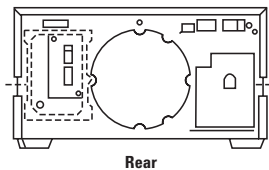
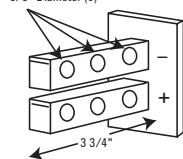

More detailed specifications at www.agilent.com/find/6690



B2961A, B2962A

Low Noise Power Source

B2961A/B2962A 6.5 Digit Low Noise Power Source

Revolutionary power supply for precision low noise voltage/current sourcing
 6.5 digit with 100 nV/10 fA sourcing resolution
 Source up to 210 V/3 A (10.5 A pulse)
 Ultra low noise down to 10 μ Vrms (10 Hz to 20 MHz)
 Innovative sourcing functions (ARB, Output R) and superior GUI

Specifications (at 0° to 55°C unless otherwise specified)	B2961A	B2962A	B2961A B2962A Ultra low noise ¹	B2961A B2962A Low noise ²
--	--------	--------	--	--

The Agilent B2961A/B2962A 6.5 Digit Low Noise Power Source are a new generation of power supply/sources offering 6.5 digit best-in-class precision, wide bipolar output ranges of 100 nV-210 A & 10 fA-10.5 A, and an extremely low noise floor of 10 μ Vrms and 1 nVrms/ $\sqrt{\text{Hz}}$ (at 10 kHz). It also offers innovative features such as graphing capability and arbitrary waveform generation capability (1 mHz-10 kHz), which enable tests and evaluation that conventional power supply/sources cannot do. These features make the B2961A/B2962A ideal companion sources to use with other instruments such as oscilloscopes, network analyzers, spectrum analyzers, frequency counters, digital multi meters, nano-voltmeters, etc. The advanced features of the B2961A/ B2962A provide researchers, electronic development engineers and electronic technicians with the tools that they need to meet their most difficult measurement challenges.

One area where power supply sourcing resolution is important is analog-to-digital converter (ADC) evaluation. For an 8-bit ADC, a 1 V (peak to peak) signal would have a minimum step voltage of 3.9 mV. In this case a power source with 4.5 digit resolution is sufficient to use for the DC input voltage. However, for an ADC with 14-bits or more, 4.5 digit resolution is not

Number of Channels		1	2	1 (B2961A) 2 (B2962A)	1 (B2961A) 2 (B2962A)
Maximum output					
Voltage		210 V	210 V	42 V	210 V
Current	DC	3.03 A	3.03 A	105 mA	3.03 A
	Pulsed	10.5 A	10.5 A	105 mA	10.5 A
Power		31.8 W	31.8 W	4.4 W	31.8 W
Source					
Max digits		6½	6½	6½	6½
Min resolution	Voltage	100 nV	100 nV	100 nV	100 nV
	Current	10 fA	10 fA	10 fA	10 fA
Measurement					
Max digits		4½	4½	4½	4½
Minimum resolution	Voltage	10 μ V	10 μ V	10 μ V	10 μ V
	Current	1 pA	1 pA	1 pA	1 pA
Noise (supplemental characteristics)					
0.1 Hz to 10 Hz		< 5 μ Vpp < 1 pApp	< 5 μ Vpp < 1 pApp	< 5 μ Vpp < 1 pApp	< 5 μ Vpp < 1 pApp
10 Hz to 20 MHz		3 mVrms	3 mVrms	10 μ Vrms ³	350 μ Vrms
Sourcing function					
Arbitrary waveform generation		Yes	Yes	Yes	Yes
Pre-defined waveform (1mHz to 10 KHz)		Sine, Square, Ramp, Triangle, Trapezoid, Exponential			
Programmable output resistance		Yes	Yes	Yes	Yes
View mode					
Single		Yes	Yes	Yes	Yes
Dual			Yes	Yes (B2962A)	Yes (B2962A)
Graph		Yes	Yes	Yes	Yes

Notes:

¹ With N1294A-021 Ultra Low Noise Filter

² With N1294A-022 Low Noise Filter

³ 1 nVrms/ $\sqrt{\text{Hz}}$ @ 10 kHz

enough. In this case the B2961A/B2962A's best-in-class 6.5-digit sourcing resolution is required in order to properly evaluate the ADC circuit.

More detailed specifications at www.agilent.com/find/B2960A

Low Noise Power Source

B2961A/B2962A 6.5 Digit Low Noise Power Source (Continued)

For applications requiring ultra-low noise performance, the Agilent B2961A/B2962A supports two external filter options. This provides you with the flexibility to select the noise filter price/performance point that best meets your needs. The low noise filter (LNF) provides the same level of RMS noise as linear regulator-based power supplies and sources, while the ultra low noise filter (ULNF) reduces noise to an impressive 10 μ Vrms.

Many power supplies and sources only possess a numerical display or a very basic dot matrix display, which are only effective at showing DC values. In contrast, the Agilent B2961A/B2962A has an easy-to-use front panel GUI and a wide 4.3" color LCD. These make it easy to set up sourcing parameters and to display complex current and voltage waveforms. For added convenience, the Agilent B2961A/B2962A provides multiple viewing modes: single view, dual view (B2962A only) and graph view. These capabilities not only increase test and evaluation efficiency, but they also make the instrument easy to use without the need to struggle through paper manuals.

Key features and benefits:

World's only source with 6.5 digit resolution and a wide bipolar range of 100 nV - 210 V/10 fA - 10.5 A

The Agilent B2961A/B2962A Power Sources have broad voltage (up to ± 210 V) and current (up to ± 3 A DC and ± 10.5 A pulsed) sourcing ranges and excellent 6.5 digit resolution (minimum 100 nV/10 fA program resolution). This enables you to source voltage from 100 nV to 210 V and current from 10 fA to 3 A DC/10.5 A pulsed in a single box. Unlike a typical power supply/source, they support 4-quadrant operation that gives you the freedom to accurately and precisely supply any voltage or current contained within their ranges and power limit (31.8 W) regardless of polarity.

Best-in-class noise floor of 10 μ Vrms (1 nVrms/ $\sqrt{\text{Hz}}$ @10 kHz) outperforms that of even linear power supplies

Low noise performance is required for the development of noise sensitive applications such as VCOs (voltage controlled oscillators), ADC/DAC, new material evaluation, etc. However, conventional power supplies and sources have not been able to achieve the noise levels to meet these needs. The Agilent B2961A/B2962A supports an optional external filter that enables ultra-low noise output down to 10 μ Vrms and 1 nVrms/ $\sqrt{\text{Hz}}$ (at 10 kHz), which has never before been possible on a low-cost bench-top source.

Quick front-panel debug and verification

The Agilent B2961A/B2962A have a 4.3 inch wide LCD display, and all of their capabilities are accessible from the front-panel graphical user interface (GUI). The graphical display not only simplifies user-operation, but it also facilitates viewing measurement results. In addition to their built-in 4.5 digit voltage and current monitoring capability, the Agilent B2961A/B2962A can display results in numerical or graphical (V-t/I-t) formats on their screen. This permits quick checking and debugging of measurement results without the need for additional equipment.

Flexible arbitrary waveform generation capabilities provide more flexibility than simple DC

In addition to DC output, the Agilent B2961A/B2962A has the ability to generate pulsed, swept and arbitrary waveforms in both voltage and current anywhere within its wide output range. Its arbitrary waveform generation capability supports common waveform types (sine, ramp, square, etc.) in addition to user-defined waveforms. This provides a great deal of versatility and allows the B2961A/B2962A to be used in many complex applications.

The ability to emulate many types of voltage and current characteristics aids device evaluation

The programmable output resistance feature allows you to specify either an output resistance (positive or negative) or a specific voltage vs. current source characteristic. This feature is ideal for emulating a wide variety of devices (such as batteries, photovoltaic cells, sensors, transducers, etc.) that are otherwise difficult to simulate.

Low Noise Power Source

B2961A/B2962A 6.5 Digit Low Noise Power Source (Continued)

Graphical User Interface (GUI) image:

Single view mode

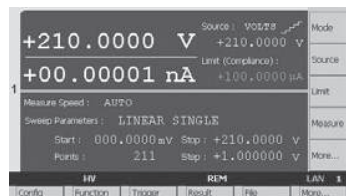

Dual view mode

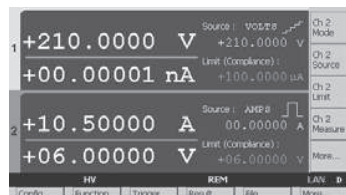

Graph view mode

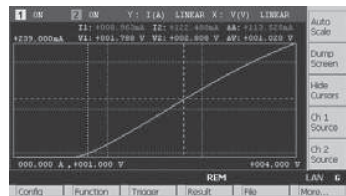

Roll view mode

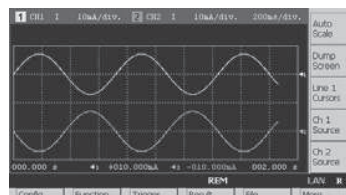

Ramp

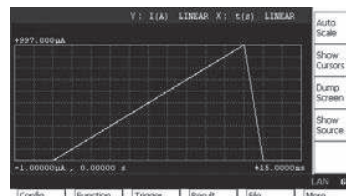

Key B2960A series accessories:

- N1294A-001** Banana - Triax Adapter for 2-wire (non Kelvin) connection
- N1294A-002** Banana - Triax Adapter for 4-wire (Kelvin) connection
- N1294A-011** Interlock cable for 16442B (1.5 m)
- N1294A-012** Interlock cable for 16442B (3.0 m)
- N1294A-021** Ultra-low noise filter (42 V/105 mA) for B2961A/62A
- N1294A-022** Low noise filter (210 V/3 A) for B2961A/62A
- N1294A-031** GPIO-BNC Trigger Adapter
- N1295A** Device/Component Test Fixture

Ordering information:

- B2961A** 6.5 Digit Low Noise Power Source: 32 W, 210 V, 3 A, 1 channel
- B2962A** 6.5 Digit Low Noise Power Source: 32 W, 210 V, 3 A, 2 channel

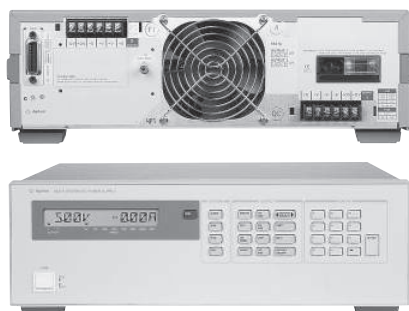

6621A-6624A, 6627A

Multiple-Output 40 W-105 W GPIB

- Up to four fully isolated power supplies in a 3U package
- Dual-range outputs
- Fast, low-noise outputs
- Built-in measurements and advanced programmable features
- Protection features to ensure DUT safety

Two, three, or four isolated outputs are integrated into one package, conserving rack space and GPIB addresses. Most of the outputs also provide dual ranges, for more current at lower voltage levels. The outputs can be connected in parallel or series to further increase the flexibility that these products offer the system designer.

Programming is done using industry standard SCPI commands. Test system integration can be further simplified by using the *VXIPlug&Play* drivers. These power supplies help reduce test time with fast up and down programming, which is enhanced by an active downprogrammer which can sink the full rated current.

Application notes

10 Practical Tips You Need to Know About Your Power Products
5965-8239E

10 Hints for Using Your Power Supply to Decrease Test Time
5968-6359E

Understanding Linear Power Supply Operation
(AN1554)
5989-2291EN

Modern Connectivity - Using USB and LAN I/O Converters
(AN 1475-1)
5989-0123EN

Specifications

(at 0° to 55°C unless otherwise specified)

		40 W output	40 W output	80 W output	80 W output	105 W output
Output power	Low-range volts, amps	0 to 7 V, 0 to 5 A	0 to 20 V, 0 to 2 A	0 to 7 V, 0 to 10 A	0 to 20 V, 0 to 4 A	0-35 V, 0-3 A
	High range volts, amps	0 to 20 V, 0 to 2 A	0 to 50 V, 0 to 0.8 A	0 to 20 V, 0 to 4 A	0 to 50 V, 0 to 2 A	—
Output combinations for each model (total number of outputs)						
	6621A (2)	—	—	2	—	—
	6622A (2)	—	—	—	2	—
	6623A (3)	1	1	1	—	—
	6624A (4)	2	2	—	—	—
	6627A (4)	—	4	—	—	—
	6623A-J03 (3) Special order option	—	2	—	—	1
Programming accuracy	Voltage	19 mV + 0.06%	50 mV + 0.06%	19 mV + 0.06%	50 mV + 0.06%	35 mV + 0.06%
	Current	50 mA + 0.16%	20 mA + 0.16%	100 mA + 0.16%	40 mA + 0.16%	30 mA + 0.16%
Readback accuracy (at 25°C ±5°C)	Voltage	20 mV + 0.05%	50 mV + 0.05%	20 mV + 0.05%	50 mV + 0.05%	35 mV + 0.05%
	+Current	10 mA + 0.1%	4 mA + 0.1%	20 mA + 0.1%	8 mA + 0.1%	6 mA + 0.1%
	-Current	25 mA + 0.2%	8 mA + 0.2%	50 mA + 0.2%	20 mA + 0.2%	15 mA + 0.2%
Ripple and noise (peak-to-peak, 20 Hz to 20 MHz; rms, 20 Hz to 10 MHz)						
	Constant voltage rms	500 µV	500 µV	500 µV	500 µV	500 µV
	peak-to-peak	3 mV	3 mV	3 mV	3 mV	3 mV
	Constant current rms	1 mA	1 mA	1 mA	1 mA	1 mA
Load regulation	Voltage	2 mV	2 mV	2 mV	2 mV	2 mV
	Current	1 mA	0.5 mA	2 mA	1 mA	2 mA
Load cross regulation	Voltage	1 mV	2.5 mV	1 mV	2.5 mV	N/A
	Current	1 mA	0.5 mA	2 mA	1 mA	N/A
Line regulation	Voltage	0.01% + 1 mV	0.01% + 1 mV	0.01% + 1 mV	0.01% + 1 mV	0.01% + 1 mV
	Current	0.06% + 1 mA	0.06% + 1 mA	0.06% + 1 mA	0.06% + 1 mA	0.06% + 1 mA

Transient response time Less than 75 µs for the output to recover to within 75 mV of nominal value following a load change within specifications

More detailed specifications at www.agilent.com/find/6620

Multiple-Output: 40 W-105 W GPIB (Continued)

Specifications <small>(at 0° to 55°C unless otherwise specified)</small>	40 W output	40 W output	80 W output	80 W output	105 W output
---	-------------	-------------	-------------	-------------	--------------

Supplemental characteristics for all model numbers

DC floating voltage: All outputs can be floated up to ±240 VDC from chassis ground

Remote sensing: Up to 1 V drop per load lead. The drop in the load leads is subtracted from the voltage available for the load.

Command processing time: 7 ms typical with front-panel display disabled

Down programming: Current sink limits are fixed approximately 10% higher than source limits for a given operating voltage above 2.5 V

Input power: 550 W max., 720 VA max.

GPIB interface capabilities: SH1, AH1, T6, L4, SR1, RL1, PP1, DC1, DT0.

Software driver:
VXIPlug&Play

Regulatory compliance: Listed to UL1244; conforms to IEC 61010-1; carries the CE mark.

Size: 425.5 mm W x 132.6 mm H x 497.8 mm D (16.75 in x 5.22 in x 19.6 in)

Weight: Net, 17.4 kg (38 lb); shipping, 22.7 kg (50 lb)

Warranty: Three years

Ordering information

- Opt 100** 87 to 106 VAC, 47 to 66 Hz input, 6.3 A (Japan only)
- Opt 120** 104 to 127 VAC, 47 to 63 Hz
- Opt 220** 191 to 233 VAC, 47 to 66 Hz, 3.0 A
- Opt 240** 209 to 250 VAC, 47 to 66 Hz, 3.0 A
- Opt 750** Relay Control and DFI/RI
- Opt S50** Similar to option 750, however the remote inhibit does not latch
- Opt 0L1** English printed operating manual (full documentation on CD-ROM)
- Opt 0B3** English printed service manual

Supplemental Characteristics

(Non-warranted characteristics determined by design and useful in applying the product)

Average programming resolution	Voltage	6 mV	15 mV	6 mV 20 mV (high)	6 mV 20 mV (high)	10.5 mV
	Current	25 mA	10 mA	50 mA 20 mA (high)	50 mA 20 mA (high)	15 mA
OVP		100 mV	250 mV	100 mV 2	50 mV	175 mV
Output programming response time (time to settle within 0.1% of full scale output, after Vset command has been processed)		2 ms	6 ms	2 ms	6 ms	6 ms

Accessories

- * **1CM003A** Rack mount flange kit
132.6 mm H (3U) - two flange brackets
- * **1CP002A** Rack mount flange and handle kit
132.6 mm H (3U) - two brackets and front handles
- p/n 1494-0059** Rack slide kit

E3663A Support rails for Agilent rack cabinets
* Support rails required

Agilent Models: 6621A, 6622A, 6623A, 6624A, 6627A

Terminal Strip Detail

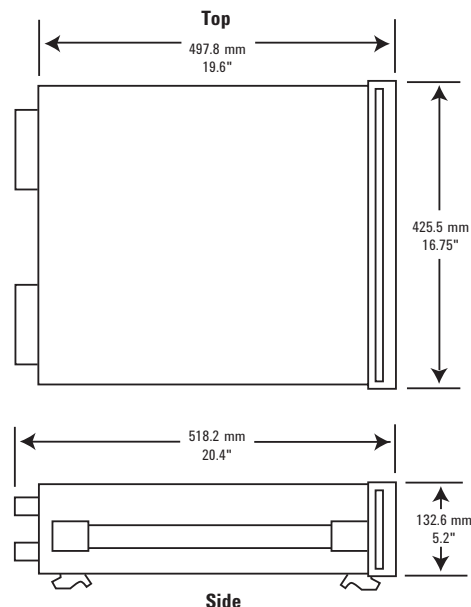
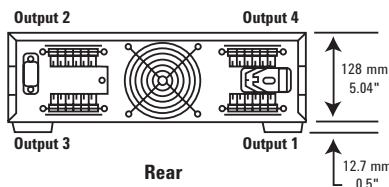
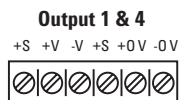
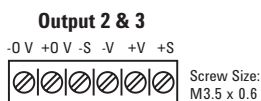



6625A, 6626A, 6628A, 6629A

Precision Multiple-Output 25 W-50 W GPIB

- Up to four fully isolated power supplies in a 3U package
- Fast, low-noise outputs
- Dual-range, precision low current measurement
- Built-in measurements and advanced programmable features
- Protection features to ensure DUT safety

Specifications

(at 0° to 55°C unless otherwise specified)

25 W output

50 W output

Two or four isolated outputs are integrated into one package, conserving rack space and GPIB addresses. Dual ranges allow for more current at lower voltage levels. The outputs can be connected in parallel or series to further increase the flexibility that these products offer the system designer. Programming is done using industry standard SCPI commands and test system integration can be further simplified by using the VXIPlug&Play drivers. These power supplies help reduce test time with fast up and down programming, which is enhanced by the active down-programmer which can sink the full rated current.

These power supplies are very useful on the R&D bench. The accuracy of both the programming and the measurement systems allow precise control and monitoring of prototype bias power. The extensive protection features protect valuable prototypes, including very fast CV/CC crossover. The power supply can be controlled from either the front panel keypad or, for automated testing, from the GPIB.

		25 W output	50 W output
Output power	Low-range volts, amps	0 to 7 V, 0 to 15 mA	0 to 16 V, 0 to 200 mA
	High range volts, amps	0 to 50 V, 0 to 500 mA	0 to 50 V, 0 to 1 A or 0 to 16 V, 0 to 2 A
Output combinations for each model (total number of outputs)	6625A (2) precision	1	1
	6626A (4) precision	2	2
	6628A (2) precision	—	2
	6629A (4) precision	—	4
Programming accuracy (at 25°C ±5°C)	Voltage	1.5 mV + 0.016% (low) 10 mV + 0.016% (high)	3 mV + 0.016% (low) 10 mV + 0.016% (high)
	Current	15 µA + 0.04% (low) 100 µA + 0.04% (high)	185 µA + 0.04% (low) 500 µA + 0.04% (high)
Readback accuracy (at 25°C ±5°C)	Voltage	0.016% + 2 mV (low) 0.016% + 10 mV (high)	0.016% + 3.5 mV (low) 0.016% + 10 mV (high)
	±Current	0.03% + 15 µA (low) 0.03% + 130 µA (high)	0.04% + 250 µA (low) 0.04% + 550 µA (high)
Ripple and noise (peak-to-peak, 20 Hz to 20 MHz; rms, 20 Hz to 10 MHz)	Constant voltage rms	500 µV	500 µV
	peak-to-peak	3 mV	3 mV
Load regulation	Constant current rms	0.1 mA	0.1 mA
	Voltage	0.5 mV	0.5 mV
Load cross regulation	Current	0.005 mA	0.01 mA
	Voltage	0.25 mV	0.25 mV
Line regulation	Current	0.005 mA	0.01 mA
	Voltage	0.5 mV	0.5 mV
Transient response time change within specifications	Voltage	0.5 mV	0.5 mV
	Current	0.005 mA	0.01 mA
Supplemental Characteristics (Non-warranted characteristics determined by design and useful in applying the product)			
Average programming resolution	Voltage	460 µV (low)	1 mV (low)
		3.2 mV (high)	3.2 mV (high)
	Current	1 µA (low)	13 µA (low)
		33 µA (high)	131 µA (high)
OVP	230 mV	230 mV	
Output programming response time (time to settle within 0.1% of full scale output, after Vset command has been processed)		6 ms	6 ms

Precision Multiple-Output: 25 W-50 W GPIB (Continued)

Application notes

10 Practical Tips You Need to Know About Your Power Products
5965-8239E

10 Hints for Using Your Power Supply to Decrease Test Time
5968-6359E

Understanding Linear Power Supply Operation
(AN1554)
5989-2291EN

Modern Connectivity - Using USB and LAN I/O Converters
(AN 1475-1)
5989-0123EN

Supplemental characteristics for all model numbers

DC floating voltage: All outputs can be floated up to ±240 VDC from chassis ground

Remote sensing: Up to 10 V drop per load lead. The drop in the load leads is subtracted from the voltage available for the load.

Command processing time: 7 ms typical with front-panel display disabled

Input power: 550 W max., 720 VA max.

GPIB interface capabilities: SH1, AH1, T6, L4, SR1, RL1, PP1, DC1, DT0, C0, E1.

Software driver:
VXIPlug&Play

Regulatory compliance: Listed to UL 1244; conforms to IEC 61010-1.

Size: 425.5 mm W x 132.6 mm H x 497.8 mm D (16.75 in x 5.22 in x 19.6 in)

Weight: 6626A, 6629A: Net, 17.4 kg (38 lb); shipping, 22.7 kg (50 lb) 6625A, 6628A: Net, 15.5 kg (34 lb); shipping, 20.8 kg (46 lb)

Warranty: Three years

Ordering information

Opt 100 87 to 106 VAC, 47 to 66 Hz input, 6.3 A (Japan only)

Opt 120 104 to 127 VAC, 47 to 63 Hz

Opt 220 191 to 233 VAC, 47 to 66 Hz, 3.0 A

Opt 240 209 to 250 VAC, 47 to 66 Hz, 3.0 A

Opt 750 Relay control and DFI/RI

Opt S50 Similar to option 750, however the remote inhibit does not latch

Opt 0L1 English printed operating manual (full documentation on CD-ROM)

Opt 0B3 English printed service manual

Accessories

* **1CM003A** Rack mount flange kit
132.6 mm H (3U) - two flange brackets

* **1CP002A** Rack mount flange and handle kit
132.6 mm H (3U) - two brackets and front handles

p/n 1494-0059 Rack slide kit

E3663AC Support rails for Agilent rack cabinets

* Support rails required

Agilent Models: 6625A, 6626A, 6628A, 6629A

Terminal Strip Detail

Output 2 & 3

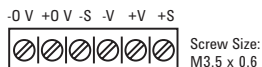

Output 1 & 4

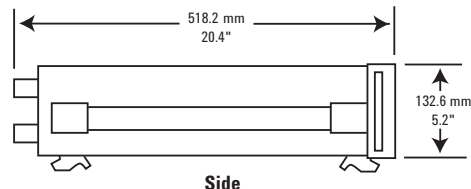
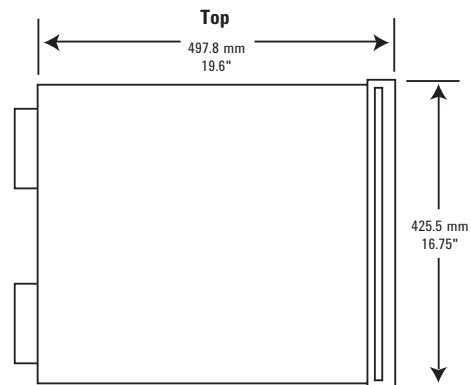
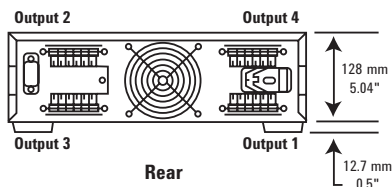
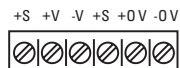

Low-Profile Modular Power System

20-300 W GPIB, LAN, USB, LXI Core



N6700B, N6701A, N6702A, N6731-36B, N6741B-46B, N6751A-N6754A, N6761A-62A, N6773A-N6777A, N6781A-84A (pages 119, 137)

- Small size: up to 4 outputs in 1U of rack space
- More than 30 DC power modules: basic, performance and precision models, and source/measure units
- Fast output programming with active downprogramming
- Ultra fast command processing time
- Output sequencing and advanced triggering system
- Optional LIST mode, built-in digitizer, and disconnect and polarity reversal relays
- N6780 SMU and application-specific modules available (pages 119, 137)

Specifications

(at 0° to 55°C, and derated above 40°C)

	N6751A	N6752A	N6753A	N6754A	N6755A	N6756A
DC output ratings						
Voltage	50 V	50 V	20 V	60 V	20 V	60 V
Current ¹	5 A	10 A	50 A	20 A	50 A	17 A
Power	50 W	100 W	300 W	300 W	500 W	500 W
Programming accuracy (at 23°C ±5°C after 30 minute warm-up. Applies from minimum to maximum programming range)						
Voltage	0.06% + 19 mV	19 mV	10 mV	25 mV	10 mV	25 mV
Current	0.1% + 20 mA	20 mA	30 mA	12 mA	30 mA	12 mA
Voltmeter/ammeter measurement accuracy (at 23°C ±5°C)						
Voltage	0.05% + 20 mV	20 mV	10 mV	25 mV	10 mV	25 mV
Current	0.1% + 4 mA	4 mA	30 mA	8 mA	30 mA	8 mA
Output ripple and noise (PARD) (from 20 Hz to 20 MHz)						
CV peak-to-peak	4.5 mV	4.5 mV	5 mV	6 mV	5 mV	6 mV
CV rms	350 μV	350 μV	1 mV	1 mV	1 mV	1 mV
Load effect (Regulation) (Applies for any output load change, with a maximum load-lead drop of 1 V/lead. The load lead drop reduces the maximum available voltage at the load.)						
Voltage	2 mV	2 mV	2 mV	2 mV	2 mV	2 mV
Current	2 mA	2 mA	12 mA	5 mA	12 mA	5 mA
Source effect (Regulation)						
Voltage	1 mV	1 mV	0.5 mV	1.2 mV	0.5 mV	1.2 mV
Current	1 mA	1 mA	5 mA	2 mA	5 mA	2 mA
Load transient recovery time (Time to recover to within the settling band following a load change.) - from 60% to 100% and from 100% to 60% of full load for model N6751A - from 50% to 100% and from 100% to 50% of full load for models N6752A through N6756A						
Voltage settling band	±75 mV	±75 mV ²	±30 mV ³	±90 mV ⁴	±30 mV ³	±90 mV ⁴
Time	<100 μs	<100 μs	<100 μs	<100 μs	<100 μs	<100 μs

The Agilent N6700 low-profile modular power system (MPS) is a switching regulated, multiple-output programmable DC power supply system with the performance of a linear power supply. The N6700 is a flexible modular platform that allows you to mix and match more than 30 different DC power modules to create a 1- to 4-channel DC power system to optimized performance, power and price to match test needs. Test system engineers can invest in high-performance outputs where speed and accuracy are needed, or purchase basic performance outputs for simple DC power requirements.

Small size

The Agilent N6700 MPS uses an advanced switching power supply design that fits within 1U of rack space. It has side air vents (no top or bottom air vents) so other instruments can be mounted directly above or below it. (Requires rack mount kit).

Protection features

Each N6700 module is protected against over-voltage, over-current, and over-temperature. A fault condition in one module can be detected within 10 microseconds by other modules so that they can be quickly shut down to avoid hazardous conditions on your DUT.

¹ Output current is derated 1% per °C above 40°C.
² When relay option 761 is installed in Model N6752A, the settling band is ±125 mV.
³ When relay option 760 or 761 is installed on Model N6753A and N6755A, the settling band is ±200 mV.
⁴ When relay option 760 or 761 is installed on Model N6754A and N6756A, the settling band is ±350 mV.

More detailed specifications at www.agilent.com/find/N6700

Low-Profile Modular Power System 20-300 W GPIB (Continued)

Specifications

(at 0° to 55°C, and derated above 40°C)

N6751A N6752A N6753A N6754A N6755A N6756A

Connectivity

The N6700 offers many system oriented features to simplify and accelerate test system development. They support the industry standard SCPI commands and come standard with software drivers.

The N6700 MPS comes standard with GPIB, USB 2.0, and 10/100 Base-T Ethernet LAN interfaces. While GPIB is best suited for use with existing systems, Agilent offers USB and LAN to allow you to take advantage of the availability, speed, and ease-of-use of common computer industry standard interfaces.

The N6700 is designed to comply with the LXI Core specification. The N6700 contains a Web server that provides Web pages for monitor, control and setup of the MPS.

Output sequencing

Each DC power module can be individually set to turn on or to turn off with a delay. By adjusting the delay times and then commanding the N6700 to turn on/off, you can set the N6700 modules to sequence on/off in a particular order.

Programmable voltage slew

For some applications, like inrush limiting or powering rate-sensitive devices, it is necessary to slow down and control the speed of the power supply to maintain a specific voltage slew rate. The N6700 provides programmable voltage slew rate, so that with a single command, you can generate a zero to full-scale voltage change controllable from 1 millisecond to 10 seconds.

Supplemental Characteristics

(Non-warranted characteristics determined by design that are useful in applying the product)

Programming range

Voltage	20 mV - 51 V	20 mV - 51 V	10 mV - 20.4 V	25 mV - 61.2 V	10 mV - 20.4 V	25 mV - 61.2 V
Current	10 mA - 5.1 A	10 mA - 10.2 A	50 mA - 51 A	20 mA - 20.4 A	50 mA - 51 A	20 mA - 17.3 A

Programming resolution

Voltage	3.5 mV	3.5 mV	1.5 mV	4.2 mV	1.5 mV	4.2 mV
Current	3.25 mA	3.25 mA	16.3 mA	6.5 mA	16.3 mA	6.5 mA

Measurement resolution

Voltage	1.8 mV	1.8 mV	0.8 mV	2.2 mV	0.8 mV	2.2 mV
Current	410 µA	410 µA	2.05 mA	0.82 mA	2.05 mA	0.82 mA

Programming temperature coefficient per °C

Voltage	18 ppm + 160 µV	18 ppm + 160 µV	35 ppm + 100 µV	35 ppm + 170 µV	35 ppm + 100 µV	35 ppm + 170 µV
Current	100 ppm + 45 µA	100 ppm + 45 µA	60 ppm + 500 µA	60 ppm + 200 µA	60 ppm + 500 µA	60 ppm + 200 µA

Measurement temperature coefficient per °C

Voltage	25 ppm + 35 µV	25 ppm + 35 µV	50 ppm + 85 µV	50 ppm + 100 µV	50 ppm + 85 µV	50 ppm + 100 µV
Current	60 ppm + 3 µA	3 µA	30 µA	12 µA	30 µA	12 µA

N6705 mainframe oscilloscope measurement accuracy: (at 23°C ±5°C, accuracy of any individual point in the trace)

Voltage	0.05% + 32 mV	32 mV	15 mV	37 mV	15 mV	37 mV
Current - with correction on ¹	0.1% + 14 mA	0.1% + 14 mA	N/A	N/A	N/A	N/A
Current	0.1% + 8 mA	8 mA	52 mA	17 mA	52 mA	17 mA

Up-programming time with full resistive load: (Time from 10% to 90% of total voltage excursion)

Small voltage step	0 V to 10 V	0 V to 10 V	0 V to 6 V	0 V to 15 V	0 V to 10 V	0 V to 29 V
Time	0.2 ms	0.2 ms	0.4 ms	0.35 ms	0.5 ms	0.7 ms
Large voltage step	0 V to 50 V	0 V to 50 V	0 V to 20 V	0 V to 60 V	0 V to 20 V	0 V to 60 V
Time	1.5 ms	1.5 ms	1.5 ms	2 ms	1.5 ms	2 ms

Up-programming settling time with full resistive load: (Time from start of voltage change to within 0.1% of full scale value)

Small voltage step	0 V to 10 V	0 V to 10 V	0 V to 6 V	0 V to 15 V	0 V to 10 V	0 V to 29 V
Time	0.5 ms	0.5 ms	0.8 ms	0.8 ms	1.0 ms	1.4 ms
Large voltage step	0 V to 50 V	0 V to 50 V	0 V to 20 V	0 V to 60 V	0 V to 20 V	0 V to 60 V
Time	4 ms	4 ms	3 ms	4.2 ms	3 ms	4.2 ms

Down-programming time with no load: (Time from start of voltage change to output voltage <0.5 V)

Small voltage step	10 V to 0 V	10 V to 0 V	6 V to 0 V	15 V to 0 V	10 V to 0 V	29 V to 0 V
Time	0.3 ms	0.3 ms	0.55 ms	0.6 ms	1.0 ms	1.2 ms
Large voltage step	50 V to 0 V	50 V to 0 V	20 V to 0 V	60 V to 0 V	20 V to 0 V	60 V to 0 V
Time	1.3 ms	1.3 ms	1.8 ms	2.2 ms	1.8 ms	2.2 ms

¹ Correction On compensates for current flowing into the output capacitor during voltage transients

Low-Profile Modular Power System 20-300 W GPIB (Continued)

Specifications

(at 0° to 55°C, and derated above 40°C)

N6751A	N6752A	N6753A	N6754A	N6755A	N6756A
--------	--------	--------	--------	--------	--------

High-speed test extensions

To make your testing go even faster, the N6700 offers high-speed test extensions (HSTE) which comes standard on the N6760 and optional on the N6730/40/50/70 families. This enhancement to the N6700 DC power modules extends the capabilities to include features similar to a built-in arbitrary waveform generator and a built-in oscilloscope. Through the LIST mode of HSTE, you can download up to 512 setpoints of voltage and current. In LIST mode, you can program the output to execute a LIST of voltage and current setpoints. For each setpoint, a dwell time can be specified and the power supply will stay (i.e., dwell) at that setpoint for the programmed dwell time value.

The HSTE also provides an oscilloscope-like digitizer built into the power module to capture voltage and current measurements.

Power management feature allows you to allocate mainframe power

To further optimize your investment you may choose to save money configuring a system where the sum of the power modules installed in a mainframe exceeds the total power available from the mainframe. In this case, the new power management features of the N6700 allows you to allocate mainframe power to the outputs where it's needed and reduce power to the outputs where it is not needed, achieving maximum asset utilization and flexibility. This feature provides the safety from unexpected and dangerous shut-downs that can occur with power systems without power management when operated in a similar way.

Supplemental Characteristics

(Non-warranted characteristics determined by design that are useful in applying the product)

	N6751A	N6752A	N6753A	N6754A	N6755A	N6756A
Down-programming settling time with no load: (Time from start of voltage change to within 0.1% of full scale value)						
Small voltage step	10 V to 0 V	10 V to 0 V	6 V to 0 V	15 V to 0 V	10 V to 0 V	29 V to 0 V
Time	0.45 ms	0.45 ms	0.8 ms	0.8 ms	1.3 ms	1.5 ms
Large voltage step	50 V to 0 V	50 V to 0 V	20 V to 0 V	60 V to 0 V	20 V to 0 V	60 V to 0 V
Time	1.4 ms	1.4 ms	2 ms	2.3 ms	2 ms	2.3 ms
Down-programming time with capacitive load: (Time from start of voltage change to output voltage <0.5)						
Small voltage step	10 V to 0 V	10 V to 0 V	6 V to 0 V	15 V to 0 V	10 V to 0 V	29 V to 0 V
Time	2.1 ms	2.1 ms	2.2 ms	2.3 ms	4.5 ms	5.5 ms
Large voltage step	50 V to 0 V	50 V to 0 V	20 V to 0 V	60 V to 0 V	20 V to 0 V	60 V to 0 V
Time	11 ms	11 ms	8.5 ms	10 ms	8.5 ms	10 ms
Capacitive load ²	1000 µF	1000 µF	4700 µF	680 µF	4700 µF	680 µF
Down-programming capability						
Continuous power	7 W	7 W	12.5 W	12.5 W	12.5 W	12.5 W
Peak current	7 A	7 A	15 A	6 A	15 A	6 A
Over-voltage protection						
Accuracy	0.25% + 0.25 V	0.25 V	0.15 V	0.3 V	0.15 V	0.3 V
Accuracy w/option 761	0.25% + 0.25 V	0.25 V	0.45 V	0.6 V	0.45 V	0.6 V
Accuracy w/option 760	0.25% + N/A	N/A	0.45 V	0.6 V	0.45 V	0.6 V
Maximum setting	55 V	55 V	22 V	66 V	22 V	66 V
Response time	50 µs from occurrence of over-voltage condition to start of output shutdown					
Output ripple and noise: (PARD)						
CC rms	2 mA	2 mA	10 mA	4 mA	10 mA	4 mA
Common mode noise: (from 20 Hz - 20 MHz; from either output to chassis)						
Rms	500 µA	500 µA	500 µA	750 µA	500 µA	750 µA
Peak-to-peak	< 2 mA	< 2 mA	< 2 mA	< 3 mA	< 2 mA	< 3 mA
Remote sense capability: Outputs can maintain specifications with up to a 1 - volt drop per load lead. The load lead drop reduces the maximum available voltage at the load.						
Series and parallel operation: Identically rated outputs can be operated in parallel or be connected for straight series operation. Auto-series and auto-parallel operation is not available.						
Minimum output turn-on delay						
Without relay option	25 ms	25 ms	18 ms	18 ms	18 ms	18 ms
Without relay option 760	51 ms	51 ms	44 ms	44 ms	44 ms	44 ms

² Modules can discharge the specified capacitive load from full scale to 0 V at a rate of 4 times/second

Low-Profile Modular Power System 20-500 W GPIB (Continued)

Series and parallel operation

To increase the available power, identical models can be operated in series for greater output voltage or in parallel for greater output current.

To simplify parallel operation, the N6700 offers virtual channels, a firmware based feature that allows the N6700 system to treat up to 4 channels as a single, synchronized channel. Once configured, all functions (sourcing, measurements, triggering, protection, and status monitoring) behave as if there is 1 channel of up to 4 times the capacity of a single channel, without writing a single line of code to manage the interaction and synchronization of the paralleled power supplies.

Triggering

The N6700 MPS mainframe has hardware trigger in/trigger out signals which permit the N6700 to be synchronized with external events.

Output disconnect relays

Modules in the N6700 can be individually ordered with optional Output Disconnect Relays (option 761) or Output Disconnect/Polarity Reversal Relays (option 760). With option 761, Output Disconnect Relays, mechanical relays disconnect both the plus and minus side of the power supply, including the sense leads. With option 760, Output Disconnect/Polarity Reversal Relays switch the leads on both the plus and minus side of the power supply, including the sense leads, resulting in a voltage polarity reversal at the DUT.

Specifications

(at 0° to 55°C, and derated above 40°C)

DC output ratings

	N6761A	N6762A	N6763A	N6764A	N6765A	N6766A
Voltage	50 V	50 V	20 V	60 V	20 V	60 V
Current ¹	1.5 A	3 A	50 A	20 A	50 A	17 A
Power	50 W	100 W	300 W	300 W	500 W	500 W
Low programming ranges (V & I)	5.5 V; 100 mA	5.5 V; 100 mA	N/A	N/A	N/A	N/A
Low measurement ranges (V & I)	5.5 V; 100 mA	5.5 V; 100 mA	2 V; 1.5 A	6 V; 0.5 A	2 V; 1.5 A	6 V; 0.5 A

Programming accuracy

(at 23°C ±5°C after 30 minute warm-up. Applies from minimum to maximum programming range)

Voltage, high range	0.016% + 6 mV	0.016% + 6 mV	0.03% + 5 mV	0.03% + 12 mV	0.03% + 5 mV	0.03% + 12 mV
Voltage, low range	0.016% + 1.5 mV	0.016% + 1.5 mV	N/A	N/A	N/A	N/A
Current, high range	0.04% + 200 µA	0.04% + 200 µA	0.1% + 15 mA	0.075% + 4 mA	0.1% + 15 mA	0.075% + 4 mA
Current, low range	(@ 0-7 V) 0.04% + 30 µA	0.04% + 30 µA	N/A	N/A	N/A	N/A
	(@ 7-50 V) 0.04% + 55 µA	0.04% + 55 µA				

Voltmeter/ammeter measurement accuracy

(at 23°C ±5°C)

Voltage, high range	0.016% + 6 mV	0.016% + 6 mV	0.03% + 10 mV	0.03% + 25 mV	0.03% + 10 mV	0.03% + 25 mV
Voltage, low range	0.016% + 1.5 mV	0.016% + 1.5 mV	0.03% + 1.5 mV	0.03% + 5 mV	0.03% + 1.5 mV	0.03% + 5 mV
Current, high range	0.04% + 160 µA	0.04% + 160 µA	0.1% + 10 mA	0.1% + 5 mA	0.1% + 10 mA	0.1% + 5 mA
Current, low range	0.03% + 15 µA	0.03% + 15 µA	0.05% + 1.1 mA ³	0.05% + 0.75 mA ³	0.05% + 1.1 mA ³	0.05% + 0.75 mA ³
	(@ 0-7 V) ² 0.03% + 55 µA	0.03% + 55 µA				
	(@ 7-50 V)	(@ 7-50 V)				
200 µA current range (option 2UA)	0.5% + 100 nA	0.5% + 100 nA	N/A	N/A	N/A	N/A

Output ripple and noise (PARD): (from 20 Hz to 20 MHz)

CV peak-to-peak	4.5 mV	4.5 mV	5 mV	6 mV	5 mV	6 mV
CV rms	0.35 mV	0.35 mV	1 mV	1 mV	1 mV	1 mV

Load effect (Regulation): (Applies for any output load change, with a maximum load-lead drop of 1 V/ lead. The load lead drop reduces the maximum available voltage at the load.)

Voltage	0.5 mV	0.5 mV	2 mV	2 mV	2 mV	2 mV
Current	30 µA (@ 0-7 V)	30 µA (@ 0-7 V)	12 mA	5 mA	12 mA	5 mA
	65 µA (@ 7-50 V)	65 µA (@ 7-50 V)				

¹ Output current is derated 1% per °C above 40°C.

² Applies when measuring 4096 data points (SENSe:SWEp:POINts = 4096).

³ Applies when measuring currents that remain within the low range. Due to thermal settling, when transitioning from measuring full-rated output current (the worst case), to measuring the current within the low range, the low range accuracy specification is typically met within 5 seconds after the current has transitioned into the low range. Accuracies within this 5 second settling period are typically 2X the specified accuracy or better.

More detailed specifications at www.agilent.com/find/N6700

Low-Profile Modular Power System 20-500 W GPIB (Continued)

Universal AC input

The N6700 has a universal input that operates from 100-240 VAC, 50/60/400 Hz. There are no switches to set or fuses to change when switching from one voltage standard to another. The AC input employs power factor correction.

Choosing the Right DC Power Modules to Meet Your ATE Needs

DC power supply modules for the N6700 system are available in Basic, High-Performance and Precision models. Basic DC power modules provide programmable voltage and current, measurement and protection features at a very economical price, making these modules suitable to power the DUT or to provide power for ATE system resources such as fixture control. High-Performance, DC power modules provide low noise, high accuracy and programming speeds that are up to 10 to 50 times faster than other programmable power supplies. Precision DC power modules provide precise control and measurements in the milliampere and microampere region with the ability to simultaneously digitize voltage and current, and capture those measurements in an oscilloscope-like data buffer.

Modules with autoranging output capability that extends the available voltage or current range while staying within a module's power rating, enables one power supply to do the job of several traditional power supplies.

Specifications

(at 0° to 55°C, and derated above 40°C)

Source effect (Regulation)

	N6761A	N6762A	N6763A	N6764A	N6765A	N6766A
Voltage	0.5 mV	0.5 mV	0.5 mV	1.2 mV	0.5 mV	1.2 mV
Current	30 µA	30 µA	5 mA	2 mA	5 mA	2 mA

Load transient recovery time

Time to recover to within the settling band following a load change

- from 60% to 100% and from 100% to 60% of full load for model N6761A

- from 50% to 100% and from 100% to 50% of full load for model N6762A though N6766A)

	N6761A	N6762A	N6763A	N6764A	N6765A	N6766A
Voltage settling band	± 75 mV	± 75 mV	± 30 mV ⁴	± 90 mV ⁵	± 30 mV ⁴	± 90 mV ⁵
Time	< 100 µs	< 100 µs	< 100 µs	< 100 µs	< 100 µs	< 100 µs

Supplemental Characteristics

(Non-warranted characteristics determined by design that are useful in applying the product)

Programming range

	N6761A	N6762A	N6763A	N6764A	N6765A	N6766A
Voltage, high range	15 mV - 51 V	15 mV - 51 V	10 mV - 20.4 V	25 mV - 61.2 V	10 mV - 20.4 V	25 mV - 61.2 V
Voltage, low range	12 mV - 5.5 V	12 mV - 5.5 V	N/A	N/A	N/A	N/A
Current, high range	1 mA - 1.53 A	1 mA - 3.06 A	50 mA - 51 A	20 mA - 20.4 A	50 mA - 51 A	20 mA - 17.3 A
Current, low range	0.1 mA - 0.1 A ⁶	0.1 mA - 0.1 A ⁶	N/A	N/A	N/A	N/A

Programming resolution

	N6761A	N6762A	N6763A	N6764A	N6765A	N6766A
Voltage, high range	880 µV	880 µV	1.5 mV	4.2 mV	1.5 mV	4.2 mV
Voltage, low range	90 µV	90 µV	N/A	N/A	N/A	N/A
Current, high range	60 µA	60 µA	16.3 mA	6.5 mA	16.3 mA	6.5 mA
Current, low range	2 µA	2 µA	N/A	N/A	N/A	N/A

Measurement resolution

	N6761A	N6762A	N6763A	N6764A	N6765A	N6766A
Voltage, high range	440 µV	440 µV	250 µV	600 µV	250 µV	600 µV
Voltage, low range	44 µV	44 µV	25 µV	60 µV	25 µV	60 µV
Current, high range	30 µA	30 µA	500 µA	250 µA	500 µA	250 µA
Current, low range	1 µA	1 µA	20 µA	10 µA	20 µV	10 µA
200 µA current range (Option 2UA)	4 nA	4 nA	N/A	N/A	N/A	N/A

Programming temperature coefficient per °C

	N6761A	N6762A	N6763A	N6764A	N6765A	N6766A
Voltage, high range	18 ppm + 140 µV	18 ppm + 140 µV	23 ppm + 95 µV	23 ppm + 218 µV	23 ppm + 95 µV	23 ppm + 218 µV
Voltage, low range	40 ppm + 70 µV	40 ppm + 70 µV	N/A	N/A	N/A	N/A
Current, high range	33 ppm + 10 µA	33 ppm + 10 µA	25 ppm + 129 µA	25 ppm + 52 µA	25 ppm + 129 µA	25 ppm + 52 µA
Current, low range	60 ppm + 1.5 µA	60 ppm + 1.5 µA	N/A	N/A	N/A	N/A

⁴ When relay option 760 or 761 is installed on Model N6763A and N6765A, the settling band is ± 200 mV.

⁵ When relay option 760 or 761 is installed on Model N6764A and N6766A, the settling band is ± 350 mV.

⁶ If you are operating the unit below 255 µA in constant current mode, the output may become unregulated with the following load conditions: The load resistance is <175 mΩ and the load inductance is > 20 µH. If this occurs, an UNRegulated flag will be generated and the output current may rise above the programmed value but will remain less than 255 µA.

Low-Profile Modular Power System 20-500 W GPIB (Continued)

Specifications

(at 0° to 55°C, and derated above 40°C)

N6761A N6762A N6763A N6764A N6765A N6766A

N6750 family

The Agilent N6750 family of high-performance, autoranging DC power modules provides low noise, high accuracy and includes, auto-ranging output capabilities enabling one power supply to do the job of several traditional power supplies.

N6760 family

The Agilent N6760 family of precision DC power modules provides precise control and measurements in the milliamper and microampere region with the ability to simultaneously digitize voltage and current, and capture those measurements in an oscilloscope-like data buffer. The N6761A/N6762A precision DC power modules offer dual ranges on both programming and measurement while the N6763A-N6766A offer dual measurement ranges. All are ideally suited for semiconductor and passive device testing.

N6750/60 low noise outputs

This switching power supply outperforms most linear power supplies on the market with low normal and common mode noise.

Supplemental Characteristics

(Non-warranted characteristics determined by design that are useful in applying the product)

Measurement temperature coefficient per °C

Voltage, high range	23 ppm + 40 µV	23 ppm + 40 µV	23 ppm + 53 µV	23 ppm + 73 µV	23 ppm + 53 µV	23 ppm + 73 µV
Voltage, low range	30 ppm + 40 µV	30 ppm + 40 µV	25 ppm + 53 µV	25 ppm + 73 µV	25 ppm + 53 µV	25 ppm + 73 µV
Current, high range	40 ppm + 0.3 µA	40 ppm + 0.3 µA	25 ppm + 21 µA	25 ppm + 7 µA	25 ppm + 21 µA	25 ppm + 7 µA
Current, low range	50 ppm + 0.3 µA	50 ppm + 0.3 µA	27 ppm + 21 µA	27 ppm + 7 µA	27 ppm + 21 µA	27 ppm + 7 µA
200 µA current range (option 2UA)	100 ppm + 3 nA/°C	100 ppm + 3 nA/°C	N/A	N/A	N/A	N/A

N6705 mainframe oscilloscope measurement accuracy: (at 23°C ±5°C, accuracy of any individual point in the trace)

Voltage	0.016% + 16 mV	0.016% + 16 mV	0.03% + 13 mV	0.03% + 32 mV	0.03% + 13 mV	0.03% + 32 mV
Current, high range (with Correction On ¹)	0.04% + 10 mA	0.04% + 10 mA	N/A	N/A	N/A	N/A
Current, high range	0.04% + 1 mA	0.04% + 1 mA	0.1% + 16 mA	0.1% + 8.4 mA	0.1% + 16 mA	0.1% + 8.4 mA
Current, low range	0.03% + 0.175 mA	0.03% + 0.175 mA	0.05% + 6.6 mA	0.05% + 2.6 mA	0.05% + 6.6 mA	0.05% + 2.6 mA

Up-programming time with full resistive load: (time from 10% to 90% of total voltage excursion)

Small voltage step	0 V to 10 V	0 V to 10 V	0 V to 6 V	0 V to 15 V	0 V to 10 V	0 V to 29 V
Time	0.6 ms	0.6 ms	0.4 ms	0.35 ms	0.5 ms	0.7 ms
Large voltage step	0 V to 50 V	0 V to 50 V	0 V to 20 V	0 V to 60 V	0 V to 20 V	0 V to 60 V
Time	2.2 ms	2.2 ms	1.5 ms	2 ms	1.5 ms	2 ms

Up-programming settling time with full resistive load: (time from start of voltage change to within 0.1% of full scale value)

Small voltage step	0 V to 10 V	0 V to 10 V	0 V to 6 V	0 V to 15 V	0 V to 10 V	0 V to 29 V
Time	0.9 ms	0.9 ms	0.8 ms	0.8 ms	1.0 ms	1.4 ms
Large voltage step	0 V to 50 V	0 V to 50 V	0 V to 20 V	0 V to 60 V	0 V to 20 V	0 V to 60 V
Time	4 ms	4 ms	3 ms	4.2 ms	3 ms	4.2 ms

Down-programming time with no load: (time from start of voltage change to output voltage <0.5 V)

Small voltage step	10 V to 0 V	10 V to 0 V	6 V to 0 V	15 V to 0 V	10 V to 0 V	29 V to 0 V
Time	0.3 ms	0.3 ms	0.55 ms	0.6 ms	1.0 ms	1.2 ms
Large voltage step	50 V to 0 V	50 V to 0 V	20 V to 0 V	60 V to 0 V	20 V to 0 V	60 V to 0 V
Time	1.3 ms	1.3 ms	1.8 ms	2.2 ms	1.8 ms	2.2 ms

Down-programming setting time with no load: (time from start of voltage change to within 0.1% of full scale value)

Small voltage step	10 V to 0 V	10 V to 0 V	6 V to 0 V	15 V to 0 V	10 V to 0 V	29 V to 0 V
Time	0.45 ms	0.45 ms	0.8 ms	0.8 ms	1.3 ms	1.5 ms
Large voltage step	50 V to 0 V	50 V to 0 V	20 V to 0 V	60 V to 0 V	20 V to 0 V	60 V to 0 V
Time	1.4 ms	1.4 ms	2 ms	2.3 ms	2 ms	2.3 ms

¹ Correction On compensates for current flowing into the output capacitor during voltage transients

Low-Profile Modular Power System 20-500 W GPIB (Continued)

Specifications

(at 0° to 55°C, and derated above 40°C)

N6761A	N6762A	N6763A	N6764A	N6765A	N6766A
--------	--------	--------	--------	--------	--------

N6750/60 output programming speed

The N6750/60 achieves performance unlike a typical DC power supply with up to 10 to 50 times faster than other programmable power supplies. Thanks to an active down-programming circuit to rapidly pull down the output when lowering the module's output voltage, the N6750/60 can rapidly program both up and down in voltage. These output speeds allow the N6750/60 to give maximum system throughput when your test calls for frequent changes in power supply voltage settings.

N6750/60 autoranging for flexibility

The N6750/60 gives test system designers even more flexibility by providing autoranging outputs. This autoranging capability provides maximum output power at any output voltage up to 50 V. This allows one power supply to do the job of several power supplies because its operating range covers low voltage, high current as well as high voltage, low current operating points.

Supplemental Characteristics

(Non-warranted characteristics determined by design that are useful in applying the product)

Down-programming time with capacitive load: (time from start of voltage change to output voltage <0.5 V)						
Small voltage step	10 V to 0 V	10 V to 0 V	6 V to 0 V	15 V to 0 V	10 V to 0 V	29 V to 0 V
Time	4.5 ms	4.5 ms	2.2 ms	2.3 ms	4.5 ms	5.5 ms
Large voltage step	50 V to 0 V	50 V to 0 V	20 V to 0 V	60 V to 0 V	20 V to 0 V	60 V to 0 V
Time	23 ms	23 ms	8.5 ms	10 ms	8.5 ms	10 ms
Capacitive load ²	1000 µF	1000 µF	4700 µF	680 µF	4700 µF	680 µF
Down-programming capability						
Continuous power	7 W	7 W	12.5 W	12.5 W	12.5 W	12.5 W
Peak current	3.8 A	3.8 A	15 A	6 A	15 A	6 A
Over-voltage protection						
Accuracy	0.25% + 0.25 V	0.25 V	0.15 V	0.3 V	0.15 V	0.3 V
Accuracy w/option 761	0.25% + 0.25 V	0.25 V	0.45 V	0.6 V	0.45 V	0.6 V
Accuracy w/option 760	0.25% + N/A	N/A	0.45 V	0.6 V	0.45 V	0.6 V
Maximum setting	55 V	55 V	22 V	66 V	22 V	66 V
Response time	50 µs from occurrence of over-voltage condition to start of output shutdown					
Output ripple and noise: (PARD)						
CC rms	2 mA	2 mA	10 mA	4 mA	10 mA	4 mA
Common mode noise: (from 20 Hz to 20 MHz; from either output to chassis)						
Rms	500 µA	500 µA	500 µA	750 µA	500 µA	750 µA
Peak-to-peak	<2 mA	<2 mA	<2 mA	<3 mA	<2 mA	<3 mA
Remote sense capability: Outputs can maintain specifications with up to a 1 - volt drop per load lead. The load lead drop reduces the maximum available voltage at the load.						
Series and parallel operation: Identically rated outputs can be operated in parallel or be connected for straight series operation. Auto-series and auto-parallel operation is not available.						
Minimum output turn-on delay: Time from when any Output On command is received until the output starts turning on.						
Without relay option	32 ms ³	32 ms ³	18 ms	18 ms	18 ms	18 ms
Without relay option 760	58 ms ³	58 ms ³	44 ms	44 ms	44 ms	44 ms

² Modules can discharge the specified capacitive load from full scale to 0 V at a rate of 4 times/second.

³ In Current priority mode, minimum delay is 23 ms without relays and 45 ms with relay Option 760.

Low-Profile Modular Power System 20-500 W GPIB (Continued)

N6730/40/70 family

The Agilent N6730, N6740, and N6770 families of DC power modules provide programmable voltage and current, measurement and protection features at a very economical price, making these modules suitable to power the DUT or to provide power for ATE system resources, such as fixture control. The N6730/40/70 families give you clean, reliable DC power without advanced features, plus gives you the added benefits of being a part of the N6700 MPS including small size (true 1U), mix-and-match with other N6700 DC power modules when you need performance along with basic DC outputs, connectivity via LAN, USB, and GPIB, and fast command processing time of less than 1 ms.

See Application Specific DC Power Supplies section for additional models
Mobile Communications
DC Sources page 122

Source Measure Units page 137

N6781A 2-quadrant source measure unit for battery drain analysis

The N6781A offers the features required to accurately capture the power consumption of portable, battery-powered devices. When used with the new Agilent 14585A software, the N6781A becomes an even more powerful battery drain analysis solution offering greater measurement insight.

Specifications (at 0° to 55°C, and derated above 40°C)	N6773A	N6774A	N6775A	N6776A	N6777A
DC output ratings					
Voltage	20 V	35 V	60 V	100 V	150 V
Current ¹	15 A ²	8.5 A	5 A	3 A	2 A
Power	300 W	300 W	300 W	300 W	300 W
Programming accuracy: (at 25°C ±5°C after 30 minute warm-up. Applies from minimum to maximum programming range)					
Voltage	0.1% + 20 mV	35 mV	60 mV	100 mV	150 mV
Current	0.15% + 60 mA	60 mA	60 mA	30 mA	30 mA
Voltmeter/ammeter measurement accuracy: (at 25°C ±5°C)					
Voltage	0.1% + 20 mV	35 mV	60 mV	100 mV	150 mV
Current	0.15% + 15 mA	12 mA	12 mA	6 mA	6 mA
Output ripple and noise (PAR): (from 20 Hz to 20 MHz)					
CV peak-to-peak	20 mV	22 mV	35 mV	45 mV	68 mV
CV rms	3 mV	5 mV	9 mV	18 mV	27 mV
Load effect (Regulation): (Applies for any output load change, with a maximum load-lead drop of 1 V/lead. The load lead drop reduces the maximum available voltage at the load.)					
Voltage	13 mV	16 mV	24 mV	45 mV	68 mV
Current	6 mA	6 mA	6 mA	6 mA	6 mA
Source effect (Regulation)					
Voltage	2 mV	4 mV	6 mV	10 mV	15 mV
Current	1 mA	1 mA	1 mA	1 mA	1 mA
Load transient recovery time: (Time to recover to within the settling band following a load change from 50% to 100% and from 100% to 50% of full load.)					
Voltage settling time	±0.3 V ³	±0.3 V ³	±0.5 V	±1.0 V	±2.0 V
Time	<250 μs	<250 μs	<250 μs	<250 μs	<250 μs
Supplemental Characteristics (Non-warranted characteristics determined by design that are useful in applying the product)					
Programming ranges					
Voltage	30 mV - 20.4 V	40 mV - 35.7 V	70 mV - 61.2 V	100 mV - 102 V	145 mV - 153 V
Current	30 mA - 15.3 A	15 mA - 8.67 A	7.5 mA - 5.1 A	4.5 mA - 3.06 A	2.75 mA - 2.04 A
Programming resolution					
Voltage	7 mV	10 mV	18 mV	28 mV	43 mV
Current	9 mA	6 mA	3 mA	1.5 mA	1 mA
Measurement resolution					
Voltage	10 mV	18 mV	30 mV	50 mV	77 mV
Current	9 mA	6 mA	3 mA	1.5 mA	1 mA

¹ Output current is derated 1% per °C above 40 °C.

² When relay option 760 is installed in Model N6773A, the output current is limited to 10 A.

³ When relay option 760 or 761 is installed, the settling band is ±0.35 V.

Low-Profile Modular Power System 20-500 W GPIB (Continued)

Specifications

(at 0° to 55°C, and derated above 40°C)

N6773A N6774A N6775A N6776A N6777A

N6782A 2-quadrant source measure unit for functional test

The N6782A can modulate its output up to 100 kHz and provides 2-quadrant operation. This makes the SMU a perfect fit for advanced functional test of a variety of devices including DC/DC converters, power management units, and power amplifiers.

N6784A 4-quadrant source measure unit

The N6784A provides precise sourcing and measurement for your general purpose needs.

Supplemental characteristics for all model numbers

DC floating voltage: Output terminals can be floated up to ±240 VDC from chassis ground

Remote sensing: Output can maintain specifications with up to 1-volt drop per load lead

Command processing time: Average time required for the output voltage to begin to change following receipt of digital data is ≤ 1ms.

High speed test extentions:

List mode:

- Number of steps = 1 to 512
- Dwell time = 1 to 262 s
- Maximum list repetitions = 256 or infinite

Supplemental Characteristics

(Non-warranted characteristics determined by design that are useful in applying the product)

Programming temperature coefficient per °C		N6773A	N6774A	N6775A	N6776A	N6777A
Voltage	0.01% +	0.2 mV	0.5 mV	0.5 mV	1 mV	1 mV
Current	0.01% +	0.5 mA	0.5 mA	0.1 mA	0.1 mA	0.1 mA
Measurement temperature coefficient per °C		N6773A	N6774A	N6775A	N6776A	N6777A
Voltage	0.01% +	0.2 mV	0.2 mV	0.5 mV	0.5 mV	0.5 mV
Current	0.01% +	0.5 mA	0.5 mA	0.05 mA	0.05 mA	0.05 mA
N6705 mainframe oscilloscope measurement accuracy: (at 25°C ±5°C, accuracy of any individual point in the trace)						
Voltage	0.1% +	45 mV	75 mV	120 mV	160 mV	175 mV
Current - with Correction On ¹	0.15% +	35 mA	22 mA	19 mA	9 mA	9 mA
Current	0.15% +	45 mA	27 mA	22 mA	12 mA	12 mA
Up-programming and down-programming time with full resistive load: (Time from 10% to 90% of total voltage excursion; for voltage setting from 0 V to full scale and full scale to 0 V)						
Time		20 ms	20 ms	20 ms	20 ms	20 ms
Maximum up-programming and down-programming settling time with full resistive load: (Time from start of voltage change to within 0.1% of full scale value; for voltage setting from 0 V to full scale and full scale to 0 V)						
Time		100 ms	100 ms	100 ms	100 ms	100 ms
Over-voltage protection:						
Accuracy	0.25% +	100 mV	130 mV	260 mV	650 mV	650 mV
Accuracy w/opt. 761	0.25% +	500 mV	350 mV	350 mV	650 mV	650 mV
Accuracy w/opt. 760	0.25% +	700 mV	700 mV	400 mV	650 mV	650 mV
Maximum setting		22 V	38.5 V	66 V	110 V	165 V
Response time (50 μs from occurrence of over-voltage condition to start of output shutdown)						
Output ripple and noise (PAR)						
CC rms		6 mA	6 mA	6 mA	6 mA	6 mA
Common mode noise: (from 20 Hz - 20 MHz; from either output to chassis)						
Rms		2 mA	2 mA	2 mA	2 mA	2 mA
Peak-to-peak		< 20 mA	< 20 mA	< 20 mA	< 20 mA	< 20 mA
Remote sense capability: Output can maintain specifications with up to a 1 volt drop per load lead. The load lead drop reduces the maximum available voltage at the load.						
Series and parallel operation: Identically rated outputs can be operated directly in parallel or can be connected for straight series operation. Auto series and auto-parallel operation is not available.						
Minimum output turn-on delay: Time from when any Output On command is received until the output starts turning on.						
Without relay option		32 ms	32 ms	32 ms	32 ms	32 ms
With relay option 760		58 ms	58 ms	58 ms	58 ms	58 ms

¹ Correction On compensates for current flowing into the output capacitor during voltage transients

Low-Profile Modular Power System 20-300 W GPIB (Continued)

Digitizer:

- Measurement points = 1 to 512 K
- Sample rate = 0.000025 Hz up to 200 kHz

I/O interface:

GPIB, LAN, USB standard

Software driver:

- IVI-COM
- VXIPlug&Play

AC input:

- Input ratings: 100 – 240 VAC; 50/60/400 Hz
- Power consumption:
 - N6700B–1440 VA typical (with power factor correction)
 - N6701A–1440 VA typical (with power factor correction)
 - N6702A–1440 VA typical @ < 180 VAC input (with power factor correction)
 - N6702A–2200 VA typical @ > 180 VAC input (with power factor correction)

Regulatory compliance: European EMC directive 89/336/EEC for Class A products, Australian C-Tick mark, This ISM device complies with Canadian ICES-001. Cet appareil ISM est conforme à la norme NMB-001 du Canada. European Low Voltage Directive 73/23/EEC.

Size:

- Height 44.45 mm; 1.75 in
- Width 432.5 mm; 17.03 in
- Depth (including handles) 585.6 mm; 23.06 in (N6700B/N6701A) 633.9 mm; 24.96 in (N6702A)

Specifications

(at 0° to 55°C, and derated above 40°C)

Output ratings

	N6731B	N6732B	N6733B	N6734B	N6735B	N6736B
Voltage	5 V	8 V	20 V	35 V	60 V	100 V
Current	10 A	6.25 A	2.5 A	1.5 A	0.8 A	0.5 A
Power	50 W	50 W	50 W	50 W	50 W	50 W

Programming accuracy²
(at 23°C ±5°C)

	N6731B	N6732B	N6733B	N6734B	N6735B	N6736B
Voltage	0.1% + 19 mV	0.1% + 19 mV	0.1% + 20 mV	0.1% + 35 mV	0.1% + 60 mV	0.1% + 100 mV
Current	0.15% + 20 mA	0.15% + 20 mA	0.15% + 20 mA	0.15% + 20 mA	0.15% + 20 mA	0.15% + 10 mA

Readback accuracy (at 23°C ±5°C)

	N6731B	N6732B	N6733B	N6734B	N6735B	N6736B
Voltage	0.1% + 20 mV	0.1% + 20 mV	0.1% + 20 mV	0.1% + 35 mV	0.1% + 60 mV	0.1% + 100 mV
Current	0.15% + 20 mA	0.15% + 10 mA	0.15% + 5 mA	0.15% + 4 mA	0.15% + 4 mA	0.15% + 2 mA

Output ripple and noise (PAR)
(from 20 Hz – 20 MHz)

	N6731B	N6732B	N6733B	N6734B	N6735B	N6736B
CV peak-to-peak	10 mV	12 mV	14 mV	15 mV	25 mV	30 mV
CV rms	2 mV	2 mV	3 mV	5 mV	9 mV	18 mV

Load regulation¹

	N6731B	N6732B	N6733B	N6734B	N6735B	N6736B
Voltage	5 mV	6 mV	9 mV	11 mV	13 mV	20 mV
Current	2 mA	2 mA	2 mA	2 mA	2 mA	2 mA

Line regulation

	N6731B	N6732B	N6733B	N6734B	N6735B	N6736B
Voltage	1 mV	2 mV	2 mV	4 mV	6 mV	10 mV
Current	1 mA	1 mA	1 mA	1 mA	1 mA	1 mA

Transient response time (time to recover to within the settling band following a load change from 50% to 100% and from 100% to 50% of full load.)

	N6731B	N6732B	N6733B	N6734B	N6735B	N6736B
Voltage settling band	± 80 mV	± 80 mV	± 200 mV	± 200 mV	± 400 mV	± 500 mV
Time	200 μs	200 μs	200 μs	200 μs	200 μs	200 μs

¹ With an output change from no load to full load, up to a maximum load-lead drop of 1 V per lead.

² Applies from minimum to maximum programming range. (see Supplemental Characteristics)

Low-Profile Modular Power System 20-300 W GPIB (Continued)

Specifications

(at 0° to 55°C, and derated above 40°C)

N6731B	N6732B	N6733B	N6734B	N6735B	N6736B
--------	--------	--------	--------	--------	--------

Weight:

- N6700B with 4 installed modules
Net: 12.73 kg; 28 lbs.
- N6701A with 4 installed modules
Net: 11.82 kg; 26 lbs.
- N6702A with 4 installed modules
Net: 14.09 kg; 31 lbs.
- Single power module
Net: 1.23 kg; 2.71 lbs.

Warranty:

Three years

Supplemental Characteristics

(Non-warranted characteristics determined by design that are useful in applying the product)

	N6731B	N6732B	N6733B	N6734B	N6735B	N6736B
Programming resolution						
Voltage	3.5 mV	4 mV	7 mV	10 mV	18 mV	28 mV
Current	7 mA	4 mA	3 mA	2 mA	1 mA	0.5 mA
Output ripple and noise (PAR)						
CC rms	8 mA	4 mA	2 mA	2 mA	2 mA	2 mA
Over-voltage protection						
Accuracy (without relay option)	0.25% + 50 mV	0.25% + 50 mV	0.25% + 75 mV	0.25% + 100 mV	0.25% + 200 mV	0.25% + 250 mV
Response time	50 μs from occurrence of 0 V condition to start of output shutdown					
Maximum up-programming and down-programming time with full resistive load: (time from 10% to 90% of total voltage excursion)						
Voltage setting from 0 V to full scale and full scale to 0 V	20 ms	20 ms	20 ms	20 ms	20 ms	20 ms
Maximum up-programming and down-programming settling time with full resistive load: (time from start of voltage change until voltage settles within 0.1% of the full-scale voltage of its final value)						
Voltage setting from 0 V to full scale and full scale to 0 V	100 ms	100 ms	100 ms	100 ms	100 ms	100 ms

Low-Profile Modular Power System 20-300 W GPIB (Continued)

Specifications (at 0° to 55°C, and derated above 40°C)	N6741B	N6742B	N6743B	N6744B	N6745B	N6746B
Output ratings						
Voltage	5 V	8 V	20 V	35 V	60 V	100 V
Current	20 A	12.5 A	5 A	3 A	1.6 A	1 A
Power	100 W	100 W	100 W	100 W	100 W	100 W
Programming accuracy² (at 23°C ±5°C)						
Voltage	0.1% + 19 mV	0.1% + 19 mV	0.1% + 20 mV	0.1% + 35 mV	0.1% + 60 mV	0.1% + 100 mV
Current	0.15% + 20 mA	0.15% + 20 mA	0.15% + 20 mA	0.15% + 20 mA	0.15% + 20 mA	0.15% + 10 mA
Readback accuracy (at 23°C ±5°C)						
Voltage	0.1% + 20 mV	0.1% + 20 mV	0.1% + 20 mV	0.1% + 35 mV	0.1% + 60 mV	0.1% + 100 mV
Current	0.15% + 20 mA	0.15% + 10 mA	0.15% + 5 mA	0.15% + 4 mA	0.15% + 4 mA	0.15% + 2 mA
Output ripple and noise (PAR) (from 20 Hz – 20 MHz)						
CV peak-to-peak	11 mV	12 mV	14 mV	15 mV	25 mV	30 mV
CV rms	2 mV	2 mV	3 mV	5 mV	9 mV	18 mV
Load regulation¹						
Voltage	5 mV	6 mV	9 mV	11 mV	16 mV	30 mV
Current	2 mA	2 mA	2 mA	2 mA	2 mA	2 mA
Line regulation						
Voltage	1 mV	2 mV	2 mV	4 mV	6 mV	10 mV
Current	1 mA	1 mA	1 mA	1 mA	1 mA	1 mA
Transient response time (time to recover to within the settling band following a load change from 50% to 100% and from 100% to 50% of full load.)						
Voltage settling band	± 100 mV	± 100 mV	± 300 mV	± 300 mV	± 500 mV	± 1000 mV
Time	200 µs	200 µs	200 µs	200 µs	200 µs	200 µs
Programming resolution						
Voltage	3.5 mV	4 mV	7 mV	10 mV	18 mV	28 mV
Current	7 mA	4 mA	3 mA	2 mA	1 mA	0.5 mA
Output ripple and noise (PAR)						
CC rms	8 mA	4 mA	2 mA	2 mA	2 mA	2 mA
Over-voltage protection						
Accuracy (without relay option)	0.25% + 50 mV	0.25% + 50 mV	0.25% + 75 mV	0.25% + 100 mV	0.25% + 200 mV	0.25% + 250 mV
Response time	50 µs from occurrence of 0 V condition to start of output shutdown					
Maximum up-programming and down-programming time with full resistive load: (time from 10% to 90% of total voltage excursion)						
Voltage setting from 0 V to full scale and full scale to 0 V	20 ms	20 ms	20 ms	20 ms	20 ms	20 ms
Maximum up-programming and down-programming settling time with full resistive load: (time from start of voltage change until voltage settles within 0.1% of the full-scale voltage of its final value)						
Voltage setting from 0 V to full scale and full scale to 0 V	100 ms	100 ms	100 ms	100 ms	100 ms	100 ms

¹ With an output change from no load to full load, up to a maximum load-lead drop of 1 V per lead.

² Applies from minimum to maximum programming range. (see Supplemental Characteristics)

Low-Profile Modular Power System 20-300 W GPIB (Continued)

Specifications

(at 0° to 55°C, and derated above 40°C)

N6700B

N6701A

N6702A

Supplemental Characteristics

(Non-warranted characteristics determined by design and useful in applying the product)

Maximum total output power
(= Sum of total module output power)

	N6700B	N6701A	N6702A
	400 W when operating from 100 -240 VAC input	600 W when operating from 100 -240 VAC input	1200 W when operating from 200 -240 VAC input
			600 W when operating from 100 -120 VAC input

Ordering information

Options for N6700 mainframes

- Opt FLR** Filler panel kit
- Opt 0L1** English printed users guide (full documentation on CD-ROM)
- Opt 900** Power cord, United Kingdom
- Opt 901** Power cord, Australia
- Opt 902** Power cord, Europe
- Opt 903** Power cord, USA, Canada, 120 V
- Opt 904** Power cord, USA, Canada, 240 V
- Opt 906** Power cord, Switzerland
- Opt 912** Power cord, Denmark
- Opt 917** Power cord, South Africa, India
- Opt 918** Power cord, Japan
- Opt 919** Power cord, Israel
- Opt 920** Power cord, Argentina
- Opt 921** Power cord, Chile
- Opt 922** Power cord, China
- Opt 927** Power cord, Thailand

Accessories for N6700 mainframes

- N6709A** Rack mount kit
Required for rack mounting of N6700B, N6701A, N6702A. (Standard rack mount hardware will not work)
- N6708A** Filler panel kit
Required when you have < 4 modules in an N6700B, N6701A, or N6702A. Each filler panel kit contains 3 filler panels.

Options for modules

- Opt 760** Open/close and polarity reverse relays (only available at time of order on models N6731B-N6736B, N6742B-N6746B, N6773A-N6776A)
- Opt 761** Output disconnect relays (only available at time of order)
- Opt UK6** Commercial calibration with test result data
- Opt 1A7** ISO 17025 Cal Certificate
- Opt 054** High-Speed Test Extension N673x, 4x, 5x, 7x. Comes standard on the N676x and N678x.

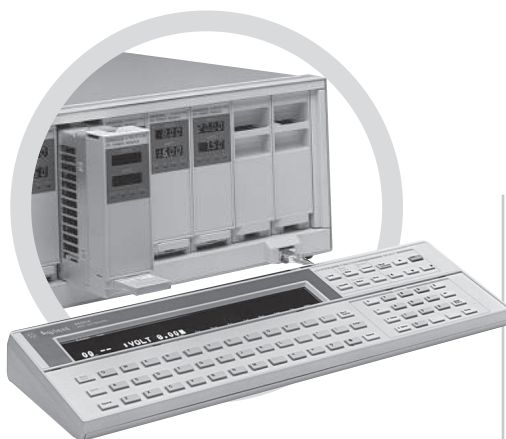

Modular Power System 1200 W per mainframe GPIB

- Modular system permits up to 8 outputs of 150 W per output in 4U of rack space
- Reconfigure fast with easily swappable modules
- Fast, low-noise outputs
- LIST mode and advance triggering system
- Optional isolation and polarity reversal relays
- Built-in measurements and advanced programmable features
- Protection features to ensure DUT safety

66000A (mainframe)
66001A (keyboard)

Specifications

(at 0° to 55°C unless otherwise specified)

66101A 66102A 66103A 66104A 66105A 66106A

66000 Modular Power System

The Agilent 66000 modular power system simplifies test-system assembly, cabling, programming, debugging and operation. It is ideal for ATE and production test environments, where it can supply bias power and stimulus to sub-assemblies and final products. The modular power system saves rack space, the 7-inch-high (4-EIA units) mainframe can accommodate up to eight DC power modules.

Key features

- GPIB-programmable voltage and current
- Programmable over-voltage and over-current protection
- Self-test initiated at power-up or from GPIB command
- Electronic calibration over GPIB or from keyboard
- Over-temperature protection
- Discrete fault indicator/remote inhibit (DFI/RI)
- Five nonvolatile store-recall states per output
- User-definable power-on state

Multiple Mainframes at One GPIB Address

The Agilent serial link feature will allow you to control up to 16 outputs at one GPIB address by connecting an auxiliary mainframe. The serial link cable comes standard with the

Output ratings at 40°C

Output voltage	0 to 8 V	0 to 20 V	0 to 35 V	0 to 60 V	0 to 120 V	0 to 200 V
Output current	0 to 16 A	0 to 7.5 A	0 to 4.5 A	0 to 2.5 A	0 to 1.25 A	0 to 0.75 A
Maximum power	128 W	150 W	150 W	150 W	150 W	150 W

Programming accuracy at 25°C ±5°C

Voltage	0.03% +	3 mV	8 mV	13 mV	27 mV	54 mV	90 mV
Current	0.03% +	6 mA	3 mA	2 mA	1.2 mA	0.6 mA	0.4 mA

Readback accuracy

(via GPIB or keyboard display at 25°C ±5°C)

Voltage	0.02%+	2 mV	5 mV	8 mV	16 mV	32 mV	54 mV
Current	0.02%+	6 mA	3 mA	2 mA	1 mA	0.6 mA	0.3 mA

Ripple and noise (20 Hz to 20 MHz)

Constant voltage rms	2 mV	3 mV	5 mV	9 mV	18 mV	30 mV
peak-peak	5 mV	7 mV	10 mV	15 mV	25 mV	50 mV
Constant current rms	8 mA	4 mA	2 mA	1 mA	1 mA	1 mA

Line regulation

Voltage	0.5 mV	0.5 mV	1 mV	2 mV	3 mV	5 mV
Current	0.75 mA	0.5 mA	0.3 mA	0.1 mA	50 µA	30 µA

Load regulation

Voltage	1 mV	1 mV	1 mV	2 mV	4 mV	7 mV
Current	0.5 mA	0.2 mA	0.2 mA	0.1 mA	50 µA	30 µA

Transient response time

Less than 1 ms for the output voltage to recover within 100 mV of its previous level following any step change in load current up to 10 percent of rated current

Supplemental Characteristics

(Non-warranted characteristics determined by design that are useful in applying the product)

Average resolution

Voltage	2.4 mV	5.9 mV	10.4 mV	18.0 mV	36.0 mV	60.0 mV
Current	4.6 mA	2.3 mA	1.4 mA	0.75 mA	0.39 mA	0.23 mA
Output voltage programming (OVP)	50 mV	120 mV	200 mV	375 mV	750 mV	1.25 mV
OVP accuracy	250 mV	500 mV	800 mV	1 V	1.5 V	2.5 V

Modular Power System 1200 W per mainframe GPIB (Continued)

66000 MPS mainframe. For applications with a broader range of power requirements, one 66000 mainframe can be connected with up to eight of the 6640, 6650, 6670, 6680, 6690 or 6030 series of system power supplies. This solution provides power ranges from 150 watts to 5000 watts at one primary GPIB address.

Output connections

System assembly is simplified thanks to a quick-disconnect connector assembly on each module. Once your wires are connected to the load, the connector design permits the modules to be removed from the front of the mainframe without disconnecting cabling or removing the mainframe from the rack. One connector assembly is shipped with each module.

Output sequencing

Increase test throughput by using the output sequencing feature of the 66000 MPS. This powerful feature allows you to download up to 20 voltage, current, and dwell-time parameter sets per output. This sequence can be paced by the programmed dwell times. As an alternative, triggers can be used to step through the output list. The output sequences can be executed without controller intervention, thereby increasing overall test system throughput. More detailed information on the triggering and output sequencing capabilities can be obtained by ordering the 66000 Modular Power System Product Note (p/n 5091-2497E).

Specifications

(at 0° to 55°C unless otherwise specified)

	66101A-J03 Special order option	66101A-J05 Special order option	66102A-J05 Special order option	66103A-J01 Special order option	66103A-J02 Special order option
Output ratings at 40°C					
Output voltage	5.7 V	12 V	15 V	37 V	40 V
Output current	20 A	12 A	10 A	4.5 A	3.6 A
Maximum power	114 W	144 W	150 W	167 W	144 W
Programming accuracy at 25°C ±5°C					
Voltage	0.03% +	2.5 mV	5 mV	8 mV	13 mV
Current	0.03% +	8 mA	6 mA	4 mA	2 mA
Readback accuracy (via GPIB keyboard display at 25°C ±5°C)					
Voltage	0.02% +	2 mV	3 mV	5 mV	8 mV
Current	0.02% +	8 mA	6 mA	4 mA	2 mA
Ripple and noise (20 Hz to 20 MHz)					
Constant voltage rms	2 mV	3 mV	3 mV	5.3 mV	6 mV
peak-peak	5 mV	7 mV	7 mV	10.6 mV	11.5 mV
Constant current rms	10 mA	8 mA	6 mA	2 mA	2 mA
Line regulation					
Voltage	0.5 mV	0.5 mV	0.5 mV	1 mV	1 mV
Current	0.5 mA	0.75 mA	0.5 mA	0.3 mA	0.3 mA
Load regulation					
Voltage	1 mV	1 mV	1 mV	1 mV	1 mV
Current	1 mA	0.5 mA	0.3 mA	0.2 mA	0.2 mA
Transient response time					
Less than 1 ms for the output voltage to recover within 100 mV of its previous level following any step change in load current up to 10 percent of rated current					
Supplemental Characteristics (Non-warranted characteristics determined by design that are useful in applying the product)					
Average resolution					
Voltage	2 mV	3.6 mV	4.5 mV	11 mV	12 mV
Current	6 mA	4.6 mA	3.1 mA	1.4 mA	1.2 mA
OVP	45 mV	75 mV	90 mV	200 mV	230 mV
OVP accuracy	250 mV	375 mV	375 mV	850 mV	920 mV

Application notes

66000 Modular Power System

Product Note
5988-2800EN

10 Practical Tips You Need to Know About Your Power Products
5965-8239E

10 Hints for Using Your Power Supply to Decrease Test Time
5968-6359E

Agilent DC Power Supplies for Base Station Testing
5988-2386EN

Modular Power System 1200 W per mainframe GPIB (Continued)

Supplemental characteristics for all model numbers

DC floating voltage: Output terminals can be floated up to ±240 VDC from chassis ground

Remote sensing: Up to half the rated output voltage can be dropped across each load lead. Add 2 mV to the voltage load regulation specification for each 1–V change in the negative output lead caused by a load current change.

Command processing time: The average time for the output voltage to change after getting an GPIB command is 20 ms.

Output programming response time (with full resistive load): The rise and fall time (10% to 90% and 90% to 10%) of the output voltage is less than 20 ms. The output voltage change settles within 0.1% of the final value in less than 120 ms.

Down programming: An active down-programmer sinks approximately 10% of the rated output current

Calibration interval: One year

AC input of system mainframe

Voltage 100 VAC 120 VAC 200 VAC 220 VAC 230 VAC 240 VAC

Max. current 29 A 25 A 16 A 16 A 15 A 15 A

Input power of system mainframe: 3200 VA (max.), 1800 W (max.), 1600 W (typ.)

GPIB capabilities: SH1, AH1, TE6, LE4, SR1, RL1, PP0, DC1, DT1, E1, and C0, and a command set compatible with IEEE-488.2 and SCPI

Software driver:
VXIPlug&Play

Regulatory compliance: Listed to UL 1244; certified to CSA 22.2 No. 231; conforms to IEC 61010-1.

Weight: Net, 66000A, 15 kg (33 lb); 66001A, 1.05 kg (2.3 lb); 66101-66106A, 2.8 kg (6 lb). Shipping, 66000A, 19 kg (42 lb); 66001A, 1.34 kg (2.95 lb); 66101–66106A, 4.1 kg (9 lb).

Size: 66000A: 425.7 mm W x 192 mm H x 677.93 mm D (16.76 in x 7.28 in x 26.69 in), including feet and rear connectors

Warranty: Three years

Specifications

(at 0° to 55°C unless otherwise specified)

66103A-J09

Special order option

66103A-J12

Special order option

66104A-J09

Special order option

66105A-J01

Special order option

Output ratings at 40°C

Output voltage	28.5 V	24 V	55 V	35 V
Output current	5.5 A	6 A	3 A	1.25 A
Maximum power	157 W	144 W	165 W	44 W

Programming accuracy at 25°C ±5°C

Voltage	0.03% +	13 mV	13 mV	25 mV	15 mV
Current	0.03% +	3 mA	3 mA	1.5 mA	0.6 mA

Readback accuracy (via GPIB or keyboard display at 25°C ±5°C)

Voltage	0.02% +	8 mV	8 mV	15 mV	9 mV
Current	0.02% +	3 mA	3 mA	1.2 mA	0.6 mA

Ripple and noise (20 Hz to 20 MHz)

Constant voltage rms	5 mV	5 mV	9 mV	6 mV
peak-peak	10 mV	10 mV	15 mV	11.5 mV
Constant current rms	4 mA	4 mA	1.2 mA	1 mA

Line regulation

Voltage	1 mV	1 mV	2 mV	1 mV
Current	0.3 mA	0.3 mA	0.1 mA	50 µA

Load regulation

Voltage	1 mV	1 mV	2 mV	1 mV
Current	0.2 mA	0.2 mA	0.1 mA	50 µA

Transient response time

Less than 1 ms for the output voltage to recover within 100 mV of its previous level following any step change in load current up to 10 percent of rated current

Supplemental Characteristics

(Non-warranted characteristics determined by design that are useful in applying the product)

Average resolution

Voltage	10.4 mV	8 mV	16.5 mV	2 mV
Current	2 mA	2 mA	0.9 mA	1.2 mA
OVP	200 mV	150 mV	350 mV	230 mV
OVP accuracy	800 mV	600 mV	950 mV	920 mV

Modular Power System 1200 W per mainframe GPIB (Continued)

Ordering information

66000A MPS mainframe

Opt 0L1 English printed programming and installation guide (full documentation on CD-ROM)

Opt 0B3 English printed service manual

A line cord option must be specified, see the AC line voltage and cord section.

66001A MPS keyboard includes 2 m (6 ft) cables

66002A Rack kit for 66001A keyboard

Module options

Opt 760 Open/close and polarity reversal relays

Opt J17 External Imon

Opt 0L1 English printed operating manual (full documentation on CD-ROM)

Opt 0B3 English printed service manual

Accessories

* **1CM023A** Rack mount flange and handle kit 132.6 mm H (3U) flange brackets

* **1CP013A** Rack mount flange and handle kit 177.0 mm H (4U) - two brackets and front handles

p/n 5060-3351 Field-installable relay kit

p/n 5060-3386 Standard connector assembly

p/n 5060-3387 Standard connector assembly with installed relays (Option 760)

p/n 1252-1488 4-Pin FLT/inhibit connector

E3663AC Support rails for Agilent rack cabinets

* Rack mounting requires cabinet rails (E3663AC) or a slide kit (p/n 1494-0059) to support the loaded mainframe's weight.

Agilent Models: 66000A

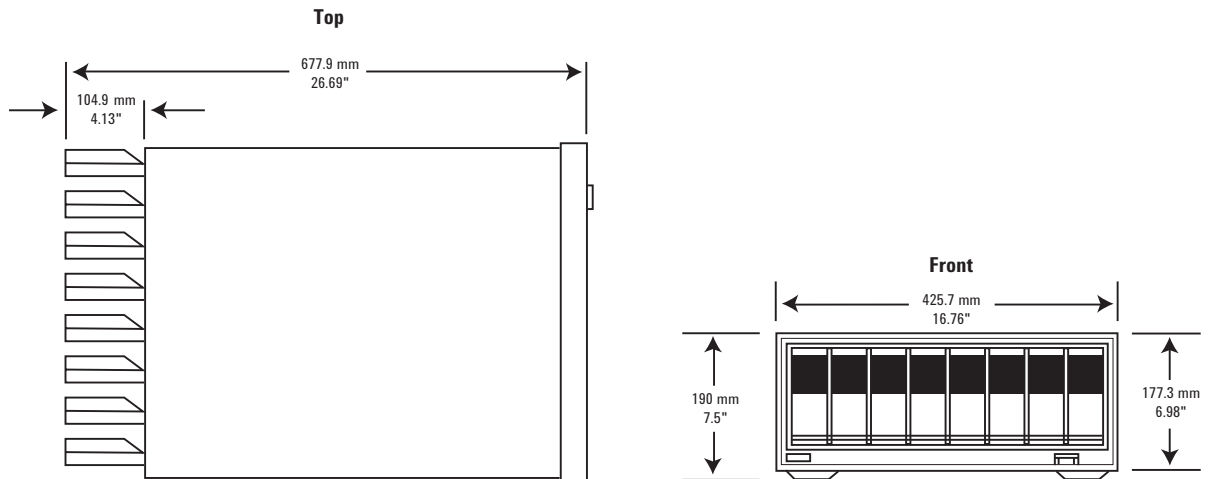

Modular DC Power Analyzer

600 W GPIB, LAN, USB, LXI Core

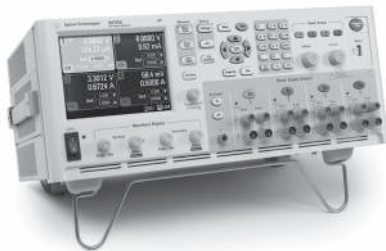

N6705B

Flexible configuration to meet your power sourcing and analysis requirements
 4-slot mainframe that accepts up to 4 DC power modules
 600 W total DC power module output power
 The modules are ordered separately

Specifications (at 0° to 55°C unless otherwise specified)	N6730B	N6740B	N6770A	N6751A N6752A	N6753A N6755A Note	N6754A N6756A
--	--------	--------	--------	------------------	--------------------------	------------------

New instrument category
 The Agilent N6705 DC Power Analyzer represents an entirely new instrument category for R&D engineers. It provides unrivaled productivity gains when sourcing and measuring DC voltage and current into a DUT. Using the Agilent N6705 DC Power Analyzer, R&D engineers can gain insights into the DUT’s power consumption in minutes without writing a single line of code. It provides an easy-to-use interface, with all sourcing and measuring functions available from the front panel. When automated bench setups are required, the N6705B is fully programmable over GPIB, USB, LAN and is LXI Core Compliant.

Modular System Based on DC Power Supply Outputs
 The Agilent N6705B DC power analyzer is a modular system that is tailorable to meet specific test needs. At the heart of the DC power analyzer is the DC power module. The Agilent N6705B DC power analyzer is a mainframe that has four slots to accept one to four DC power modules. Each DC power module takes one slot, except for the N6753A, N6754A 300 W and N6755A, N6756A 500 W high performance autoranging DC power

Output ratings*	N6730B	N6740B	N6770A	N6751A N6752A	N6753A N6755A Note	N6754A N6756A
Voltage	6 models 5 V to 100 V	6 models 5 V to 100 V	5 models 20 V to 150 V	50 V	20 V	60 V
Current	6 models 0.5 A to 10 A	6 models 1 A to 20 A	5 models 2 A to 15 A	5 A 10 A	50 A	20 A 17 A
Power	50 W	100 W	300 W	50 W 100 W	300 W 500 W	300 W 500 W
Autoranging	No	No	No	Yes	Yes	Yes
Measurement accuracy*						
Voltage	0.1% + 20 mV to 100 mV	0.1% + 20 mV to 100 mV	0.1% + 20 mV to 150 mV	0.05% + 20 mV	0.05% + 10 mV	0.06% + 25 mV
Current	0.15% + 2 mA to 20 mA	0.15% + 2 mA to 20 mA	0.15% + 6 mA to 15 mA	0.1% + 4 mA	0.1% + 30 mA	0.1% + 8 mA
Noise (20 Hz to 20 MHz)*	10 mVpp to 30 mVpp	11 mVpp to 30 mVpp	20 mVpp to 68 mVpp	0.35 mVrms 4.5 mVpp	1 mVrms 5 mVpp	1 mVrms 6 mVpp
Polarity reverse relays	Optional	Optional	Optional	Not available	Optional	Optional
Output relays	Optional	Optional	Optional	Optional	Optional	Optional

***Key Specifications** (Range of values for families of modules – see data sheet for specifics)
Scope: Up to 100 kHz digitizer for N673x, N674x, N675x, N676x, N677x, and N6783 modules;
 Up to 200 kHz for N678x SMUs
ARB: Approx max bandwidth = 5 kHz for N675x and N676x modules; 500 Hz for N673x, 4x, 7x, and 83 modules;
 100 kHz for N678x SMUs
Note: Requires special installation. Instructions ship with the module.

modules, and the N6763A, N6764A, 300 W and N6765A, N6766A 500 W precision autoranging DC power modules, which occupy two slots. The N6705B accepts the same modules as N6700 Low-Profile Modular Power System. Select from more than 30 different DC power modules ranging in capability from basic to high precision/source measure unit,

and in power from 20 W to 500 W. This modular design gives you the flexibility to mix and match over twenty different DC power modules to create a solution optimized to meet specific test requirements.

Modular DC Power Analyzer 600 W GPIB, LAN, USB, LXI Core (Continued)

Specifications (at 0° to 55°C unless otherwise specified)	N6761A N6762A	N6763A N6765A	N6764A N6766A	N6783A -BAT	N6781A N6782A	N6784A
		Note				

The Agilent N6705 DC power analyzer saves time

- Provides unrivaled productivity gains for sourcing and measuring DC voltage and current into your DUT by integrating up to four advanced power supplies with DMM, scope, arb, and data logger features.
- Eliminates the need to gather multiple pieces of equipment, create complex test setups including transducers (such as current probes and shunts) to measure current into your DUT.
- Eliminates the need to develop and debug programs to control a collection of instruments and take useful measurements because all the functions and measurements are available at the front panel.

Agilent N6705 DC power analyzer makes these tasks easy, right from the front panel

- Setup and view critical turn-on/turn-off sequences
- Measure and display voltage, current versus time to visualize power into the DUT
- Control DC bias supply ramp-up/down rates
- Generate DC bias supply transients and disturbances
- Log data for seconds, minutes, hours, or even days to see current consumption or capture anomalies
- Save data and screen shots to internal storage or external USB memory devices
- Save and name your setup and tests for easy re-use
- Share setups with colleagues

Output ratings						
Voltage	50 V	20 V	60 V	8 V	+20 V	±20 V
Current	1.5 A 3 A	50 A	20 A 17 A	+3 A -2 A	±3 A	±3 A
Power	50 W 100 W	300 W 500 W	300 W 500 W	24 W	20 W	20 W
Autoranging	Yes	Yes	Yes	No	No	No
Measurement accuracy						
Voltage	0.016% + 6 mV	0.03% + 10 mV	0.03% + 25 mV	0.05% + 5 mV	0.025% + 1.2 mV	0.025% + 1.2 mV
Current	0.04% + 160 µA**	0.1% + 10 mA	0.1% + 5 mA	0.1% + 600 µA	0.03% + 250 µA	0.03% + 250 µA
Noise (20 Hz to 20 MHz)	0.35 mVrms 4.5 mVpp	1 mVrms 5 mVpp	1 mVrms 6 mVpp	1.5 mVrms 8 mVpp	1.2 mVrms 12 mVpp	1.2 mVrms 12 mVpp
Polarity reverse relays	Not available	Not available	Not available	Not available	Not available	Not available
Output relays	Optional	Optional	Optional	Optional	Available	Available

**0.5% + 100 nA with Option 2UA

Scope: Up to 100 kHz digitizer for N673x, N674x, N675x, N676x, N677x, and N6783 modules; Up to 200 kHz for N678x SMUs

ARB: Approx max bandwidth = 5 kHz for N675x and N676x modules; 500 Hz for N673x, 4x, 7x, and 83 modules; 100 kHz for N678x SMUs

Note: Requires special installation. Instructions ship with the module.

New 14585A control and analysis software saves even more time

The new 14585A Control and Analysis Software is a companion PC application that gives you control of up to four N6705 main-frames from a single PC control screen. With this software, you get improved data visualization and data management.

Visit www.agilent.com/find/14585 for more information.

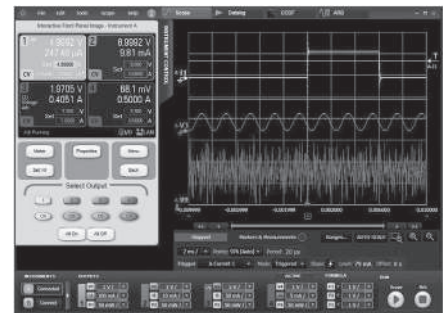

Modular DC Power Analyzer

600 W GPIB, LAN, USB, LXI Core (Continued)

Ordering information

Mainframe

N6705B DC power analyzer mainframe
Holds 1 to 4 modules. Total available output power = 600 W.

The N6705B mainframe and various modules can be ordered as separate products such that you can configure the system as needed.

N6715B build-to-order DC power analyzer system consists of 1 N6705B mainframe with total available power of 600 W.

The N6715B system is a build-to-order DC power analyzer system that is shipped as a fully assembled multiple-output power supply. Modules are ordered as options to the mainframe.

N6705U Upgrade Model

For more information, see www.agilent.com/find/N6705U

Options for N6705B/15B mainframes

Opt AKY Delete front/rear USB. This option removes all USB capability from the DC power analyzer. Both the front panel USB port and the rear panel USB port are removed.

Opt 055 Delete Data logger This option disables the data logger functionality in the DC power analyzer firmware. The DC power analyzer hardware is unchanged. To enable the data logger functionality at a later time, order the N6705U upgrade kit.

Opt 056 Add 14585A Software License

Opt 900 Power Cord, United Kingdom

Opt 901 Power Cord, Australia, New Zealand

Opt 902 Power Cord, Europe, Korea

Opt 903 Power Cord, USA, Canada, 120 V

Opt 904 Power Cord, USA, Canada, 240 V

Opt 906 Power Cord, Switzerland

Opt 912 Power Cord, Denmark

Opt 917 Power Cord, South Africa, India

Opt 918 Power Cord, Japan, 100 V

Opt 919 Power Cord, Israel

Opt 920 Power Cord, Argentina

Opt 921 Power Cord, Chile

Opt 922 Power Cord, China

Opt 927 Power Cord, Thailand, Brazil

Accessories

* **1CP005A** Rack mount flange and handle kit 177.0 mm H (4U) - two brackets and front handles

Agilent Models: N6705B, N6715B

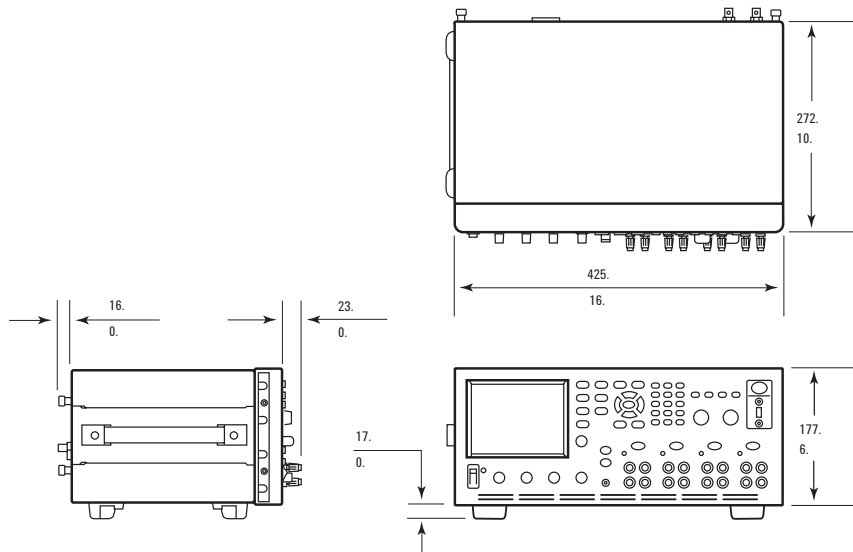

More detailed specifications at www.agilent.com/find/N6705B

Application Specific DC Power Supplies...

tailored solutions
for specific needs

Some applications require specialized DC power supplies. This section contains DC power supplies that provide the solutions needed to solve some very specific application problems.

Mobile Communication DC Sources

Battery life is a critical parameter for battery powered digital mobile communications devices such as cell phones, WLAN and Bluetooth™ enabled appliances. The pulsed characteristics of battery drain create unique powering and measuring requirements. With fast transient response, to react to pulsed current draw, and a flexible and fast measurement system, these DC sources are optimized for the needs of digital mobile communications devices.

Solar Array Simulators

Solar panels consisting of multiple solar arrays provide power to satellites. They have unique V-I characteristics. Since the output power of a solar array varies with environmental conditions (i.e. temperature, darkness, light intensity), a specialized power supply must be used for accurate simulation.

Source Measure Units

A Source/Measure Unit, or SMU, is a source and measurement instrument for test applications requiring high accuracy, high resolution and measurement flexibility. An SMU can precisely force voltage or current and simultaneously measure voltage and/or current. SMUs are sometimes also referred to as source monitor units.

Device Analyzer/Curve Tracers

Device analyzer/curve tracer series of products provide precision voltage and current plus make very low current and voltage measurements for semiconductor devices and new materials.

More detailed specifications at www.agilent.com/find/power

Application Specific Modules

N6783A-BAT, N6783A-MFG



N6783A-BAT, N6783A-MFG

Optimized for basic battery charge/discharge applications (N6783A-BAT)
 Optimized for mobile device manufacturing test (N6783A-MFG)
 Fast transient response ensures stable power supply output voltage
 Digitizing measurement system for flexible, accurate current measurements
 USB, LAN, and GPIB interfaces

Solution for battery-powered device designers

The Agilent N6783A-BAT Battery Charge/Discharge Module is a basic, 2-quadrant module designed to be used by battery-powered (mobile) device designers. During the research and development of a mobile device it is necessary to properly validate the battery that will be used in the final design, especially if the design calls for the battery to be permanently installed. Battery validation requires charging and discharging the battery while making measurements of voltage and current to ensure it meets its specifications and will operate in the device as expected.

The N6783A-BAT's 2-quadrant operation allows it to act as a power supply to charge the battery or as an electronic load to discharge the battery. Its built-in, digitizing measurement system allows accurate measurements over the short and

Mainframe Characteristics

	N6700B	N6701B	N6702B	N6705B
Power (sum of module output)	400 W	600 W	1200 W	600 W
Configuration	Flexible / reconfigurable			
Available slots	4 - mainframe accepts up to 4 DC power modules			
Instrument control	GPIB, USB, LAN (LXI Core Compliant)			

Module Specifications

	N6783A-BAT	N6783A-MFG
DC output ratings		
Voltage	8 V	6 V
Current (derated 1% per °C above 40°C)	+3 A/-2 ¹	+3 A/-2 ¹
Power	24 W	18 W
Output voltage ripple & noise (PARD) (from 20 Hz - 20 MHz)		
CV peak-to-peak	8 mV	8 mV
CV rms	1.5 mV	1.5 mV
Load effect (Regulation) (for any output load change, with a maximum load-lead drop of 0.5 V/lead)		
Voltage	6 mV	6 mV
Current	2 mA	2 mA
Source effect (Regulation)		
Voltage	2 mV	2 mV
Current	1 mA	1 mA
Programming accuracy (At 23 °C ±5 °C after 30 min. warm-up)		
Voltage	0.1% + 10 mV	10 mV
Positive Current	0.1% + 1.8 mA	1.8 mA
Negative Current @ -2 A	0.2% + 1.8 mA	N/A

Notes:

¹ Output may provide peak currents up to 5 A for a maximum of 0.5 second

More detailed specifications at www.agilent.com/find/N6783A-BAT
www.agilent.com/find/N6783A-MFG

Application Specific Modules N6783A-BAT, N6783A-MFG (Continued)

long-term. When used in the N6705B DC Power Analyzer mainframe short and long-term measurements for battery validation are made easy.

The N6783A-BAT can also be used to condition batteries for test in mobile devices by charging or discharging the battery to a specific level in order to see how the device performs under specific conditions. This allows R&D engineers to understand real-world operation of their designs during different levels of charge.

The N6783A-BAT can be used for battery charge/discharge only. For advanced battery test, battery drain analysis and battery emulation use the N6781A 2-Quadrant SMU for Battery Drain Analysis.

Solution for battery powered device manufacturers

The N6783A-MFG Mobile Communications DC Power Module offers advanced features specifically for testing battery-powered (mobile) devices in manufacturing. The N6783A-MFG's excellent voltage transient response ensures a stable output voltage is maintained at the device under test (DUT) during load transients. This maximizes system throughput by eliminating inadvertent device shutdowns that occur if the voltage is allowed to droop too low, such as when a non-specialized power supply is used. The built-in digitizer also allows for maximum throughput by providing fast, accurate, flexible measurements that are customizable to the level of speed and accuracy desired.

Module Specifications	N6783A-BAT	N6783A-MFG
Measurement Accuracy (At 23 °C ±5 °C)		
Voltage	0.05% + 5 mV ²	5 mV ²
Current high range	0.1% + 600 μA ²	600 μA ²
Current low range (≤ 150 mA)	75 μA ²	75 μA ²
Programming Resolution		
Voltage	2.5 mV	2.5 mV
Positive Current	1 mA	1 mA
Negative Current	10 mA	N/A
Maximum Up-Programming and Down-Programming Time with Full Resistive Load (time from 10% to 90% of total voltage excursion)		
Voltage Settling from 0 V to Full Scale	4.0 ms	4.0 ms
Voltage Settling from Full Scale to 0 V	4.0 ms	4.0 ms
Maximum Up-Programming and Down-Programming Settling Time with Full Resistive Load (time from start of voltage change until voltage settles within 0.1% of the full-scale voltage of its final value)		
Voltage Settling from 0 V to Full Scale	20 ms	20 ms
Voltage Settling from Full Scale to 0 V	20 ms	20 ms
Over-voltage Protection		
Accuracy without disconnect relays	0.25% + 75 mV	75 mV
Accuracy with disconnect relays	0.25% + 275 mV	275 mV
Nominal range	0 – 10 V	0 – 10 V
Programmable delay time (from occurrence of over-voltage condition to start of output shutdown)	60 μs – 5 ms	60 μs – 5 ms
Over-Current Protection		
Programmable delay time	0 – 255 ms	0 – 255 ms
Nominal Range	5 mA – 3.06 A	5 mA – 3.06 A
Output Ripple and Noise: (PARD)		
CC rms	4 mA	4 mA
Common Mode Noise (from 20 Hz – 20 MHz; from either output to chassis)		
Rms	1 mA	1 mA
Peak-to-peak	6 mA	6 mA

Notes:

² Applies when measuring the default value of 1024 data points

More detailed specifications at www.agilent.com/find/N6783A-BAT
www.agilent.com/find/N6783A-MFG

Application Specific Modules N6783A-BAT, N6783A-MFG (Continued)

Supplemental Characteristics	N6783A-BAT	N6783A-MFG
Load Transient Recovery (assumes standard GSM pulse test as defined in the figure below)		
Transient Voltage Dip ³	75 mV	75 mV
Time ⁴	< 45 μ s	< 45 μ s
Transient Voltage Dip with Disconnect Relay installed	90 mV	90 mV
Time with Disconnect Relay Installed ⁴	< 75 μ s	< 75 μ s
Remote Sense Capability Outputs can maintain DC specifications with up to a 0.5-volt drop per load lead. Maximum sense lead resistance is limited to 300 m Ω /lead.		
Down-programming Capability		
Continuous power	12 W	12 W
Continuous current ⁵	2 A	2 A

The N6783A-MFG, when used in the N6700B Low-Profile mainframe, offers industry-leading output density with up to 4 outputs in 1U of rack space. GPIB, LAN, USB, and LXI Core compliance are standard.

Part of a Modular Power System

The N6783A-BAT and N6783A-MFG modules can be used with the N6700 low-profile mainframes for automated test and with the N6705 DC power analyzer mainframe for R&D. Select from more than 30 different DC power modules ranging in capability from basic to high precision, and in power from 20-500 W; see N6700 Low Profile Modular Power System section for details.

Ordering Information

N6783A-BAT Battery Charge/Discharge Module

N6782A-MFG Mobile Communications DC Power Module

N6705B-056 Software License to Control N6705A/B with 14585A Control and Analysis Software (Option to the N6705B when ordered new)

N6705U-056 Upgrade an N6705A/B DC Power Analyzer with 14585A Software License

Notes:

³ Voltage measured at the sense point

⁴ Time for the output to recover to 20 mV below its final setting

⁵ Applies above 0.50 V out

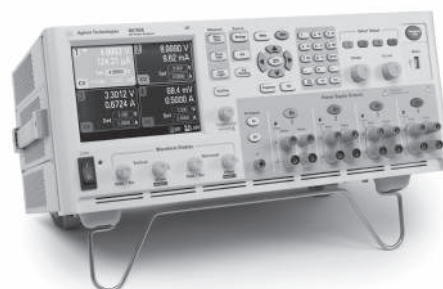

N6705B



N6700B - N6702B

More detailed specifications at www.agilent.com/find/N6783A-BAT
www.agilent.com/find/N6783A-MFG

Mobile Communications DC Sources 40-100 W



66319B/D, 66321B/D

Ideal for testing wireless and battery powered devices

Several times improvement in measurement throughput over general purpose DC sources

Superior output transient performance with short or long load leads (up to 6 meters)

Dynamic measurement system for accurate battery current drain measurement

New easy-to-use Graphical User Interface and analysis tools for bench top use

Overcome battery powered device testing challenges

Digital communications devices and digital battery powered devices present a unique testing challenge: they draw rapid pulses of current. By offering superior transient performance, unmatched in the marketplace, the Agilent mobile communications DC sources dramatically reduce the transient voltage drop due to pulse loading characteristics of digital communications devices. The Agilent mobile communications DC sources enable you to maximize test throughput by minimizing test interruption due to false trigger of device low voltage shutdown.

Dynamic measurement capabilities

The Agilent mobile communications DC sources offer a built-in advanced measurement system to accurately measure battery current drains when the device operates in different modes (such as talk mode, active mode, standby mode, and off/sleep mode). Measurements made during these modes are critical for ensuring that your devices are operating properly and that you are getting the most out of the battery.

Simulate both main battery and charger

Single output models are recommended when you need to provide power as a replacement to your

Specifications

(at 0° to 55°C unless otherwise specified)

	66309B/D	66311B	66319B/D	66321B/D	66332A ¹	66332A-J01 Special order option	
Number of outputs	2	1	2	1	1	1	
 GPIB 	Yes	Yes	Yes	Yes	Yes	Yes	
Output ratings							
Voltage	0 to 15 V	0 to 15 V	0 to 15 V	0 to 15 V	0 to 20 V	0 to 30 V	
Current	0 to 3 A	0 to 3 A	0 to 3 A	0 to 3 A	0 to 5 A	0 to 3.3 A	
Peak current for up to 7 ms	5 A	5 A	5 A	5 A	5 A	3.3 A	
Programming accuracy at 25°C ±5°C (% of setting plus fixed)							
Voltage	0.05%+	10 mV	10 mV	10 mV	10 mV	15 mV	
+Current	0.05%+	1.33 mA	1.33 mA	1.33 mA	2 mA	2 mA	
Ripple and noise (20 Hz to 20 MHz)							
Voltage	rms	1 mV	1 mV	1 mV	1 mV	0.3 mV	0.5 mV
	peak-to-peak	6 mV	6 mV	6 mV	6 mV	3 mV	5 mV
Current	rms	2 mA	2 mA	2 mA	2 mA	2 mA	2 mA
DC measurement accuracy							
Voltage	0.03%+	5 mV	5 mV	5 mV	5 mV	3 mV	5 mV
+20 mA to + rated current	0.2%+	0.5 mA ²	0.5 mA ²	—	—	0.5 mA	0.5 mA
-20 mA to - rated current	0.2%+	1.1 mA	1.1 mA	—	—	1.1 mA	1.1 mA
-3 A to + 5 A	0.2%	—	—	0.5 mA ²	0.5 mA ²	—	—
-1 A to + 1 A	0.1%	—	—	0.2 mA	0.2 mA	—	—
-20 mA to + 20 mA range	0.1%+	2.5 μA	2.5 μA	2.5 μA	2.5 μA	2.5 μA	2.5 μA
Dynamic measurement system							
Buffer size	4096 points	4096 points	4096 points	4096 points	4096 points	4096 points	
Sampling interval	15 μs - 31,200 s	15 μs - 31,200 s	15 μs - 31,200 s	15 μs - 31,200 s	15 μs - 31,200 s	15 μs - 31,200 s	
Transient response time	<35 μs ³	<35 μs ³	<20 μs ³	<20 μs	<100 μs ⁴	<100 μs ⁴	
Transient voltage dip (typical with up to 15 feet 22 AWG wiring)	70 mV	70 mV	40 mV	40 mV	500 mV	650 mV	

Notes:

- ¹ 66332A also has RS-232 interface.
- ² Applies with current detector set to DC.
- ³ Time for the output voltage to recover to within 20 mV of final value after 0.1 to 1.5 A load change in high capacitance compensation range.
- ⁴ Time for the output voltage to recover to within 20 mV or 0.1% of the voltage rating of the unit following a change in load current of up to 50% of the output current rating.

Mobile Communications DC Sources 40-100 W (Continued)

device's main battery during testing. Dual output models are recommended when you need to provide power as a replacement to your device's main battery and when you need to simulate the battery charger power; Use one output to supply current to the battery charger input port and the second output to connect in place of the main battery (which sinks current to simulate the main battery being charged).

Performs like a battery

With their battery emulation features, the Agilent 66319B/D and 66321B/D allow you to test your devices under the same power conditions that exist in actual use. Emulating the battery is key when characterizing battery operating life and detecting early product failures. These DC sources simulate the effects of internal resistance of the battery, enabling them to emulate the operation of various battery types or batteries in different charge states. Plus, these DC sources can simulate negative resistance so that you can compensate for voltage drop due to wiring in a fixture.

Feature summary

Agilent has designed in the capability and flexibility that is required for accurately testing today's communications devices as well as your next generation designs for cell phones (formats include: 3G, cdma2000, WCDMA, CDMA, TDMA, GSM, PCS, DECT, TETRA, PHS, NADC), PDAs, Bluetooth™ enabled devices, and Wireless LAN access devices.

Specifications (at 0° to 55°C unless otherwise specified)	66309B/D	66311B	66319B/D	66321B/D	66332A	66332A-J01 Special order option
Programmable output resistance						
Range	—	—	-40 mΩ to +1 Ω	-40 mΩ to +1 Ω	—	—
Programming accuracy	—	—	0.5% + 2 mΩ	0.5% + 2 mΩ	—	—
Resolution	—	—	1 mΩ	1 mΩ	—	—
Voltmeter input (66309D, 66319D, and 66321D only)						
Input range	-25 to +25 VDC	—	-25 to +25 VDC	-25 to +25 VDC	—	—
DC readback accuracy (at 25°C ±5°C)	0.04% + 5 mV	—	0.04% + 5 mV	0.04% + 5 mV	—	—
AC + DC readback accuracy (at 25°C ±5°C) with DC plus a sinewave input > 25 mVrms	1% + 5 mV (60 Hz to 10 kHz)	—	1% + 5 mV (60 Hz to 10 kHz)	1% + 5 mV (60 Hz to 10 kHz)	—	—
Auxiliary output (66309B/D and 66319B/D)						
Output ratings	Voltage 0 to 12 V		0 to 12 V		—	—
	Current 0 to 1.5 A		0 to 1.5 A		—	—
Programming accuracy	Voltage 0.2% + 40 mV		0.2% + 40 mV		—	—
	+Current 0.2% + 4.5 mA		0.2% + 4.5 mA		—	—
DC measurement accuracy	Voltage 0.2% + 15 mV		0.2% + 15 mV		—	—
	+Current 0.2% + 3 mA		0.2% + 3 mA		—	—
Ripple and noise (20 Hz to 20 MHz)						
Voltage	rms	1 mV	—	1 mV	—	—
	peak-to-peak	6 mV	—	6 mV	—	—
Current	rms	2 mA	—	2 mA	—	—

Supplemental Characteristics

(Non-warranted characteristics determined by design and useful in applying the product)

DC floating voltage

Output terminals can be floated up to ±50 VDC maximum from chassis ground (±240 VDC for 66332A)

Remote sensing voltage drop

For 66332A: Up to 2 V can be dropped in each load lead. Add 2 mV to the load regulation specification for each 1 V drop in the positive output lead. For 66309B/D, 66311B: Up to 4 V can be dropped in each load lead. Add 2 mV to the load regulation specification for each 1 V drop in the positive output lead. For 66319B/D main output, 66321B/D main output: Up to 3 V total can be dropped in

both load leads. For 66319B/D auxiliary output, 66321B/D auxiliary output: Up to 4 V total can be dropped in both load leads.

Command processing time

Average time required for the output voltage to begin to change following receipt of GPIB data is 4 ms (with display disabled).

Mobile Communications DC Sources 40-100 W (Continued)

All models offer:

- Fast output response technology
- Programmable output response compensation
- Advanced DSP-based dynamic measurements
- Current sinking for testing and calibrating charger circuitry
- Extensive protection features (including broken sense lead detection)
- GPIB Interface, SCPI (Standard Commands for Programmable Instruments), *VXIplug&play* drivers

In addition, the 66319B/D and 66321B/D high performance models offer:

- Output resistance programming (positive and negative)
- Superior output stability with up to 6 meters of load leads
- Excellent transient voltage drop (typically < 30 mV)
- Three current measurement ranges
- NEW! Additional advanced battery drain measurements (CCDF, long term battery drain)

The new and improved 66319B/D and 66321B/D high performance models are recommended for new automated test system platforms and for R&D applications. The 66309B/D and the 66311B are available for those customers who need to replicate existing test platforms and who do not want to re-engineer existing automated test system designs.

Supplemental Characteristics

(Non-warranted characteristics determined by design and useful in applying the product)

(Continued)

Output programming response time

For 66332A: The rise and fall time (10/90% and 90/10%) of the output voltage is < 2 ms (400 μ s in fast mode). The output voltage change settles within 1 LSB (0.025% x full scale voltage) of final value in < 6 ms (2 ms in fast mode).
For 66311B, 66321B/D, 66309B/D output 1, 66319B/D output 1: The rise and fall time (10/90% and 90/10%) of the output voltage is < 200 μ s.

Measurement time

Average time to process query, calculate measurement parameter and return data is 50 ms (includes the default time of 30 ms for acquiring data and 20 ms data processing overhead).

GPIB interface capabilities

IEEE-488.2, SCPI command set, 6630A series programming capability (not supported in 66309B/D, 66319B/D, 66321B/D)

Software driver

- *VXIPlug&Play*
- IntuiLink Connectivity Software

Input power

(at worst case conditions: full load, 100 VAC mains)
For 66311B, 66321B/D: 1.7 A, 125 W.
For 66309B/D, 66319B/D: 2 A, 170 W.
For 66332A: 3.5 A, 250 W.

Regulatory compliance

Complies with EMC directive 89/336/EEC (ISM 1B).

Warranty: Three years

Size

For 66309B/D, 66311B, 66319B/D, 66321B/D: 212.8 mm W x 88.1 mm H x 435 mm D (8.4 in x 3.5 in x 17.13 in).
For 66332A: 425.5 mm W x 88.1 mm H x 364.4 mm D (16.8 in x 3.5 in x 14.3 in).

Weight

For 66309B/D, 66311B, 66319B/D, 66321B/D: 9.07 kg (20 lb) net, 11.1 kg (24.5 lb) shipping. For 66332A: 12.7 kg (28 lb) net, 15.0 kg (33 lb) shipping.

Application notes

Mobile Communications Device Testing

(AN 1310)
5968-2424EN

Evaluating Battery Run-down Performance Using the Agilent 66319D or 66321D with Option #053 14565A

Device Characterization Software
(AN 1427)
5988-8157EN

Using Battery Drain Analysis to Improve Mobile-Device Operating Time

5988-7772EN

Current Drain Analysis Enhances WLAN Network Card Design and Test

(AN 1468)
5989-0565EN

Mobile Communications DC Sources 40-100 W (Continued)

Ordering information

- Opt 100** 87 to 106 Vac, 47 to 63 Hz
- Opt 120** 104 to 127 Vac, 47 to 63 Hz
- Opt 220** 191 to 233 Vac, 47 to 63 Hz
- Opt 230** 207 to 253 Vac, 47 to 63 Hz
- Opt 004** Make "Hi Compensation Mode" as default setting
- Opt 007** Extra 5-pin output connectors (2 x p/n 0360-2604)
- Opt 020** Front-panel binding posts (66332A only)
- Opt UJ0** No front panel binding posts (66332A only)
- Opt 521** Solid state relays (66309B/D, 66319B/D)
- Opt AYK** No solid state relays (66309B/D, 66319B/D)
- Opt 760** Isolation and reversal relays (66332A only)
- Opt 8ZJ** Delete feet
- Opt 8ZL** Include feet
- Opt 0L1** English printed users guide (full documentation on CD-ROM)
- Opt 0B3** English printed service manual

Accessories

- * **1CM024A** Rack mount flange kit including filler panel 88.1 mm H (2U) - one bracket, one half-module bracket (66309B/D, 66311B, 66319B/D, 66321B/D)
- * **1CM002A** Rack mount flange kit 88.1 mm H (2U) - two flange brackets; 1.75 in hole spacing (66332A)
- * **1CP001A** Rack mount flange and handle kit 88.1 mm H (2U) - two brackets and front handles (66332A)
- * **1CM021A** Rack mount flange kit 88.1 mm H (2U) - 1.75 in hole space, side-by-side mounting (N/A for 66332A)
- p/n 1494-0060** Rack slide kit (66332A only)

E3663AC Support rails for Agilent rack cabinets

14565B Device Characterization with Battery Drain Analysis & Test Automation

14565U Device Characterization Software Upgrade (provides upgrade from 14565A to 14565B Software)

Note: Battery Drain Analysis means Data Logging and CCDF measurements. These capabilities require models 66319B, 66319D, 66321B or 66321D with version A.03.00 firmware or higher and 14565B or 14565A software version 3.01 or higher.

* Support rails required

Agilent Models: 66309B/D, 66311B, 66319B/D, 66321B/D

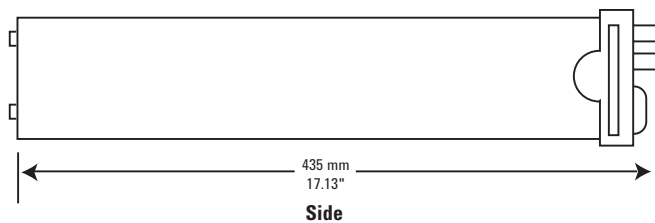
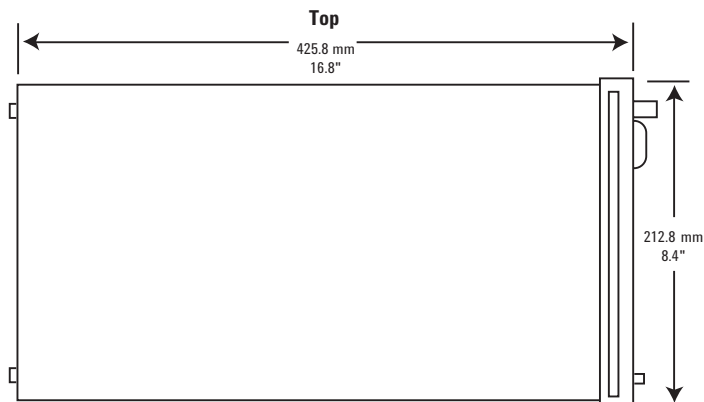
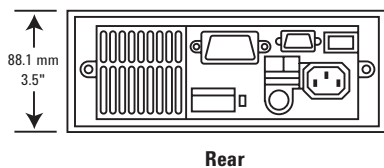

More detailed specifications at www.agilent.com/find/66300

Mobile Communications DC Sources

40-100 W (Continued)

Agilent Models: 66332A

Terminal Strip Detail

Output 2 & 3

+S + - S ⊥



Screw Size:
M35 x 0.6

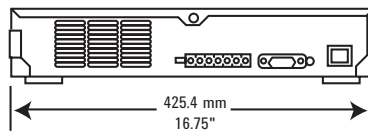

Rear

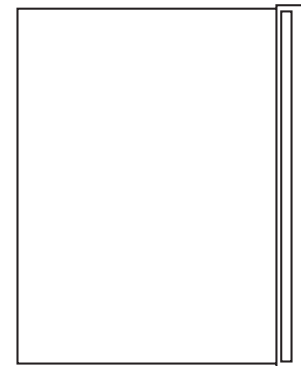
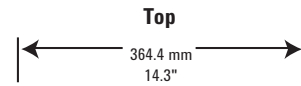

Side

Mobile Communications DC Sources 14565B Device Characterization Software



Ideal for testing wireless and battery powered devices
 Converts mobile communications DC source into a powerful bench-top tool for R&D and Repair
 Easy-to-use Graphical User Interface and analysis tools
 No programming required

Simplify test and analysis in R&D or on the repair bench

With the Agilent 14565B Device Characterization Software, testing, analyzing, and troubleshooting wireless and battery powered devices is made simple. The 14565B provides a graphical user interface that lets you easily control the mobile communications DC sources. It gives you access to the mobile communications DC source's high-powered measurement system and provides an oscilloscope-like view of the voltage or current waveforms of the device under test. The 14565B provides reference waveform save/recall, and provides oscilloscope-like measurement and analysis including voltage and current waveform parameter measurements, triggering, markers, zoom control, and more. By using the advanced capabilities built into the power supply, you can spend more time testing and analyzing instead of configuring and reconfiguring multiple pieces of test equipment, such as a current shunt, oscilloscope, current probe, DMM, and datalogger.

Waveform capture mode

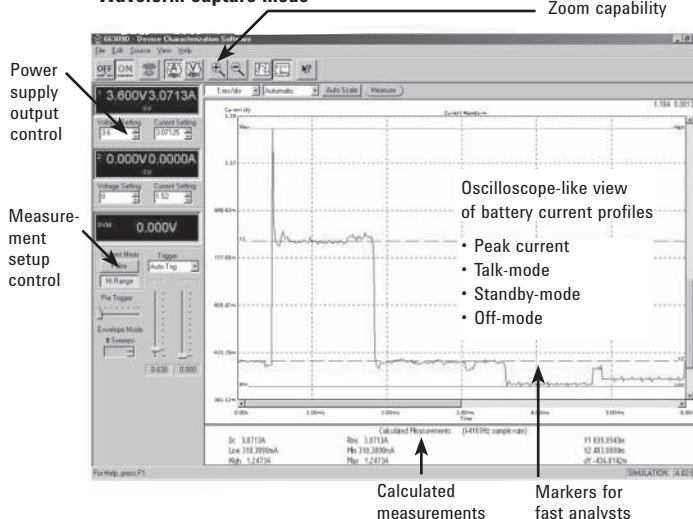

Data logging mode

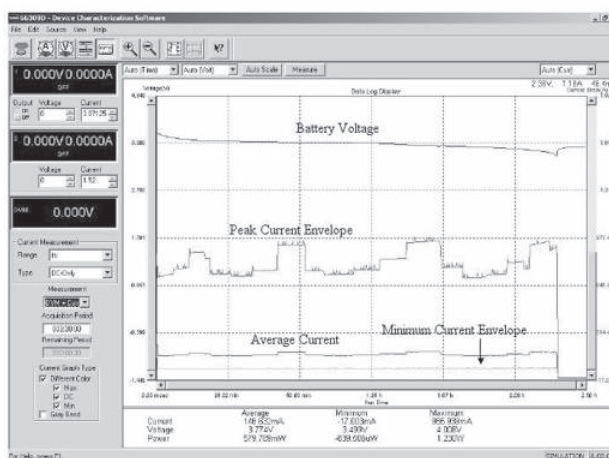

More detailed specifications at www.agilent.com/find/14565B

Mobile Communications DC Sources Device Characterization Software (Continued)

When coupled with the 66319B/D or the 66321B/D, the 14565B also provides Battery Drain Analysis capabilities. More than just measuring battery run time, Battery Drain Analysis allows you to characterize current out of the battery and make tradeoffs in design that impact the current drain and battery life. By providing CCDF measurements and long-term battery drain data logging, the 14565B and 66319/21 provide a complete solution for analyzing current drain so that you can optimize your device designs to achieve maximum battery run time.

Save time with test automation

New capability makes it easy to automate battery current drain analysis. The 14565B can be controlled from various programs and programming languages such as the Agilent Wireless Test Manager, NI LabView™, Agilent VEE, Microsoft Visual Basic, Microsoft Excel and others. Save valuable resource and time by automating time consuming, repetitive tasks associated with characterizing battery current drains during real world operation (like video streaming, music downloads, text messaging). The 14565B Device Characterization Software with test automation reduces setup and test time, reduces manual intervention, and provides battery drain measurement and analysis.

Key features

For R&D

- Fast and easy test setup
- Digitize current waveforms
- Accurately log battery current drain measurements from 10 seconds to 1000 hours at 64,000 measurements per second
- New automation capability provides operational control from many test applications
- Test designs simulating different battery conditions with programmable output resistance
- Zoom capability for analyzing waveform anomalies
- Adjust markers for fast measurements on digitized waveforms
- Easily document your test results
- Record test data to files for archive or analysis by other software packages

For repair

- Compact design with multiple instrument functionality
- Fast and easy test setup
- Graphical user software, no programming required
- Dual DC outputs for replacing the main battery and the power adapter/charger power source
- Electronic load for testing the battery charger circuitry
- Programmable soft limits to protect against incorrect voltage settings

Ordering information

14565B Device Characterization with Battery Drain Analysis & Test Automation

14565U Device Characterization Software Upgrade (provides upgrade from 14565A to 14565B Software)

Note: Battery Drain Analysis means Data Logging and CCDF measurements. These capabilities require models 6319B, 66319D, 66321B or 66321D with version A.03.00 firmware or higher and 14565B or 14565A software version 3.01 or higher.

Modular Solar Array Simulators 1200 W

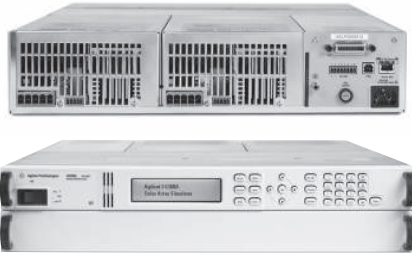

E4360A, E4361A, E4362A,
E4361A-J01, E4362A-J01, E4362A-J02

- Accurate simulation of any type of solar array
- Small size: up to 2 outputs in 2U of rack space
- High output power – up to 600 W per output
- Fast I-V curve change and fast recovery switching time
- Easy to simulate environmental conditions
- LAN, USB, and GPIB interfaces standard
- Custom turn-key system or individual instruments available

Specifications

(at 0° to 40°C unless otherwise specified)

	E4361A	E4362A	E4361A-J01	E4362A-J01	E4362A-J02
Output ratings					
Simulator and table mode					
Max. Power	510 W	600 W	497.6 W	594 W	594 W
Max. Open Circuit Voltage (V _{oc})	65 V	130 V	58 V	117 V	120 V
Max. Voltage Point (V _{mp})	60 V	120 V	53.5 V	108 V	110 V
Line Voltage: 200 V/230 V/240 V					
Max. Short Circuit Current (I _{sc})	8.5 A	5.0 A	9.3 A	5.5 A	5.4 A
Max. Circuit Point (I _{mp}) ¹	8.5 A	5.0 A	9.3 A	5.5 A	5.4 A
Line Voltage: 100 V/120 V ¹					
Max. Short Circuit Current (I _{sc})	4.25 A	2.5 A	4.65 A	2.75 A	2.7 A
Max. Circuit Point (I _{mp})	4.25 A	2.5 A	4.65 A	2.75 A	2.7 A
Output Ratings (Fixed Mode)					
Voltage	0 - 60 V	0 - 120 V	0 - 53.5 V	0 - 108 V	0 - 110 V
Line Voltage: 200 V/230 V/240 V					
Current	0 - 8.5 A	0 - 5.0 A	0 - 9.3 A	0 - 5.5 A	0 - 5.4 A
Line Voltage: 100 V/120 V ¹					
Current	0 - 4.25 A	0 - 2.5 A	0 - 4.65 A	0 - 2.75 A	0 - 2.7 A
Output Voltage Ripple & Noise (from 20 Hz to 20 MHz with a resistive load, outputs ungrounded, or either output grounded)					
Simulator/Table mode	20 mV _{rms}	24 mV _{rms}	20 mV _{rms}	24 mV _{rms}	24 mV _{rms}
	125 mV _{p-p}	195 mV _{p-p}	125 mV _{p-p}	195 mV _{p-p}	195 mV _{p-p}
Fixed mode (constant voltage)	24 mV _{rms}	30 mV _{rms}	24 mV _{rms}	30 mV _{rms}	30 mV _{rms}
	150 mV _{p-p}	150 mV _{p-p}	150 mV _{p-p}	150 mV _{p-p}	150 mV _{p-p}
Programming Accuracy^{1,2} (@ 23°C ±5°C)					
Fixed Mode Voltage	0.075% + 25 mV	0.075% + 50 mV	0.075% + 22 mV	0.075% + 50 mV	0.075% + 50 mV
Fixed Mode Current	0.2% + 20 mA	0.2% + 10 mA	0.2% + 22 mA	0.2% + 11 mA	0.2% + 11 mA

¹ There is no current derating when only one output module is installed in the mainframe.

² In Simulator mode, the output current is related to the readback output voltage by an internal algorithm. In Table mode, the output current is related to the readback output voltage by interpolation between points that are entered by the user.

³ The unit may go out of specification when subjected to RF fields of 3 volts/meter in the frequency range of 26 MHz to 1 GHz.

Solar Array Simulation

Solar panels consisting of multiple solar arrays provide power to satellites. They have unique I-V characteristics. Since the output power of a solar array varies with environmental conditions (i.e. temperature, darkness, light intensity), a specialized power supply like a solar array simulator must be used for accurate simulation.

Next Generation Solar Array Simulator

The Agilent E4360 modular solar array simulator (SAS) is a dual output programmable DC power source that simulates the output characteristics of a solar array. The E4360 SAS is primarily a current source with very low output capacitance and is capable of quickly simulating the I-V curve of different arrays under different conditions (ex. temperature, age etc.). It provides up to 2 outputs and up to 1200 W in a small 2U-high mainframe.

Whether you build your own test system requiring instrument only or if you want a full turn-key system with all the instruments and software integrated and installed, Agilent gives you the flexibility you need. The E4360 SAS is readily available as an off-the-shelf instrument and also is available from Agilent integrated into a full turn-key solar array simulator system configured to your exact specification.

More detailed specifications at www.agilent.com/find/E4360

Modular Solar Array Simulators: 1200 W (Continued)

Multiple Simulation Modes

The E4360 SAS provides three operating modes, Simulator, Table and Fixed modes. To accurately simulate the I-V curve of a solar array, use simulation or table modes. When a standard power supply is needed, use fixed mode.

1. Simulator Mode:

The E4360 SAS internally generates a 4,096 I-V point table. An internal algorithm is used to approximate an I-V curve. This can be done via the I/O interfaces or from the front panel where a PC is not needed. These four input parameters are needed to establish a curve in this mode:

- V_{oc} - open circuit voltage
- I_{sc} - short circuit current
- I_{mp} - current at the peak power point on the curve
- V_{mp} - voltage at the peak power point on the curve

2. Table Mode:

The I-V curve is determined by a user-defined table of points. A table can have a minimum of 3 points, up to a maximum of 4000 points. A point corresponds to a specific value of I and V. As many as 30 tables may be stored in each of the E4360 SAS built-in volatile and non-volatile memory. The tables (I-V curve) stored in this non-volatile memory

E4360A Modular Solar Array Simulator mainframe

Maximum Total Output Power (= sum of total module output power)	1200 W
AC Line Voltage Ratings	
Nominal Input Range	100 VAC - 240 VAC; 50/60 Hz/400 Hz
Input Range	86 VAC - 264 VAC
Maximum Input Power with two modules installed	2000 VA; 2000 W
Maximum AC Line Current Ratings	
with two modules installed	Reduced output power 100 VAC range, 12 Arms (300 W per module) 120 VAC range, 10 Arms
Full output power	
	220 VAC range, 9.7 Arms 230 VAC range, 8.4 Arms 240 VAC range, 8.4 Arms
Command Processing Time	≤1 ms from receipt of command to start of output change
Protection Response	INH input, 5 μs from receipt of inhibit to start of shutdown
Characteristics	Fault on coupled outputs, <10 μs from receipt of fault to start of shutdown

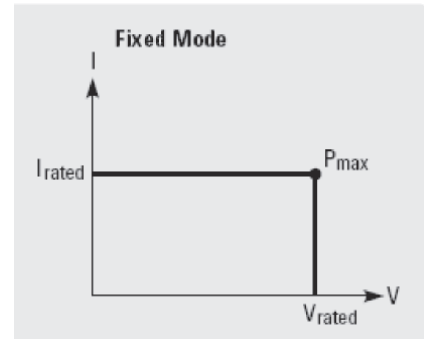
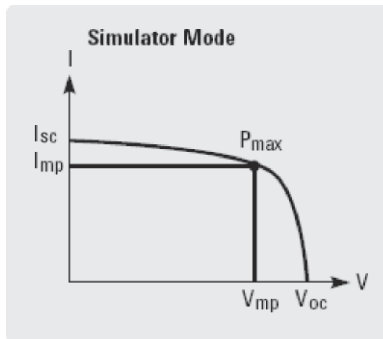

will be retained when the power is turned off, while those stored in volatile memory will be erased after power is removed.

Additionally, current and voltage offsets can be applied to the selected table to simulate a change in the operating conditions of the solar array.

3. Fixed Mode:

This is the default mode when the unit is powered on. The unit has the rectangular I-V characteristics of a standard power supply.

Modular Solar Array Simulators: 1200 W (Continued)

Fast I-V Curve Changes

The E4360 offers fast curve changes to enable better simulation of solar arrays under various environmental conditions, like eclipse and spin. The resolution of the I-V curve can be set to optimize the I-V curve for resolution or fast curve change. In simulation mode and table mode, you can select high resolution which uses a 4,096 point table to generate a smoother I-V curve within 250 msec. For fast I-V curve generation, you can select the 256 point table that quickly generates an I-V curve within 30 msec. All the E4360 SAS in the system can be synchronized to change their I-V curves at the same time using the hardware trigger, such that I-V curves can be changed on up to 100 outputs within 30 msec or 250 msec based on resolution setting.

I-V Curve List

The E4360 offers a LIST mode that lets you pre-program a LIST of up to 512 I-V curves. Program up to 512 sets of points, where each set of points include curve parameters: V_{oc} , V_{mp} , I_{sc} , and I_{mp} . A dwell time of 30 ms to 65 seconds with 1 ms resolution can be specified and the E4360 SAS will stay (i.e. dwell) at the set point for the programmed dwell time value. Alternately, the LIST can be paced (advanced to the next set point) by a bus trigger or it can be paced by a trigger signal which enables synchronization of the LIST with an external event. Utilizing I-V curve lists speed up test execution by removing the computer I/O from the process and simplifies I-V curve change more easily simulating the solar array under various conditions.

Supplemental Characteristics

Interface Capabilities

GPIB, SCPI - 1993, IEEE 488.2 compliant interface
LXI Compliance, Core (only applies to units with LXI label on front panel)
USB 2.0, Requires Agilent IO Library version M.01.01 and up, or 14.0 and up
10/100 LAN, Requires Agilent IO Library version L.01.01 and up, or 14.0 and up
Built-in Web server, Requires Internet Explorer 5+ or Netscape 6.2+

Environmental Conditions

Operating environment: Indoor use, installation category II (for AC input), pollution degree 2

Temperature range: 0°C to 55°C (current is derated 1% per °C above 40°C ambient temperature)

Relative humidity: Up to 95%

Altitude: Up to 2000 meters

Storage temperature: -30°C to 70°C

LED statement: Any LEDs used in this product are Class 1 LEDs as per IEC 825-1

Calibration Interval

1 year

Regulatory Compliance

EMC:

Complies with the European EMC directive 89/336/EEC for Class A test and measurement products.

Complies with the Australian standard and carries the C-Tick mark.

This ISM device complies with Canadian ICES-001. Cet appareil ISM est conforme à la norme NMB-001 du Canada.

Electronic discharges greater than 1 kV near the I/O connectors may cause the unit to reset and require operator intervention.

Safety

Complies with the European Low Voltage Directive 73/23/EEC and carries the CE-marking.

This product also complies with the US and Canadian safety standards for test and measurement products.

Acoustic Noise Declaration

This statement is provided to comply with the requirements of the German Sound Emission Directive, from 18 January 1991.

Sound Pressure $L_p < 70$ dB(A), *At Operator Position, *Normal Operation, *According to EN 27779 (Type Test).

Schalldruckpegel $L_p < 70$ dB(A), *Am Arbeitsplatz, *Normaler Betrieb, *Nach EN 27779 (Typprüfung).

Output Terminal Isolation

±240 VDC (maximum from chassis ground)

Dimensions

Height 88.9 mm (3.5 in.)
Width 432.5 mm (17.03 in.)
Depth 633.9 mm (24.96 in.)

Weight

Mainframe with 2 modules:
38.4 lbs (17.6 kg)
Single output module:
7.2 lbs (3.3 kg)

Modular Solar Array Simulators: 1200 W (Continued)

Small Size

The Agilent E4360 provides up to 1200 W in a small 2U high, 19 inch wide package. It has side air vents (no top or bottom air vents) so other instruments can be mounted directly above or below it. This saves valuable rack space.

Ordering Information

Mainframe E4360A

Modular Solar Array Simulator
Main-frame, 1200 W, Holds up to 2 modules

Available options to the E4360A Mainframe

Opt 0L1 English printed users guide
(full documentation on CD-ROM)

Opt 908 Rack Mount Kit
Required for rack mounting. Standard
rack mount hardware will not work.

Opt 900 Power Cord, United Kingdom

Opt 901 Power Cord, Australia,
New Zealand

Opt 902 Power Cord, Europe

Opt 903 Power Cord, USA, Canada – 120 V

Opt 904 Power Cord, USA, Canada – 240 V

Opt 906 Power Cord, Switzerland

Opt 912 Power Cord, Denmark

Opt 917 Power Cord, India

Opt 918 Power Cord, Japan

Opt 919 Power Cord, Israel

Opt 920 Power Cord, Argentina

Opt 921 Power Cord, Chile

Opt 922 Power Cord, China

Opt 923 Power Cord, South Africa

Opt 927 Power Cord, Brazil, Philippine,
Thailand

Opt 931 Power Cord, Taiwan

Opt 932 Power Cord, Cambodia

Accessories

E4369A Filler Panel Kit Required
when you have only 1 module in a
mainframe. Each filler panel kit
contains one filler panel.

Modules

E4361A Solar Array Simulator DC
Module 60 V, 8.5 A, 500 W

E4362A Solar Array Simulator DC
Module 120 V, 5 A, 600 W

Options for the Modules

Opt 1A7 ISO 17025 Calibration Certificate

Opt A6J ANSI/NCSL Z540 Calibration
Certificate

Opt UK6 Commercial calibration with
test results data

Preconfigured Mainframes

E4367A Configured E4360A SAS
Mainframe with 2 E4361A Modules

E4368A Configured E4360A SAS
Mainframe with 2 E4362A Modules

Modular Solar Array Simulators: 1200 W (Continued)

Agilent Models: E4361A, E4362A, E4362A-J01, E4362A-J02

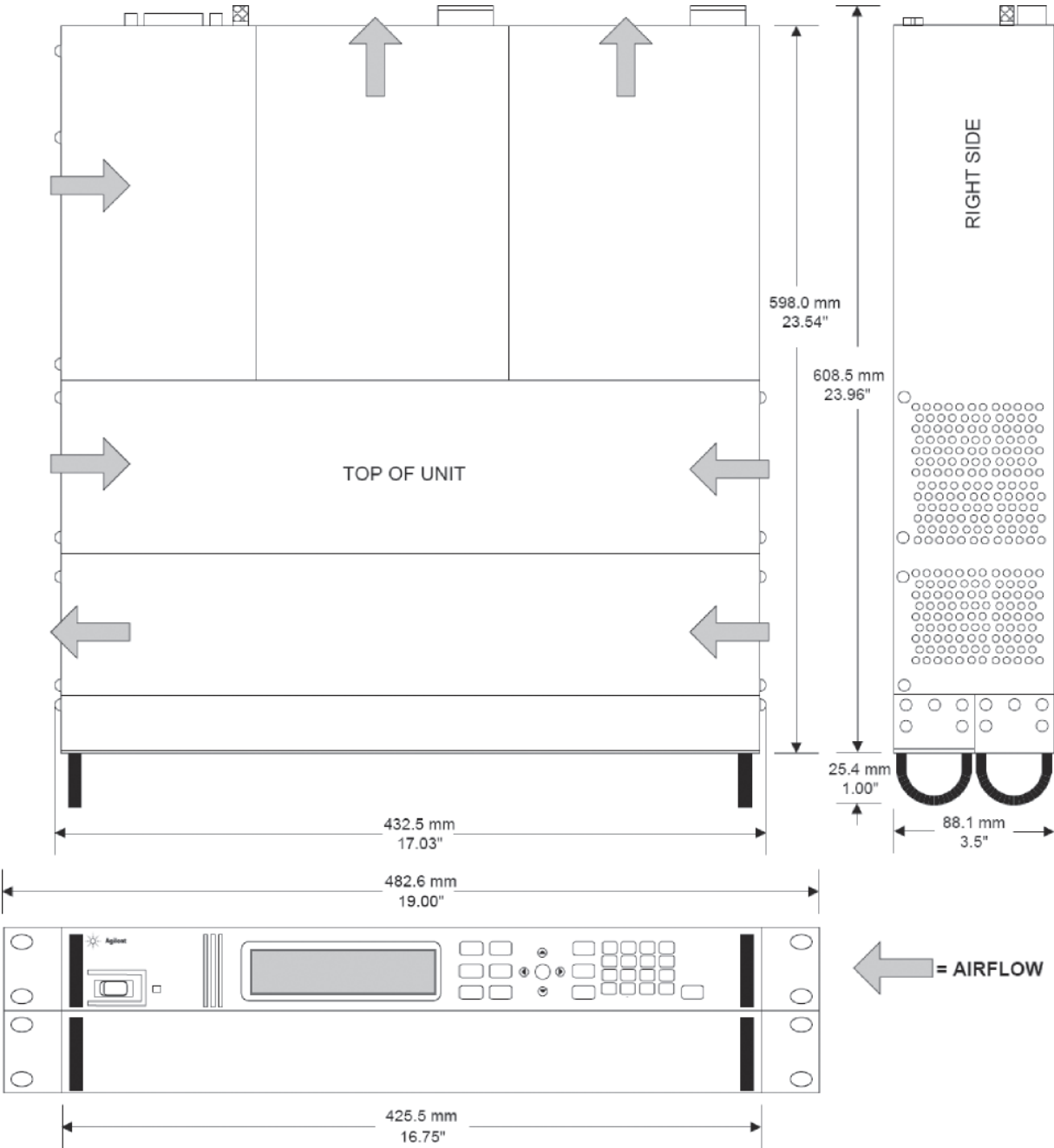

More detailed specifications at www.agilent.com/find/E4360



N6781A, N6782A, N6784A

Source Measure Units

N6780 Series Source/Measure Units

Seamless, dynamic measurements down to nA and μV (N6781A and N6782A only)
 Glitch-free operation – change sourcing or measurement ranges without any glitches
 Excellent transient response for stable output voltage with dynamic loads
 2 or 4-quadrant operation: use as a DC power supply or electronic load
 Fast modulation of DC output to create arbitrary waveforms up to 100 kHz
 Supported in any of the N6700 mainframes; ideally suited for N6705B mainframe

Advanced Measurement Features Offer More Design Insights

The N6781A and N6782A 2-quadrant SMUs offer advanced sourcing and measurement capabilities required to overcome test challenges associated with optimizing power consumption and maximizing battery life of battery-powered devices and their components.

The N6784A 4-quadrant SMU offers advanced sourcing and measurement capabilities in all four quadrants. It is designed to be a versatile tool for general purpose applications.

Seamless Dynamic Measurements (N6781A and N6782A only)

Seamless measurement ranging eliminates the challenges of measuring dynamic currents. With seamless measurement ranging, engineers can precisely measure dynamic currents without any glitches or disruptions to the measurement. As the current drawn by the DUT changes, the SMU automatically and instantaneously detects which current measurement range will return the most precise measurement and changes to that range seamlessly. When combined with the SMU's built-in 18-bit digitizer, seamless measurement ranging enables unprecedented effective vertical resolution of approximately 28-bits. This provides unrivaled productivity gains

Mainframe Characteristics

N6705B DC Power Analyzer

Configuration	Flexible/reconfigurable
Available slots	4 - mainframe accepts up to 4 DC power modules
Power	600 W total DC module output power
Instrument control	GPIB, USB, LAN (LXI Core Compliant)

SMU Module Specifications

	N6781A	N6782A	N6784A
DC output ratings			
Voltage	+20 V	+20 V	± 20 V
Current (derated 1% per $^{\circ}\text{C}$ above 30°C)	± 3 A	± 3 A	± 3 A
Power	20 W	20 W	20 W
Output voltage ripple & noise (PARD) (from 20 Hz - 20 MHz, at full load)			
CV peak-to-peak	12 mV	12 mV	12 mV
CV rms	1.2 mV	1.2 mV	1.2 mV
Load effect (load regulation) (For any load change, based on a load lead drop 1.0 V. The load lead drop reduces the maximum available voltage at the load.)			
Voltage, 20 V, 6 V, 600 mV ranges	700 μV	700 μV	700 μV
Current, 3 A, 1 A, & 300 mA ranges	100 μA	100 μA	100 μA
Source effect (line regulation)			
Voltage	300 μV	300 μV	300 μV
Current	60 μA	60 μA	60 μA
Programming accuracy (At $23^{\circ}\text{C} \pm 5^{\circ}\text{C}$ after 30 min. warm-up. Applies from minimum to maximum programming range at any load.)			
Voltage, 20 V range	0.025% + 1.8 mV	1.8 mV	1.8 mV
Voltage, 6 V range	0.025% + 600 μV	600 μV	600 μV
Voltage, 600 mV range	0.025% + 200 μV	200 μV	200 μV
Current, 3 A & 1 A range	0.04% + 300 μA	300 μA	300 μA
Current, 300 mA range	0.03% + 150 μA	150 μA	N/A

More detailed specifications at www.agilent.com/find/N6781A
www.agilent.com/find/N6782A
www.agilent.com/find/N6784A

Source Measure Units

N6780 Series Source/Measure Units (Continued)

SMU Module Specifications	N6781A	N6782A	N6784A
---------------------------	--------	--------	--------

and insights into power consumption by enabling engineers to see the complete current waveform they have never seen before, from nA to A, in one pass and one picture.

Designed for both R&D and Automated Test Environments (ATE)

The new SMUs are a part of the N6700 modular power system, which consists of the N6700 low-profile mainframes for ATE and the N6705 DC power analyzer mainframe for R&D. The product family has four mainframes and more than 30 DC power modules to choose from providing a complete spectrum of solutions, from R&D through design validation and manufacturing.

Key features

Apply to all models unless otherwise noted

- Seamless, dynamic measurements down to nA and μV (N6781A and N6782A only)
- Glitch-free operation – change sourcing ranges or measurement ranges without any glitches
- Four current programming ranges – precisely source current down to μA (N6784A only)
- Excellent transient response for stable output voltage with dynamic loads
- 2-quadrant operation – use as an advanced power supply or electronic load (N6781A and N6782A only)
- 4-quadrant operation – use as an advanced bipolar power supply or bipolar electronic load (N6784A only)
- Stable operation with capacitive loads up to 150 μF

Programming accuracy

(At 23 °C ± 5 °C after 30 min. warm-up. Applies from minimum to maximum programming range at any load.)

Current, 100 mA range	0.03% +	N/A	N/A	12 μA
Current, 10 mA range	0.025% +	N/A	N/A	5 μA
Resistance (in 20 V output range)	0.1% +	3 m Ω	N/A	N/A
Resistance (in 6 V output range)	0.1% +	1.5 m Ω	N/A	N/A

Measurement accuracy

(at 23 °C ± 5 °C)

Voltage, 20 V range	0.025% +	1.2 mV	1.2 mV	1.2 mV
Voltage, 1 V range	0.025% +	75 μV	75 μV	75 μV
Voltage, 100 mV range	0.025% +	50 μV	50 μV	50 μV
Current, 3 A range	0.03% +	250 μA	250 μA	250 μA
Current, 100 mA range	0.025% +	10 μA	10 μA	10 μA
Current, 1 mA range	0.025% +	100 nA	100 nA	100 nA
Current, 10 μA range	0.025% +	8 nA	8 nA	8 nA

Load transient response time – voltage priority

In the 20 V output range: the time to recover to within the settling band for a load change from 0.1 A to 0.5 A.

In the 6 V output range: the time to recover to within the settling band for a load change from 0.1 A to 1.5 A.

Voltage settling band (20 V output range)	± 10 mV	± 10 mV	± 10 mV
Voltage settling band (6 V output range)	± 20 mV	± 20 mV	± 20 mV
Recovery time	≤ 35 μs	≤ 35 μs	≤ 35 μs

- High-speed output can slew at 10 V per μs into a resistive load
- Fast modulation of DC output – create arbitrary waveforms up to 100 kHz (sine) into a resistive load
- High-speed digitized measurements – capture/view the power consumption of the DUT up to every 5 μs with built-in 200 kHz digitizer
- Auxiliary voltage measurement input for battery run down test (N6781A only)
- Programmable output resistance from -40 m Ω to +1 Ω to simulate internal resistance of a battery (N6781A only)

More detailed specifications at www.agilent.com/find/N6781A
www.agilent.com/find/N6782A
www.agilent.com/find/N6784A

Source Measure Units

N6780 Series Source/Measure Units (Continued)

Applications

N6781A SMU is tuned for battery drain analysis of any and all battery powered devices including e-Book readers, MP3 players, wireless mice, and mobile phones.

N6782A SMU is tuned for functional tests of devices such as DC/DC converters, PMUs, PMICs, and power amplifiers.

N6784A SMU is designed to be a versatile tool for general-purpose applications in automated test systems or on an R&D bench.

14585A Control and Analysis Software

The software for the DC power analyzer compliments the front panel of the N6705 mainframe, offering advanced functionality and PC control. It is a flexible R&D tool for any application. When used to control an N6781A SMU, it can be used for advanced battery drain analysis applications.

- Control and analyze data from up to four N6705 DC power analyzers and any installed modules at once
- Easily create complex waveforms to stimulate or load down a DUT by inputting a formula, choosing from built-in, or importing waveform data.
- Data log measurements directly to a PC
- Perform statistical analysis of power consumption

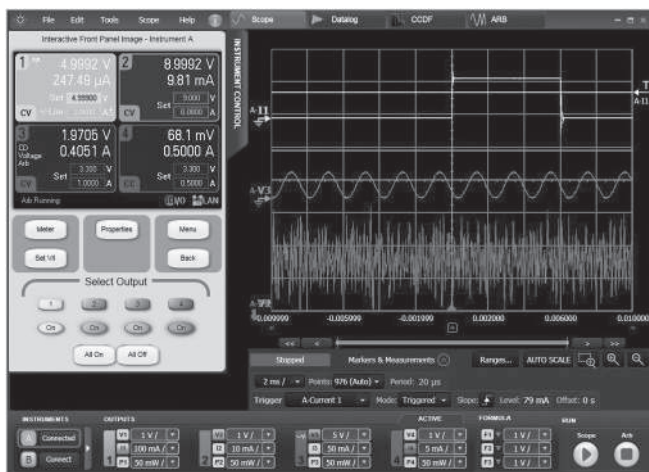

Ordering information

N6781A 2-Quadrant Source/Measure Unit for Battery Drain Analysis

N6782A 2-Quadrant Source/Measure Unit for Functional Test

N6784A 4-Quadrant General Purpose Source/Measure Unit

N6705B-056 Software License to Control N6705A/B with 14585A Control and Analysis Software (Option to the N6705B when ordered new)

N6705U-056 Upgrade an N6705A/B DC Power Analyzer with 14585A Software License

More detailed specifications at www.agilent.com/find/N6781A
www.agilent.com/find/N6782A
www.agilent.com/find/N6784A



B2900A

Source Measure Units B2900A Series Precision Source/Measure Units

Innovative bench-top SMU provides superior performance and rapid measurement results
 Test up to 210 V and 3 A (DC) or 10.5 A (pulsed) with a single instrument
 Source and measurement resolution down to 10 fA and 100 nV
 Innovative GUI facilitates fast bench-top test, debug and characterization
 Ultrafast throughput lowers cost-of-test

Specifications (at 0° to 55°C unless otherwise specified)

The Agilent B2900A Series of Precision Source/Measure Units are compact and cost-effective bench-top Source/Measure Units (SMUs) with the capability to source and measure both voltage and current. These capabilities make the B2900A series ideal for a wide variety of IV (current versus voltage) measurement tasks that require both high resolution and accuracy.

The B2900A SMUs can source and measure voltages of ±210 V and currents of ±3 A (DC) or ±10.5 A (pulsed). This versatility allows you to standardize on a single SMU model and minimize support costs.

The B2901A and B2902A possess 100 fA and 100 nV measurement resolution and 1 pA and 1 µV sourcing resolution. The B2911A and B2912A precision versions possess 10 fA and 100 nV of resolution for both measurement and sourcing. All members of the Agilent B2900A series support popular banana jack style inputs for cost effective and flexible connectivity; for low-current measurements below 1 nA, banana jack to triaxial adapters are available.

The B2900A front panel has many features that make interactive use fast and friendly. The 4.3" color display supports both graphical

	B2901A	B2902A	B2911A	B2912A
Number of channels	1	2	1	2
Max Output				
Voltage	210 V	210 V	210 V	210 V
Current	DC 3.03 A	3.03 A	3.03 A	3.03 A
	Pulsed 10.5 A	10.5 A	10.5 A	10.5 A
Power	31.8 W	31.8 W	31.8 W	31.8 W
Source				
Max digits	Digits 5½	5½	6½	6½
Min resolution	Voltage 1 µV	1 µV	100 nV	100 nV
	Current 1 pA	1 pA	10 fA	10 fA
Measurement				
Max digits	Digits 6½	6½	6½	6½
Min resolution	Voltage 100 nV	100 nV	100 nV	100 nV
	Current 100 fA	100 fA	10 fA	10 fA
Min programmable interval for list sweep/AWG waveform (Max number of steps/s)	20 µs (50 k steps/s)	20 µs (50 k steps/s)	20 µs (100 k steps/s)	20 µs (100 k steps/s)
Min trigger interval for digitizing (Max sample rate)	20 µs (50,000 pts/s)	20 µs (50,000 pts/s)	10 µs (100,000 pts/s)	10 µs (100,000 pts/s)
View Mode				
Single view	X	X	X	X
Dual view		X		X
Graph view	X	X	X	X
Roll view			X	X

and numerical view modes, and enables rapid test setup and results checking.

The innovative graphical user interfaces, such as single view, dual view, graph view, roll view and zoom, dramatically improve usability and productivity of bench-top tests, debug and characterization.

The Agilent B2900A series is also well-suited for production test. It can achieve excellent accuracy and repeatability at even short integration times. The B2900A series possesses the fastest measurement speed of any SMU in its class.

Source Measure Units

B2900A Series Precision Source/Measure Units (Continued)

Graphical User Interface (GUI) image:

Single view mode

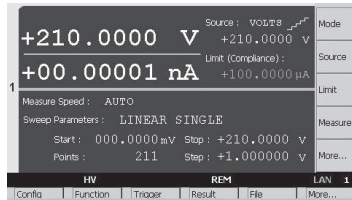

Dual view mode

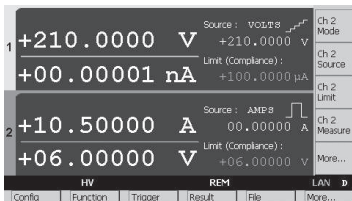

Graph view mode

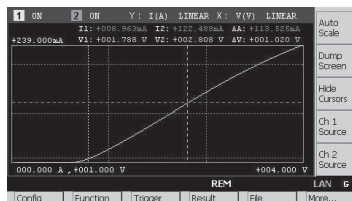

Roll view mode

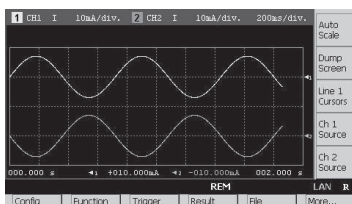

Key features and benefits:

- Integration of 4-quadrant sourcing and measuring capabilities:** Easily and accurately measure current and voltage using a single instrument without the need to manually change any connections.
- Measurement range: ± 210 V, ± 3 A (DC), ± 10.5 A (pulsed):** A single SMU product covers both high voltage and high current measurement needs, allowing for more standardization and simplifying inventory and support concerns.
- Source and measurement resolution down to 10 fA and 100 nV:** Can make low-level measurements using a low-cost bench-top SMU that were previously only possible using a more expensive semiconductor device analyzer.
- User-friendly front panel GUI with 4.3 inch color LCD display supports both graphical and numerical view modes:** Can quickly and easily perform measurements and display data on the front panel, thereby greatly speeding up interactive test, characterization and debug operations.
- 10 microsecond digitizing capability:** Can capture low frequency phenomena in addition to DC characteristics.
- Free PC-based control software:** Can make measurements remotely from a PC without the need to program.

- Supports both conventional and default SCPI commands:** Conventional SCPI commands provide some compatibility with older SMU code (such as Keithley 2400 series) to minimize code conversion work. Default SCPI commands support advanced B2900A series features.
- Small form factor with USB2.0, LAN, GPIB and digital I/O interfaces:** Easy integration into rack and stack systems.

Key B2900A series accessories:

N1294A-001 Banana - Triax Adapter for 2-wire (non Kelvin) connection

N1294A-002 Banana - Triax Adapter for 4-wire (Kelvin) connection

N1294A-011 Interlock cable for 16442B (1.5 m)

N1294A-012 Interlock cable for 16442B (3.0 m)

N1295A Device/Component Test Fixture

Ordering information:

B2901A Precision Source/Measure Unit, 1ch, 100 fA, 210 V, 3 A DC/10.5 A pulse

B2902A Precision Source/Measure Unit, 2ch, 100 fA, 210 V, 3 A DC/10.5 A pulse

B2911A Precision Source/Measure Unit, 1ch, 10 fA, 210 V, 3 A DC/10.5 A pulse

B2912A Precision Source/Measure Unit, 2ch, 10 fA, 210 V, 3 A DC/10.5 A pulse



U2700

Source Measure Units

U2700 Series USB Modular Source Measure Units

- 3-Channel source measure unit
- 4-Quadrant (± 20 V)
- High current sensitivity of 100 pA with 16 bit resolution
- 0.1% basic accuracy
- Low current measurement capability down to nA levels
- Voltage and current programming/readback
- High-speed USB 2.0, USBTMC-USB488 standard
(compatible with Microsoft® Windows® operating systems only.)
- Standalone and modular capabilities

Specifications

(at 0° to 55°C unless otherwise specified)

	U2722A	U2723A	
Number of outputs	3	3	
Output ratings (at 0 °C to 50 °C)			
Voltage	-20 V to 20 V	-20 V to 20 V	
Current	-120 mA to 120 mA	-120 mA to 120 mA	
Performance specification			
Voltage programming 12 months (at 25 °C \pm 3 °C), \pm (% of output + offset)			
Accuracy ¹	Range ± 2 V	0.075% + 1.5 mV	0.075% + 1.5 mV
	Range ± 20 V	0.05% + 10 mV	0.05% + 10 mV
Resolution	Range ± 2 V	0.1 mV	0.1 mV
	Range ± 20 V	1 mV	1 mV
Current programming 12 months (at 25 °C \pm 3 °C), \pm (% of output + offset)			
Accuracy ¹	Range ± 1 μ A	0.085% + 0.85 nA	0.085% + 0.85 nA
	Range ± 10 μ A	0.085% + 8.5 nA	0.085% + 8.5 nA
	Range ± 100 μ A	0.075% + 75 nA	0.075% + 75 nA
	Range ± 1 mA	0.075% + 750 nA	0.075% + 750 nA
	Range ± 10 mA	0.075% + 7.5 μ A	0.075% + 7.5 μ A
	Range ± 120 mA	0.1% + 100 μ A	0.1% + 100 μ A
Resolution	Range ± 1 μ A	100 pA	100 pA
	Range ± 10 μ A	1 nA	1 nA
	Range ± 100 μ A	10 nA	10 nA
	Range ± 1 mA	100 nA	100 nA
	Range ± 10 mA	1 μ A	1 μ A
	Range ± 120 mA	20 μ A	20 μ A

¹ Accuracy measurements are based on NPLC 10.

Three-channel, four-quadrant (± 20 V, ± 120 mA)

The U2722A/U2723A three-channel SMU is a versatile device that allows you to perform sweep and measurement from different operating regions without needing extra configurations. The four quadrant operation makes the U2722A/U2723A SMU well suited for a wide range of test applications, including leakage measurement, solar cell measurement, forward/reverse voltage and IV curve tracing.

Increase the efficiency of your tests

With a high measurement sensitivity of 100 pA at 16-bit resolution for pico-level measurement and 0.1% accuracy, the U2722A/U2723A USB modular source measure unit provides more detailed and accurate analysis and measurement results. U2722A/U2723A supports SCPI and IVI-COM. The SMU is compatible with a wide range of Application Development Environments, minimizing your work time and increasing your software options. Save time and effort with the bundled Agilent Measurement Manager (AMM) software, which converts SCPI commands into snippets of VEE, VB, C++ and C# code with the command logger function.

More detailed specifications at www.agilent.com/find/U2722A
www.agilent.com/find/U2723A

Source Measure Units

U2700A Series USB Modular Source Measure Units (Continued)

Specifications

(at 0° to 55°C unless otherwise specified)

U2722A

U2723A

Pre-define test configurations and execute commands automatically

The U2723A USB modular source measure unit provides an embedded test script to help you pre-define test configurations or duplicate tests easily without spending too much time on programming. Each channel in the U2723A USB modular SMU is allocated two memory lists, each capable of storing up to 200 commands and results individually. Stored commands in active memory will be executed accordingly while the measurement results obtained are automatically stored in the result buffer.

Supplemental characteristics

Remote interface:

- Hi-Speed USB 2.0*
- USBTMC-USB488¹

Power consumption:

- +12 VDC, 3 A maximum
- Isolated ELV supply source

Operating environment:

- Operating temperature from 0 °C to +50 °C
- Relative humidity at 20% to 85% RH (non-condensing)
- Altitude up to 2000 meters
- Pollution Degree 2
- For indoor use only

Storage compliance: -20 °C to 70 °C

Safety compliance

Certified with:

- IEC 61010-1:2001/EN 61010-1:2001 (2nd Edition)
- USA: ANSI/UL 61010-1:2004
- Canada: CSA C22.2 No.61010-1:2004

EMC compliance:

- IEC 61326-1:2005/EN61326-1:2006
- Canada: ICES-001:2004
- Australia/New Zealand: AS/NZS CISPR 11:2004

¹ Compatible with Microsoft® Windows® operating systems only.

* If remote connections are necessary, a E5813A USB/LAN hub can be used. Please go to the product's user guide for more information.

Performance specification (continued)

Voltage readback 12 months (over USB with respect to the actual output at 25 °C ± 3 °C), ±(% of output + offset)

Accuracy ¹	Range ±2 V	0.075% + 1.5 mV	0.075% + 1.5 mV
	Range ±20 V	0.05% + 10 mV	0.05% + 10 mV
Resolution	Range ±2 V	0.1 mV	0.1 mV
	Range ±20 V	1 mV	1 mV

Current readback 12 months (over USB with respect to the actual output at 25 °C ± 3 °C), ±(% of output + offset)

Accuracy ¹	Range ±1 µA	0.085% + 0.85 nA	0.085% + 0.85 nA
	Range ±10 µA	0.085% + 8.5 nA	0.085% + 8.5 nA
	Range ±100 µA	0.075% + 75 nA	0.075% + 75 nA
	Range ±1 mA	0.075% + 750 nA	0.075% + 750 nA
	Range ±10 mA	0.075% + 7.5 µA	0.075% + 7.5 µA
	Range ±120 mA	0.1% + 100 µA	0.1% + 100 µA
Resolution	Range ±1 µA	100 pA	100 pA
	Range ±10 µA	1 nA	1 nA
	Range ±100 µA	10 nA	10 nA
	Range ±1 mA	100 nA	100 nA
	Range ±10 mA	1 µA	1 µA
	Range ±120 mA	20 µA	20 µA

Rise/fall time (ms)²

For resistive measurement ²	±1 µA	170.0	15.0
	±10 µA	18.0	5.0
	±100 µA	6.0	1.0
	±1 mA	1.0	1.0
	±10 mA	1.0	1.0
	±120 mA	1.0	1.0

¹ Accuracy measurements are based on NPLC 10.

² Drive 50% of 1 V or 10 V output with a resistive load. Rise time is from 10% to 90% of program voltage change at maximum current. Fall time is from 90% to 10% of program voltage change at maximum current.

More detailed specifications at www.agilent.com/find/U2722A
www.agilent.com/find/U2723A

Source Measure Units

U2700A Series USB Modular Source Measure Units (Continued)

Supplemental characteristics (continued)

Shock and vibration:

Tested to IEC/EN 60068-2

IO connector: Output connectors

Dimension (W × D × H):

Module:

- 120 mm x 183 mm x 66 mm (with bumpers)
- 105 mm x 175 mm x 50 mm (without bumpers)

Weight:

- 700 g (with bumpers)
- 650 g (without bumpers)

Warranty:

- Three years for U2722A/U2723A
- Three months for standard shipped accessories

Front

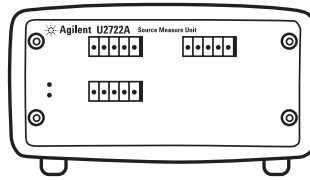

Back

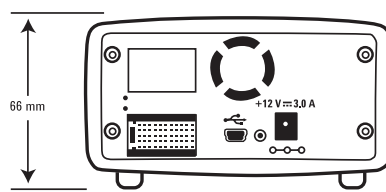

Top

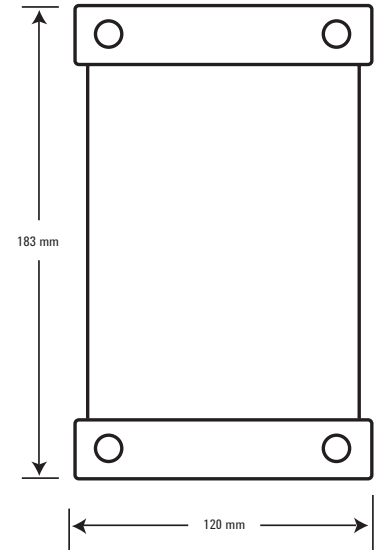

View IV curves in minutes with U2942A Parametric Measurement Manager Pro

If you are looking for a basic yet complete IV curve tracer solution for component devices, then the new Agilent U2722P and U2723P Parametric Measurement solution is up to the task. The bundled U2942A software works with the U2722A/U2723A USB modular source measure unit to analyze discrete semiconductor, then plots, and displays the results in an IV curve.

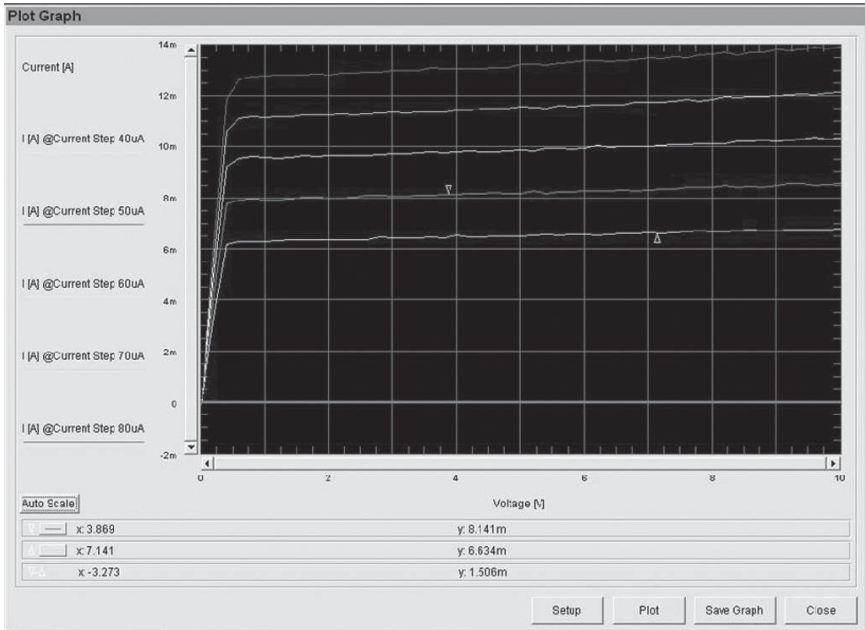

More detailed specifications at www.agilent.com/find/U2722A
www.agilent.com/find/U2723A

Source Measure Units

U2700A Series USB Modular Source Measure Units (Continued)

Optional accessories for the U2700 Series

U2921A-101 USB secure cable, 2 m

Optional accessories for the U2941A parametric test fixture

U2941A-101 Pin plug-to-pin plug cable, black

U2941A-102 Pin plug-to-pin plug cable, red

U2941A-103 Pin plug-to-pin plug cable, blue

U2941A-104 Pin plug-to-miniature clip cables, black

U2941A-105 Pin plug-to-miniature clip cables, red

U2941A-106 Pin plug-to-miniature clip cables, blue

U2941A-107 BNC to two-wire, 1 m

U2941A-201 Assembly PTFE plate
• Insulation board with minimal leakage current; suitable for extremely low-current measurement

U2941A-202 28-pin dual-in-line package (DIP) socket module
• Lever actuated zero insertion force (ZIF) socket

U2941A-203 0.1-inch universal socket module
• 0.1-inch pitch; suitable for virtually any device such as components, DIP IC or small scale circuit

U2941A-204 0.075-inch universal socket module
• 0.075-inch pitch; suitable for virtually any device such as components, DIP IC or small scale circuit

U2941A-205 0.05-inch universal socket module
• 0.05-inch pitch; suitable for any device such as components, DIP IC or small scale circuit

Ordering Information

U2722A USB modular source measure unit

U2723A USB modular source measure unit with embedded test scripts

U2941A Parametric test fixture, shipped with:
• Assembly PTFE plate
• 28-pin dual-in-line package (DIP) socket module
• 0.1-inch universal socket module
• 0.075-inch universal socket module
• 0.05-inch universal socket module
• Pin plug-topin plug cables, black (4 pcs)
• Pin plug-topin plug cables, red (4 pcs)
• Pin plug-topin plug cables, blue (4 pcs)
• Pin plug-to-miniature clip cables, black (4 pcs)
• Pin plug-to-miniature clip cables, red (4 pcs)
• Pin plug-to-miniature clip cables, blue (4 pcs)
• PCB jumper pin
• BNC to two-wire cable, 1 m (3 pcs)
• Agilent Parametric Measurement Manager CD (includes installation and operation guide)

U2942A Parametric Measurement Manager Pro software

U2722P* U2722A USB modular source measure unit and U2942A Parametric Measurement Manager Pro bundle

U2723P* U2723A USB modular source measure unit and U2942A Parametric Measurement Manager Pro bundle

* Only available in Europe and Asia (excluding Japan)

Source Measure Units

E5260A 8-Slot High Speed Measurement Mainframe

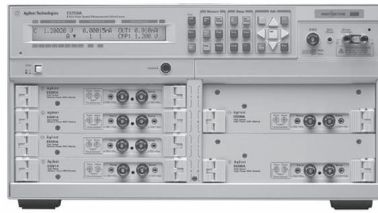

E5260A

Perform high-speed, DC parametric measurements
 Eight slots for plug-in modules
 Code compatible with 4142B

Fast measurement that lowers cost-of-test

The fast measurement speed and modular nature of the E5260A makes it an ideal choice for high-speed production test. For technologically advanced devices of today and tomorrow, the Agilent E5260A lowers your cost-of-test with a high-speed parametric test solution for semiconductor, RFIC, and optical component testing. Based on well-proven Agilent 4070 Series system technology, the E5260A provides superior measurement throughput that is several times faster than earlier products such as the Agilent 4142B. The instrument is modular, which enables customization now and provides for future expansion as requirements change. A number of innovative design elements help to improve the efficiency of complex testing, such as expanded program memory to accelerate the measurement process, and 16 digital I/O lines for sophisticated triggering requirements. Moreover, historically encountered power limitations on the instrument mainframe (such as often occur with the 4142B) have been eliminated.

Mainframe Characteristics	E5260A 8-Slot Precision Measurement Mainframe
Available slots	8
Ground Unit (GNDU) Sink Capability	4.0 A
Instrument control	GPIB
External trigger inputs/outputs	1 BNC trigger in; 1 BNC trigger out; 8 programmable trigger in/out

Module Selection Guide	E5290A High Speed HPSMU	E5291A High Speed MPSMU
Required slots	2	1
Maximum force voltage	± 200 V	± 100 V
Maximum force current	± 1 A	± 200 mA
Voltage measurement resolution	100 µV	100 µV
Current measurement resolution	5 pA	5 pA

Modular design enables customization now and provides for future expansion

The flexible, modular configuration has eight slots available for plug-in modules. Currently available source/monitor unit (SMU) types are a medium power SMU (MPSMU) – requiring one slot – and a high-power SMU (HPSMU) – requiring two slots. Easily expand into the E5260A from your current environment because commands developed on the 4142B can also run on the new system.

High measurement speed

The E5260A performs DC measurements of current and voltage through measurement speeds of SMUs that are 2-3 times faster than that of the Agilent 4142B.

Innovative design elements support complex testing and improve efficiency

Program memory has been greatly enhanced, with storage capacity for up to 40,000 command lines, which accelerates the measurement process. A fast and flexible advanced triggering

More detailed specifications at www.agilent.com/find/E5260A

Source Measure Units

E5260A 8-Slot High Speed Measurement Mainframe (Continued)

scheme, based upon 16 digital I/O lines, in addition to the BNC trigger-in & trigger-out connectors, is ideal for sophisticated triggering requirements. Also, trigger signals are routed through hardware rather than firmware, resulting in the fastest instrument response possible. To enable parallel testing, each SMU is equipped with its own analog-to-digital converter (ADC) therefore no bottlenecks. Engineers can perform and report spot measurements easily via a simple front-panel interface, without programming. In addition, you can use the same user interface to view other items of interest, such as error messages when debugging the instrument performance under automated control.

Designed to withstand heavyweight power demands

Alternative testing solutions may present power limitations, but not the E5260A. No matter which type or how many modules are installed into the E5260A mainframe, all installed modules can output maximum voltage or current at the same time. For example, if 4 HPSMUs are installed in the E5260A, then each HPSMU can output 1 Amp. A 4.0 Amp ground unit is resident in the instrument mainframe to ensure that you can sink the current output of these 4 HPSMUs without having to worry about resistive ground rise issues. In addition, each MPSMU can source and sink up to 200 mA each, which is twice the capability typically found in a MPSMU.

Key features and benefits:

- **Eight module slots:** Flexibility now and expandability in the future
- **SMUs that measure several times faster than 4142B SMUs:** Faster test times and improved throughput, resulting in a lower cost-of-test
- **Code compatible with the 4142B:** Replace current 4142Bs with the E5260A and enjoy a large throughput improvement with only minimal test code modification
- **6 digital I/O lines for instrument triggering in addition to BNC trigger-in & trigger-out connectors:** Sophisticated triggering schemes involving multiple instruments can easily be created
- **All trigger signals are processed via hardware rather than firmware:** Fastest possible trigger response from the instrument
- **Front panel control:** Can conveniently perform and report spot measurements via a simple front-panel interface, without programming. View other items of interest, such as error messages, valuable when debugging the instrument performance under automated control.
- **When 4 HPSMUs are installed then each HPSMU can output 1 A:** No power restrictions; no need to think about mainframe power restrictions when developing applications
- **4.0 Amp Ground unit (GNDU):** Sink the current output of 4 HPSMUs without worrying about resistive ground rise issues

Key E5260A accessories and cables:

- N1254A-100** Ground unit to Kelvin adapter
- 16442B** Test fixture
- 16494A-001/002** Triaxial cable (1.5 meter/3 meter)

Ordering information:

The E5260A does not have any base configuration. All desired modules, accessories, and cables must be specified at the time of order.

Note: Since the E5260A is a modular product, you can add new modules to it at any time after initial purchase as long as you have open slots.

Source Measure Units

E5262A 2-Channel (Medium Power, Medium Power) High Speed Source Monitor Unit



E5262A

Perform high-speed, DC parametric measurements
Fixed-configuration dual SMU instrument

Fast measurement that lowers cost-of-test

The fast measurement speed of the E5262A makes it an ideal choice for high-speed production test in situations requiring only one or two SMUs. Based on Agilent 4070 Series system technology, the Agilent E5262A lowers your cost-of-test with a high-speed parametric test solution for semiconductor, RFIC, and optical component testing. Two MPSMU modules and a ground unit are included in the E5262A, providing just enough test capability for many component-testing needs. The E5262A provides superior measurement throughput, several times faster than earlier products such as the Agilent 4142B. A number of innovative design elements help to improve the efficiency of complex testing, such as expanded program memory to accelerate the measurement process, and 16 digital I/O lines for sophisticated triggering requirements.

High measurement speed

The E5262A performs DC measurements of current and voltage and achieves measurement speeds that are 2-3 times faster than that of the Agilent 4142B. Easily migrate from your current 4142B test environment to the E5262A because programs developed for the 4142B can run on the E5262A with only minor modification.

Mainframe Characteristics

E5262A 2-Channel High Speed Source Monitor Unit

Available slots	Two channel (2X MPSMU) configuration
Ground Unit (GNDU) Sink Capability	2.2 A
Instrument control	GPIO
External trigger inputs/outputs	1 BNC trigger in; 1 BNC trigger out; 8 programmable trigger in/out

Included Module

E5291A High Speed MPSMU

Maximum force voltage	±100 V
Maximum force current	± 200 mA
Voltage measurement resolution	100 µV
Current measurement resolution	5 pA

Innovative design elements support complex testing and improve efficiency

Program memory has been greatly enhanced, with storage capacity for up to 40,000 command lines, which accelerates the measurement process. A fast and flexible advanced triggering scheme, based upon 16 digital I/O lines, in addition to the BNC trigger-in & trigger-out connectors, is ideal for sophisticated triggering requirements. Also, trigger signals are routed through hardware rather than firmware, resulting in the fastest instrument response possible. To enable parallel testing, each SMU is equipped with its own analog-to-digital converter (ADC) therefore no bottlenecks. Engineers can perform

and report spot measurements easily via a simple front-panel interface, without programming. In addition, you can use the same user interface to view other items of interest, such as error messages when debugging the instrument performance under automated control.

Cost-effective solution for simple parametric test requirements

Many component measurements, such as laser diode and photo diode characterization, require only one or two source/monitor units. The configuration of the E5262A provides the ideal balance of functionality for such tasks at an affordable price.

More detailed specifications at www.agilent.com/find/E5262A

Source Measure Units

E5262A 2-Channel High Speed Source Monitor Unit (Continued)

Key features and benefits:

- **Two MPSMU configuration:**
Cost effective solution provides just enough test capability
- **SMUs that measure several times faster than 4142B SMUs:**
Faster test times and improved throughput, resulting in a lower cost-of-test
- **Code compatible with the 4142B:**
Replace current 4142Bs with the E5262A and enjoy a large throughput improvement with only minimal test code modification
- **16 digital I/O lines for instrument triggering in addition to BNC trigger-in & trigger-out connectors:**
Sophisticated triggering schemes involving multiple instruments can easily be created
- **All trigger signals are processed via hardware rather than firmware:**
Fastest possible trigger response from the instrument
- **Front panel control:** Can conveniently perform and report spot measurements via a simple front-panel interface, without programming. View other items of interest, such as error messages, valuable when debugging the instrument performance under automated control.

Accessories and cables:

- N1254A-100** Ground unit to Kelvin adapter
- 16442B** Test fixture
- 16494A-001/002** Triaxial cable (1.5 meter/3 meter)

Ordering information:

The E5262A is a fixed-configuration product; there are no options or required accessories.

Source Measure Units

E5263A 2-Channel (High Power, Medium Power) High Speed Source Monitor Unit



E5263A

Perform high-speed, DC parametric measurements
Fixed-configuration dual SMU instrument

Fast measurement that lowers cost-of-test

The fast measurement speed of the E5263A makes it an ideal choice for high-speed production test in situations requiring only one or two SMUs. Based on Agilent 4070 Series system technology, the Agilent E5263A lowers your cost-of-test with a high-speed parametric test solution for semiconductor, RFIC, and optical component testing. HPSMU and MPSMU modules and a ground unit are included in the E5263A, providing just enough test capability for many component-testing needs. The E5263A provides superior measurement throughput, several times faster than earlier products such as the Agilent 4142B. A number of innovative design elements help to improve the efficiency of complex testing, such as expanded program memory to accelerate the measurement process, and 16 digital I/O lines for sophisticated triggering requirements.

High measurement speed

The E5263A performs DC measurements of current and voltage and achieves measurement speeds that are 2-3 times faster than that of the Agilent 4142B. Easily migrate from your current 4142B test environment to the E5263A because programs developed for the 4142B can run on the E5263A with only minor modification.

Mainframe Characteristics

E5263A 2-Channel High Speed Source Monitor Unit

Available slots	Two channel (HPSMU and MPSMU) configuration
Ground Unit (GNDU) Sink Capability	2.2 A
Instrument control	GPIO
External trigger inputs/outputs	1 BNC trigger in; 1 BNC trigger out; 8 programmable trigger in/out

Included Module

E5290A High Speed HPSMU

E5291A High Speed MPSMU

Maximum force voltage	±200 V	±100 V
Maximum force current	±1 A	±200 mA
Voltage measurement resolution	100 µV	100 µV
Current measurement resolution	5 pA	5 pA

Innovative design elements support complex testing and improve efficiency

Program memory has been greatly enhanced, with storage capacity for up to 40,000 command lines, which accelerates the measurement process. A fast and flexible advanced triggering scheme, based upon 16 digital I/O lines, in addition to the BNC trigger-in & trigger-out connectors, is ideal for sophisticated triggering requirements. Also, trigger signals are routed through hardware rather than firmware, resulting in the fastest instrument response possible. To enable parallel testing, each SMU is equipped with its own analog-to-digital converter (ADC) therefore no bottlenecks. Engineers can perform

and report spot measurements easily via a simple front-panel interface, without programming. In addition, you can use the same user interface to view other items of interest, such as error messages when debugging the instrument performance under automated control.

Cost-effective solution for simple parametric test requirements

Many component measurements, such as laser diode and photo diode characterization, require only one or two source/monitor units. The configuration of the E5263A provides the ideal balance of functionality for such tasks at an affordable price.

More detailed specifications at www.agilent.com/find/E5263A

Source Measure Units

E5263A 2-Channel High Speed Source Monitor Unit (Continued)

Key features and benefits:

- **One HPSMU and one MPSMU configuration:** Cost effective solution provides just enough test capability
- **SMUs that measure several times faster than 4142B SMUs:** Faster test times and improved throughput, resulting in a lower cost-of-test
- **Code compatible with the 4142B:** Replace current 4142Bs with the E5263A and enjoy a large throughput improvement with only minimal test code modification
- **16 digital I/O lines for instrument triggering in addition to BNC trigger-in & trigger-out connectors:** Sophisticated triggering schemes involving multiple instruments can easily be created
- **All trigger signals are processed via hardware rather than firmware:** Fastest possible trigger response from the instrument
- **Front panel control:** Can conveniently perform and report spot measurements via a simple front-panel interface, without programming. View other items of interest, such as error messages, valuable when debugging the instrument performance under automated control.

Accessories and cables:

- N1254A-100** Ground unit to Kelvin adapter
- 16442B** Test fixture
- 16494A-001/002** Triaxial cable (1.5 meter/3 meter)

Ordering information:

The E5263A is a fixed-configuration product; there are no options or required accessories.



E5270B

Source Measure Units

E5270B 8-Slot Precision Measurement Mainframe

Perform precision DC parametric measurements
 Eight slots for plug-in modules
 Code compatible with 4142B

Solves the most extreme parametric measurement challenges

For engineers and scientists working on current and future semiconductor process technologies, the E5270B provides a solution that both meets their needs and lowers their cost of test. The wide variety of available modules and advanced measurement features provide a complete solution for parametric measurement and analysis. Both a *VXIplug&play* driver and TIS commands are provided as programming aids for customers who choose to use their own software instead of software provided by Agilent.

Unlike solutions that include both the system controller and measurement resources combined, the E5270B gives you the freedom to manage these resources separately, thereby avoiding the expensive problem of the system controller becoming obsolete years before other elements. The E5270B can be controlled from MS Windows-based, UNIX-based, or even LINUX-based operating system environments. Because you can upgrade your system controller hardware or software without losing the use of your instrument, your investment is protected against unforeseeable technology shifts.

Mainframe Characteristics

E5270B 8-Slot Precision Measurement Mainframe

Available slots	8
Ground Unit (GNDU) Sink Capability	4.0 A
Instrument control	GPIB
External trigger inputs/outputs	1 BNC trigger in; 1 BNC trigger out; 8 programmable trigger in/out

Module Selection Guide

	E5280B HPSMU	E5281B MPSMU	E5287A HRSMU	E5288A ASU
Required Slots	2	1	1	N/A
Maximum force voltage	±200 V	±100 V	±100 V	±100 V
Maximum force current	±1 A	±100 mA	±100 mA	±100 mA
Voltage measurement resolution	2 µV	0.5 µV	0.5 µV	0.5 µV
Current measurement resolution	10 fA	10 fA	1 fA	0.1 fA

Key features and benefits:

- **Ultra low current measurement without cumbersome external preamplifiers**
- **The E5270B HRSMU supplies 1-femtoamp measurement resolution** without the need for cumbersome external preamplifiers, providing an extremely efficient solution for situations not requiring ultra low current measurement. This innate capability enables you to meet the measurement challenges posed by the vast majority of current and future devices. The HRSMU

(and redesigned MPSMU) also provides voltage measurement resolution down to 0.5 microvolts. The HRSMU (as well as the redesigned MPSMU) also supports new 0.5 V and 5 V measurement ranges, which improve measurement accuracy for modern lower-voltage transistors. Advanced measurement features include multi-channel sweep mode with parallel test capability, linear/binary search, range management, and force value self-monitoring.

More detailed specifications at www.agilent.com/find/E5270B

Source Measure Units

E5270B 8-Slot Precision Measurement Mainframe (Continued)

- **Flexibility to provide stable 100 attoamp measurements**
- **The HRSMU accepts an optional atto sense and switch unit (ASU),** which increases the low current measurement resolution to 100 attoamps. This is invaluable for certain extreme characterization needs such as memory cell leakage testing. In addition, the ASU allows you to make voltage measurements and force both voltage and current up to the limits of the HRSMU specification.
- **Switch between CV and IV measurement without wasting time swapping cables**
- **The ASU enables switching between 100 attoamp measurement and precise capacitance measurement without changing any cabling.**
The ASU includes two BNC inputs that are compatible with the outputs of a capacitance meter. Simple software commands enable you to switch between SMU based measurement (IV) and capacitance meter based measurement (CV) without having to change any cabling. You can also use the BNC inputs with other instruments such as a digital voltmeter (DVM) or a pulse generator unit (PGU). No matter what your configuration, the ASU provides better switching measurement performance than an external switching matrix, and offers improved ease of use.
- **Cost-effective alternative that takes advantage of your own testing software**
- **Agilent provides an industry-standard VXIplug&play driver,** a high-level programming interface that saves time by allowing your programmers to avoid having to learn the detailed programming of the instrument. In addition, the TIS – test instruction set – interface enables code developed for the lab environment to be used in production. Specifically, TIS allows you to write algorithms for subsequent transfer to the Agilent 4070 production test environment.
- **No embedded controller in the instrument:** Manage your instrument measurement resources separately from your controller and software resources, ensuring that your test investment does not become obsolete too quickly.
- **HRSMU has 1 femtoamp current measurement resolution:** Can meet the measurement challenges posed by the vast majority of current and future devices, without the need for external preamplifiers.
- **HRSMU combines with optional atto sense and switch unit (ASU) to achieve 100 attoamp current measurement resolution:** Stable 100 attoamp current resolution via remote sensing meets the most demanding ultra low current measurement requirements.
- **Switch between CV and IV measurements on positioners via software commands:** No need to physically change cabling or move to a different probe station when changing from CV to IV measurement.
- **MPSMU and HRSMU can measure voltage with 0.5 microvolt resolution. Both SMUs also support new 0.5 V and 5 V measurement ranges:** Enables you to perform very demanding component matching and metal line resistance voltage measurements with ease.
- **Includes industry-standard VXIplug&play driver:** Ideal when you choose to use your own software, instead of Agilent-provided software. Improves programmer productivity by removing the need to learn detailed programming of the instrument.
- **TIS (Test Instruction Set) commands supported for both BASIC and C:** Develop algorithms on an instrument that you can then easily transport into your 4070 Series-based production test environment.

Accessories and cables:

- N1254A-100** Ground unit to Kelvin adapter
- 16442B** Test fixture
- 16494A-001/002** Triaxial cable (1.5 meter/3 meter)

Ordering information:

The E5270B does not have any base configuration. All desired modules, accessories, and cables must be specified at the time of order.

Note: Since the E5270B is a modular product, you can add new modules to it at any time after initial purchase as long as you have open slots.



B1500A

Device Analyzer/ Curve Tracers

B1500A Semiconductor Device Analyzer

PC-based instrument with Windows® XP Professional OS
 Single-box solution for current-voltage (IV), capacitance-voltage (CV), pulse generation, fast IV, and time-domain measurement
 Ten module slots for source monitor units (SMUs) and other module types (MFCMU, HV-SPGU and WGF MU)
 Offline data analysis and application test development via Desktop EasyEXPERT software

Mainframe Characteristics

B1500A Semiconductor Device Analyzer

Available slots	10
Ground unit (GNDU) sink capability	4.2 A
USB ports	2 front and 2 rear
Instrument control	GPIB
Networking	100BASE-TX/10BASE-T LAN Port
External trigger inputs/outputs	1 BNC trigger in; 1 BNC trigger out; 8 programmable trigger in/out

The Agilent B1500A semiconductor device analyzer is a modular instrument with a ten-slot configuration that supports both IV and CV measurements and also fast high-voltage pulsing. Its familiar, Microsoft® Windows® user interface supports Agilent's EasyEXPERT software, which provides a new, more intuitive task-oriented approach to device characterization. Because of its extremely low-current, low-voltage, and integrated capacitance measurement capabilities, the Agilent B1500A can be used for a wide range of semiconductor device characterization needs (IC-CAP supports the B1500A). It is also an excellent solution for non-volatile memory cell characterization and high-speed device characterization (including advanced NBTI measurement).

Key features and benefits:

- Superior IV measurement performance: 0.1 fA/0.5 μV measurement resolution
- Optional, integrated capacitance module supports CV measurements up to 5 MHz
- Over 230 predefined application tests to get you up and running quickly
- EasyEXPERT software provides an innovative, task-based approach to parametric test

Module Selection Guide

Required slot Main specification

Module	Required slot	Main specification
B1510A HPSMU	2	Up to 200 V, 1 A force. 10 fA current resolution
B1511A MPSMU	1	Up to 100 V, 100 mA force, 10 fA current resolution
B1517A HRSMU	1	Up to 100 V, 100 mA force, 1 fA current resolution
E5288A ASU	NA	Up to 100 V, 100 mA force, 100 Aa current resolution
B1520A MFCMU	1	1 kHz to 5 MHz, up to 100 V DC bias with SMU
B1525A HV-SPGU	1	Min 12.5 ns pulse width, 10 ns transition time, up to 40 V with 3 level pulse
B1530A WGF MU	1	Min 100 ns pulse width, 10 V peak-to-peak output, 5 ns current or voltage measurement sampling speed

More detailed specifications at www.agilent.com/find/B1500A

Device Analyzer/Curve Tracers

B1500A Semiconductor Device Analyzer (Continued)

Key features and benefits (Continued):

- Optional positioner-based CV-IV switching solutions available with 0.5 μ V voltage measurement resolution and 10 fA, 1 fA or 0.1 fA current measurement resolution capability
- Easy test automation with built-in semiautomatic wafer prober drivers and test sequencing without programming via the Quick Test mode
- Optional high-voltage semiconductor pulse generator unit (HV-SPGU) available with 10 ns programmable pulse widths and ± 40 V (80 V peak-to-peak) output
- Optional waveform generator/fast measurement unit (WGFMU) available with ALWG and fast current or voltage measurement capabilities
- 10 ns pulsed IV solution is available for characterizing high-k gate dielectric and SOI (silicon-on-insulator) transistors
- A Classic Test mode is available to provide the look, feel, and terminology of the 4155/4156 interface while enhancing user interaction by taking full advantage of Microsoft Windows GUI features

Key B1500A accessories:

- N1254A-100** Ground unit to Kelvin adapter
- N1300-001** Capacitance measurement unit cable (1.5 m)
- N1300-002** Capacitance measurement unit cable (3 m)
- N1301A-100** SMU CMU unify unit (SCUU)
- N1301A-102** SCUU cable (3 m)
- N1301A-110** SCUU magnetic stand
- N1301A-200** Guard switch unit (GSWU)
- N1301A-201** Guard switch unit cable (1 m)
- N1301A-202** Guard switch unit cable (3 m)

Ordering information:

- B1500A-015** 1.5 m cable (cable length is set to 1.5 m for standard and add-on packages)
- B1500A-030** 3.0 m cable (cable length is set to 3.0 m for standard and add-on packages)
- B1500A-A6J** ANSI Z540 compliant calibration
- B1500A-UK6** commercial calibration certificate with test data
- B1500A-ABA** English paper document
- B1500A-ABJ** Japanese paper document
- B1500A-A00** empty package for custom solution
- B1500A-A01** standard package (MPSMU 4 ea. & cables)
- B1500A-A02** high resolution package (HRSMU 4 ea. & cables)
- B1500A-A03** high power package (HPSMU 2 ea, MPSMU 2 ea & cables)
- B1500A-A04** basic flash memory cell package (MPSMU 4 ea, SPGU, accessories)
- B1500A-A10** HPSMU add-on (HPSMU 1 ea. & cables)
- B1500A-A11** MPSMU add-on (MPSMU 1 ea. & cables)
- B1500A-A17** HRSMU add-on (HRSMU 1 ea. & cables)
- B1500A-A20** MFCMU add-on (MFCMU, cable)
- B1500A-A25** HVSPGU add-on (HVSPGU 1 ea. & cables)
- B1500A-A28** ASU (atto sense unit) add-on (ASU 1 ea. & cables)
- B1500A-A30** WGFMU add-on (WGFMU 1 ea. RSU 2 ea. & cables)
- B1500A-A31** WGFMU add-on with connector adapter (WGFMU 1 ea, RSU 2 ea, cables & connector adapter)
- B1500A-A3P** WGFMU probe cable kit (8 probe cables. WGFMU is not included)
- B1500A-A5F** test fixture for packaged device measurement (16442B 1 ea)

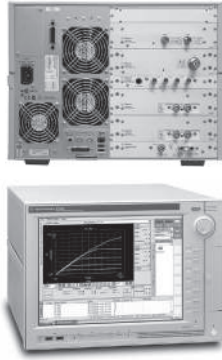

B1505A

Device Analyzer/ Curve Tracers

B1505A Power Device Analyzer/ Curve Tracer

PC-based instrument with Windows® XP Professional OS
 Single-box solution for current-voltage (IV) from sub-pA up to 3000 V and 40 A, and capacitance-voltage (CV) at up to 3000 V of DC bias.
 Ten module slots for SMUs (HPSMU, HCSMU, HVSMU) and Multi Frequency Capacitance Measurement Unit (MFCMU)
 Offline data analysis and application test development via Desktop EasyEXPERT software

Mainframe Characteristics

B1505A Power Device Analyzer/ Curve Tracer

Available slots	10
Ground unit (GNDU) sink capability	4.2 A
USB ports	2 front and 2 rear
Instrument control	GPIO
Networking	100BASE-TX/10BASE-T LAN Port
External trigger inputs/outputs	1 BNC trigger in; 1 BNC trigger out; 8 programmable trigger in/out

The Agilent B1505A Power Device Analyzer / Curve Tracer is the only single box solution available today with the capability to characterize high power devices from the sub-picoamp level at up to 3000 volts and 40 amps. This capability covers evaluation for new power device using wide band gap materials such as SiC GaN. The B1505A software environment allows users to check device characteristics and detect device faults with the easy convenience of a curve tracer. Just like on a curve tracer, the B1505A supports rotary knob control of the independent sweep variable for intuitive and real-time evaluation of parameters such as breakdown voltage. The B1505A's test fixture can accept a wide variety of devices, such as power MOSFETs, diodes and IGBTs, regardless of their size or shape via a large fixture adapter with customizable fixture modules. In addition, the test fixture's built-in interlock mechanism ensures that high voltages and currents can be applied to test devices safely.

Module Selection Guide

Required slot

Main specification

B1510A HPSMU	2	Up to ±200 V, ±1 A force, 10 fA current resolution
B1512A HCSMU	2	Up to ±40 V, ±1 A force, 10 pA current resolution
B1513A HVSMU	2	Up to ±3000 V, ±4 mA force, 10 fA current resolution
B1520A MFCMU	1	1 kHz to 5 MHz, up to 3000 V DC bias with HVSMU

Device Analyzer/Curve Tracers

B1505A Power Device Analyzer/Curve Tracer (Continued)

Key features and benefits:

- One box solution for accurate and easy power device evaluation and analysis
- Accurate power device characterization across the entire operating range
- Unique high-voltage (3000 V) capacitance measurement capability
- Flexible and expandable architecture protects your investment
- Accurately characterize SiC, GaN and diamond devices at up to 3000 V
- Support modeling software reduces development times
- Up to 40 A current capabilities facilitate advanced device characterization
- True curve tracer knob sweep functionality combined with PC data management
- New features improve curve tracer functionality and boosts productivity
- EasyEXPERT software provides a task-oriented approach to power device testing
- Powerful auto-analysis functions
- Safe and supported packaged device testing at 3000 V and 40 A
- On-wafer measurement and automation capabilities reduce cycle times

Key B1505A accessories:

- N1258A** Module selector
- N1259A** Test fixture
- N1260A** High voltage bias-T
- N1261A** Protection adapter
- N1262A** Resistor box

Ordering information:

The B1505A does not have any automatic “base” configuration. All desired modules, accessories, and cables must be distinctly specified at the time of order.

Note: Since the B1505A is a modular product, you can add new modules to it at any time after initial purchase if the configuration is allowed.

DC Electronic Loads...

maximize throughput with
real life loading conditions

Agilent DC electronic loads provide solutions for the problems of testing DC power sources.

Multiple Input Electronic Loads

The Agilent N3300A series of DC electronic loads has been optimized for the needs of high volume manufacturing test. Test throughput is maximized with both faster speed and specialized programming and measurement capabilities. The accuracy is enhanced over previous Agilent electronic loads, to meet the needs of testing today's smaller power supplies.

Single Input Electronic Loads

The 6060B and 6063B are single input DC electronic loads. They are convenient for testing of one single output DC power supply. They provide a total solution, with built-in measurement functions. However, to maximize either speed or accuracy, the N3300A series electronic loads are recommended.

Multiple-Input 150 W to 600 W



N3300A-N3307A



Standard DC connectors

Option UJ1 8 mm screw connectors

- Decrease system development time
- Increase system reliability
- Increase system flexibility
- DC connection terminal for ATE applications
- Lower cost of ownership
- Increase test system throughput
- Stable operation down to zero volts

Increase Test Throughput

Today's high volume manufacturing requires optimization of test system throughput, to maximize production volume without increasing floor-space. The N3300A series electronic loads can help you in a number of ways to achieve this goal.

Reduced command processing time

Commands are processed more than 10 times faster than previous electronic loads.

Automatically execute stored command sequences

"Lists" of downloaded command sequences can execute independent of the computer, greatly reducing the electronic load command processing time and computer interaction time during product testing.

Programmable delay allows for either simultaneous or sequential load changes

This is the most efficient way to conduct testing of multiple output DC power supplies, simulating real-life loading patterns, with a minimum of programming commands.

Buffer measurement data

Voltage, current, and power measurements can be buffered for later readback to the computer, reducing computer interaction.

Control measurement speed vs. accuracy

Decrease the number of measurement samples to achieve greater measurement speed, or increase the number of samples to achieve higher measurement accuracy. You can optimize your measurements for each test.

Control rising and falling slew rates separately

Reduce rate of loading change when necessary for DUT stability or to simulate real life conditions, but otherwise change load values at maximum rate.

Increase System Flexibility... for Both Present and Future Requirements

Most power supply and battery charger test systems designed today need to test a variety of products and/or assemblies. In the future, additional products or assemblies may be needed. A flexible family of electronic loads makes present system design and future growth much easier.

Test low voltage power supplies

The N3300A series electronic loads operate with full stability down to zero volts. Many other electronic loads available today have been found to become unstable in the

operating region below one volt. When designing power supply test platforms, the trend towards lower voltage requirements should be taken into account. Refer to the specification and supplemental characteristic tables for details of lower voltage operating characteristics.

Choose DC load connection method

Automatic test systems need consistency and reliability. Option UJ1 8 mm screw connectors provide a simple screw onto which your wires, terminated with insulated ring terminals, may be securely mounted. This optional connector is specifically designed for test systems. Wires may exit the plastic cover in any direction, and multiple wires may be placed on each screw terminal for easy parallel load connections. Up to AWG 4 wire may be used.

Applications which require repeated connections/disconnections are better suited to the standard connector. The standard connector accepts an unterminated wire, and may be hand-tightened. This connector is specifically designed for bench applications and short-term automated tests.

Multiple-Input: 150 W to 600 W (Continued)

Design a system to test a variety of products

This series consists of 2 mainframes and 5 modules. The N3300A mainframe is full rack width. It has 6 slots. The N3301A mainframe is half rack width. It has 2 slots. Any assortment of the 5 different modules can be configured into these mainframes, up to the slot capacity. The N3302A (150 watts), N3303A (250 watts), N3307A (250 watts) and N3304A (300 watts) each require one slot. The N3305A (500 watts) and the N3306A (600 watts) each require 2 slots. The electronic load can be configured to supply exactly what you need now, and this modular design also allows for easy future reconfiguration.

Test high current power supplies

Electronic load modules can be operated in parallel to provide additional current sinking capability.

Control the electronic load how you want to

GPIO, RS232, and manual use of the front panel all provide complete control of these electronic loads. There are also analog programming and monitoring ports for those applications that utilize non-standard interfaces, require custom waveforms, or utilize process control signals. Custom waveforms can also be created by downloading a "List" of load parameters. In addition, there is a built-in transient generator, which operates in all modes.

Quickly create powerful and consistent software

All Agilent Technologies electronic loads use the SCPI (Standard Commands for Programmable Instruments) command set. This makes learning the commands easy, because they are the same format as all other SCPI instruments. The resulting code is virtually self-documenting, and therefore easier to troubleshoot and modify in the future. *Plug-n-Play* drivers are also available to help you to integrate the loads into your standard software packages.

Make Measurements Easily and Accurately

The 16-bit voltage, current and power measurement system provides both accuracy and convenience. The alternative is using a dmm (digital multimeter) and MUX (multiplexer) along with a precision current shunt and a lot of extra wiring. Avoiding this complexity increases system reliability and makes the system easier to design and support. Current measurements in particular are more consistently accurate using the electronic load's internal system, because the wiring associated with an external precision current shunt may pick up noise.

Measure with all load modules simultaneously

Testing multiple-output DC power supplies and DC-DC converters can be very time consuming if each output must be tested sequentially. If measurements are being made through a MUX using one DMM,

this is what will happen. Using the built-in measurement capabilities of the N3300A electronic loads, all outputs can be measured simultaneously. Alternatively, multiple single output power sources can be tested simultaneously.

Measure voltage and current simultaneously

The N3300A measurement system has individual but linked current and voltage measurement systems. This means that voltage and current measurements are taken exactly simultaneously, which gives a true picture of the power supply under test's output at a particular moment in time. Some other electronic loads which feature internal measurement systems actually take current and voltage measurements sequentially, and therefore do not give as accurate a picture of momentary power.

Observe transient behavior using waveform digitization

Transient response and other dynamic tests often require an oscilloscope. The N3300A has a flexible waveform digitizer with a 4096 data point buffer for voltage and a 4096 data point buffer for current. Under many circumstances, this internal digitizer will be adequate for power supply test needs. Current and voltage are digitized simultaneously, and the sampling rate and sample window are programmable. Some analysis functions are provided, including RMS, max and min.

Multiple-Input: 150 W to 600 W (Continued)

Table A-1 Specifications

Table A-1 lists the specifications for the different load models. Specifications indicate warranted performance in the 25°C ±5°C region of the operating temperature range. Specifications apply to normal and transient modes unless otherwise noted.

Input characteristic

Operating contour

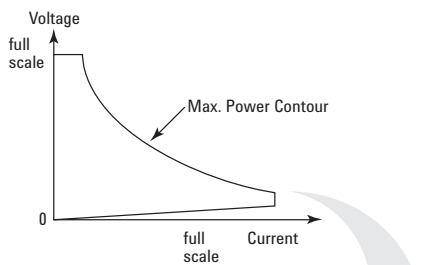

Derated current detail

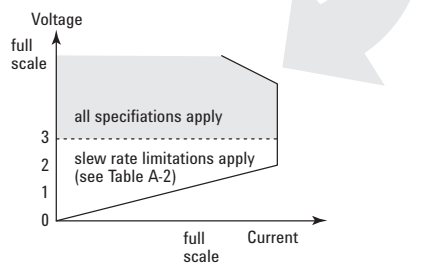

Notes

- Maximum continuous power available is derated linearly from 100% of maximum at 40°C, to 75% of maximum at 55°C.
- Specification is ± (% of reading + fixed offset). Measurement is 1000 samples. Specification may degrade when the unit is subject to an RF field of 3 V/meter, the unit is subject to line spikes of 500 V, or an 8 kV electrostatic discharge.
- DC current accuracy specifications apply 30 seconds after input current is applied.

	N3302A	N3303A	N3304A	N3305A	N3306A	N3307A
Input ratings						
Current	0 - 30 A	0 - 10 A	0 - 60 A	0 - 60 A	0 - 120 A	0 - 30 A
Voltage	0 - 60 V	0 - 240 V	0 - 60 V	0 - 150 V	0 - 60 V	0 - 150 V
Maximum power @ 40°C ¹	150 W	250 W	300 W	500 W	600 W	250 W
Specified current @ low voltage operation						
2.0 V	30 A	10 A	60 A	60 A	120 A	30 A
1.5 V	22.5 A	7.5 A	45 A	45 A	90 A	22.5 A
1.0 V	15 A	5 A	30 A	30 A	60 A	15 A
0.5 V	7.5 A	2.5 A	15 A	15 A	30 A	7.5 A
0 V	0 A	0 A	0 A	0 A	0 A	0 A
Typical minimum operating voltage @ full scale current	Table A-1 states that maximum current is available down to 2 volts. Typically, however under normal operating conditions, the load can sink the maximum current down to the following voltages:					
	1.2 V	1.2 V	1.2 V	1.4 V	1.4 V	1.4 V
Constant current mode²						
Low range/high range	3 A/30 A	1 A/10 A	6 A/60 A	6 A/60 A	12 A/120 A	3 A/30 A
Regulation	10 mA	8 mA	10 mA	10 mA	10 mA	10 mA
Low range accuracy 0.1% +	5 mA	4 mA	7.5 mA	7.5 mA	15 mA	7.5 mA
High range accuracy 0.1% +	10 mA	7.5 mA	15 mA	15 mA	37.5 mA	15 mA
Constant voltage mode²						
Low range/high range	6 V/60 V	24 V/240 V	6 V/60 V	15 V/150 V	6 V/60 V	15 V/150 V
Regulation	5 mV	10 mV	10 mV	10 mV	20 mV	10 mV
Low range accuracy 0.1% +	3 mV	10 mV	3 mV	10 mV	3 mV	10 mV
High range accuracy 0.1% +	8 mV	40 mV	8 mV	20 mV	8 mV	20 mV
Constant resistance mode²						
Range 1 (I >10% of current rating)	0.067-4 Ω	0.2-48 Ω	0.033-2 Ω	0.033-5 Ω	0.017-1 Ω	0.067-10 Ω
Range 2 (I >1% of current rating)	3.6-40 Ω	44-480 Ω	1.8-20 Ω	4.5-50 Ω	0.9-10 Ω	9-100 Ω
Range 3 (I >0.1% of current rating)	36-400 Ω	440-4800 Ω	18-200 Ω	45-500 Ω	9-100 Ω	90-1000 Ω
Range 4 (I >0.01% of current rating)	360-2000 Ω	4400-12000 Ω	180-2000 Ω	450-2500 Ω	90-1000 Ω	900-2500 Ω
Transient generator						
Frequency range	0.25 Hz-10 kHz	0.25 Hz-10 kHz	0.25 Hz-10 kHz	0.25 Hz-10 kHz	0.25 Hz-10 kHz	0.25 Hz-10 kHz
Pulse width	50 μs ±1% to 4 seconds ±1%	50 μs ±1% to 4 seconds ±1%	50 μs ±1% to 4 seconds ±1%	50 μs ±1% to 4 seconds ±1%	50 μs ±1% to 4 seconds ±1%	50 μs ±1% to 4 seconds ±1%
Current measurement²						
Low range/high range	3 A/30 A	1 A/10 A	6 A/60 A	6 A/60 A	12 A/120 A	3 A/30 A
Low range accuracy ³ 0.05% +	3 mA	2.5 mA	5 mA	5 mA	10 mA	3 mA
High range accuracy ³ 0.05% +	6 mA	5 mA	10 mA	10 mA	20 mA	6 mA
Voltage measurement²						
Low range/high range	6 V/60 V	24 V/240 V	6 V/60 V	15 V/150 V	6 V/60 V	15 V/150 V
Low range accuracy 0.05% +	3 mV	10 mV	3 mV	8 mV	3 mV	8 mV
High range accuracy 0.05% +	8 mV	20 mV	8 mV	16 mV	8 mV	16 mV
Power measurement²						
Accuracy 0.1% +	0.5 W	1.2 W	0.5 W	1.5 W	1.2 W	0.5 W

Multiple-Input: 150 W to 600 W (Continued)

Table A-2
Supplemental Characteristics

Table A-2 lists the supplemental characteristics, which are not warranted but are descriptions of typical performance determined either by design or type testing.

Notes

¹ Slew rate bands are the ranges of programmable slew rates available. When you program a slew rate value outside the indicated bands, the electronic load will automatically adjust the slew rate to fit within the band that is closest to the programmed value. It is not necessary to specify the band, only the slew rate itself.

Below 3 volts, the maximum bandwidth of the electronic load is reduced by a factor of ten to one. For example, in the current range for Model N3302A, the maximum slew rate is specified as 2.5 MA/s, below 3 volts the maximum slew rate would be 250 kA/s. Any slew rate programmed between 2.5 MA/s and 250 kA/s would produce a slew rate of 250 k/s. Slew rates programmed slower than 250 kA/s would still correctly reflect their programmed value. Note that if you are using transient mode to generate a high frequency pulse train, a reduced slew rate might cause the load to never reach the upper programmed value before beginning the transition to the lower programmed value. So even though the transient mode is still operational at lower voltages, a fast pulse train with large transitions may not be achievable.

		N3302A	N3303A	N3304A	N3305A	N3306A	N3307A
Programming resolution							
Constant current mode		0.05 mA/ 0.5 mA	0.02 mA/ 0.2 mA	0.1 mA/ 1 mA	0.1 mA/ 1 mA	0.2 mA/ 2 mA	0.05 mA/ 0.5 mA
Constant voltage mode		0.1 mV/1 mV	0.4 mV/4 mV	0.1 mV/1 mV	0.25 mV/2.5 mV	0.1 mV/1 mV	0.25 mV/2.5 mV
Constant resistance mode		0.07/0.7/ 7/70 mΩ	0.82/8.2/ 82 mΩ	0.035/0.35/ 3.5/35 mΩ	0.085/0.85/ 8.5/85 mΩ	0.0175/0.175/ 1.75/17.5 mΩ	0.17/1.7/ 17/170 mΩ
Readback resolution							
Current		0.05 mA/ 0.5 mA	0.02 mA/ 0.2 mA	0.1 mA/ 1 mA	0.1 mA/ 1 mA	0.2 mA/ 2 mA	0.05 mA/ 0.5 mA
Voltage		0.1 mV/ 1 mV	0.4 mV/ 4 mV	0.1 mV/ 1 mV	0.25 mV/ 2.5 mV	0.1 mV/ 1 mV	0.25 mV/ 2.5 mV
Programmable slew rate¹							
Current ranges	Slow band	500 A/s - 25 kA/s	167 A/s - 8330 A/s	1 kA/s - 50 kA/s	1 kA/s - 50 kA/s	2 kA/s - 100 kA/s	500 A/s - 25 kA/s
	Fast band ≥3 V	50 kA/s - 2.5 MA/s	16.7 kA/s - 833 kA/s	100 kA/s - 5 MA/s	100 kA/s - 5 MA/s	200 kA/s - 10 MA/s	50 kA/s - 2.5 MA/s
	Fast band <3 V	50 kA/s - 250 kA/s	16.7 kA/s - 83.3 kA/s	100 kA/s - 500 kA/s	100 kA/s - 500 kA/s	200 kA/s - 1 MA/s	50 kA/s - 250 kA/s
Voltage ranges	Slow band	1 kV/s - 50 kV/s	4 kV/s - 200 kV/s	1 kV/s - 50 kV/s	2.5 kV/s - 125 kV/s	1 kV/s - 50 kV/s	2.5 kV/s - 125 kV/s
	Fast band ≥3 V	100 kV/s - 500 kV/s	400 kV/s - 2 MV/s	100 kV/s - 500 kV/s	250 kV/s - 1.25 MV/s	100 kV/s - 500 kV/s	250 kV/s - 1.25 MV/s
	Fast band <3 V	100 kV/s - 50 kV/s	400 kV/s - 200 kV/s	100 kV/s - 50 kV/s	250 kV/s - 125 kV/s	100 kV/s - 50 kV/s	250 kV/s - 125 kV/s
Resistance range 1	Slow band	44 Ω/s - 1125 Ω/s	540 Ω/s - 13.5 kΩ/s	22 Ω/s - 560 Ω/s	55 Ω/s - 1400 Ω/s	11 Ω/s - 280 Ω/s	110 Ω/s - 2800 Ω/s
	Fast band ≥3 V	2250 Ω/s - 34 kΩ/s	27 kΩ/s - 408 kΩ/s	1120 Ω/s - 17 kΩ/s	2800 Ω/s - 42.5 kΩ/s	560 Ω/s - 8.5 kΩ/s	5600 Ω/s - 85 kΩ/s
	Fast band <3 V	2250 Ω/s - 3.4 kΩ/s	27 kΩ/s - 40.8 kΩ/s	1120 Ω/s - 1.7 kΩ/s	2800 Ω/s - 4.25 kΩ/s	560 Ω/s - 850 Ω/s	5600 Ω/s - 8.5 kΩ/s
Resistance range 2	Slow band	440 Ω/s - 11.25 kΩ/s	5.4 kΩ/s - 135 kΩ/s	220 Ω/s - 5600 Ω/s	550 Ω/s - 14 kΩ/s	110 Ω/s - 2800 Ω/s	1.1 kΩ/s - 28 kΩ/s
	Fast band ≥3 V	22.5 kΩ/s - 340 kΩ/s	270 kΩ/s - 4.08 MΩ/s	11.2 kΩ/s - 170 kΩ/s	28 kΩ/s - 425 kΩ/s	5600 Ω/s - 85 kΩ/s	56 kΩ/s - 850 kΩ/s
	Fast band <3 V	22.5 kΩ/s - 34 kΩ/s	270 kΩ/s - 408 kΩ/s	11.2 kΩ/s - 17 kΩ/s	28 kΩ/s - 42.5 kΩ/s	5600 Ω/s - 8.5 kΩ/s	56 kΩ/s - 85 kΩ/s
Resistance range 3	Slow band	4.4 kΩ/s - 112.5 kΩ/s	54 kΩ/s - 1.35 MΩ/s	2.2 kΩ/s - 56 kΩ/s	5.5 kΩ/s - 140 kΩ/s	1.1 kΩ/s - 28 kΩ/s	11 kΩ/s - 280 kΩ/s
	Fast band ≥3 V	225 kΩ/s - 3.4 MΩ/s	2.7 MΩ/s - 40.8 MΩ/s	112 kΩ/s - 1.7 MΩ/s	280 kΩ/s - 4.25 MΩ/s	56 kΩ/s - 850 kΩ/s	560 kΩ/s - 8.5 MΩ/s
	Fast band <3 V	225 kΩ/s - 340 kΩ/s	2.7 MΩ/s - 4.08 MΩ/s	112 kΩ/s - 170 kΩ/s	280 kΩ/s - 425 kΩ/s	56 kΩ/s - 85 kΩ/s	560 kΩ/s - 850 kΩ/s
Resistance range 4	Slow band	44 kΩ/s - 1.125 MΩ/s	540 kΩ/s - 13.5 MΩ/s	22 kΩ/s - 560 kΩ/s	55 kΩ/s - 1.4 MΩ/s	11 kΩ/s - 280 kΩ/s	110 kΩ/s - 2.8 MΩ/s
	Fast band ≥3 V	2.25 MΩ/s - 34 MΩ/s	27 MΩ/s - 408 MΩ/s	1.12 MΩ/s - 17 MΩ/s	2.8 MΩ/s - 42.5 MΩ/s	560 kΩ/s - 8.5 MΩ/s	5.6 MΩ/s - 85 MΩ/s
	Fast band <3 V	2.25 MΩ/s - 3.4 MΩ/s	27 MΩ/s - 40.8 MΩ/s	1.12 MΩ/s - 1.7 MΩ/s	2.8 MΩ/s - 4.25 MΩ/s	560 kΩ/s - 850 kΩ/s	5.6 MΩ/s - 8.5 MΩ/s

Multiple-Input: 150 W to 600 W (Continued)

**Table A-2 (Continued)
Supplemental Characteristics**

Table A-2 lists the supplemental characteristics, which are not warranted but are descriptions of typical performance determined either by design or type testing.

Notes

² Applies to all ranges.

	N3302A	N3303A	N3304A	N3305A	N3306A	N3307A
Programmable short	66 mΩ max.	200 mΩ max.	33 mΩ max.	33 mΩ max.	17 mΩ max.	33 mΩ max.
	40 mΩ typical	100 mΩ typical	20 mΩ typical	25 mΩ typical	12 mΩ typical	20 mΩ typical
Programmable open	≥20 kΩ	≥80 kΩ	≥20 kΩ	≥20 kΩ	≥20 kΩ	≥80 kΩ
Command processing time						
Using discrete commands	3 ms	3 ms	3 ms	3 ms	3 ms	3 ms
Using list commands	1 ms	1 ms	1 ms	1 ms	1 ms	1 ms
List dwell characteristics						
Range	0 - 10 s	0 - 10 s	0 - 10 s	0 - 10 s	0 - 10 s	0 - 10 s
Resolution	1 ms	1 ms	1 ms	1 ms	1 ms	1 ms
Accuracy	5 ms	5 ms	5 ms	5 ms	5 ms	5 ms
Measurement time						
1000 samples (default)	20 ms (with specified measurement accuracy)	20 ms (with specified measurement accuracy)	20 ms (with specified measurement accuracy)	20 ms (with specified measurement accuracy)	20 ms (with specified measurement accuracy)	20 ms (with specified measurement accuracy)
200 samples	10 ms (with <6% additional fixed offset)	10 ms (with <6% additional fixed offset)	10 ms (with <6% additional fixed offset)	10 ms (with <6% additional fixed offset)	10 ms (with <6% additional fixed offset)	10 ms (with <6% additional fixed offset)
100 samples	9 ms (with <10% additional fixed offset)	9 ms (with <10% additional fixed offset)	9 ms (with <10% additional fixed offset)	9 ms (with <10% additional fixed offset)	9 ms (with <10% additional fixed offset)	9 ms (with <10% additional fixed offset)
20 points	7 ms (with <30% additional fixed offset)	7 ms (with <30% additional fixed offset)	7 ms (with <30% additional fixed offset)	7 ms (with <30% additional fixed offset)	7 ms (with <30% additional fixed offset)	7 ms (with <30% additional fixed offset)
<20 points	7 ms (with >30% additional fixed offset)	7 ms (with >30% additional fixed offset)	7 ms (with >30% additional fixed offset)	7 ms (with >30% additional fixed offset)	7 ms (with >30% additional fixed offset)	7 ms (with >30% additional fixed offset)
Ripple and noise (20 Hz - 10 MHz)						
Current (rms/peak to peak)	2 mA/20 mA	1 mA/10 mA	4 mA/40 mA	4 mA/40 mA	6 mA/60 mA	2 mA/20 mA
Voltage (rms)	5 mV _{rms}	12 mV _{rms}	6 mV _{rms}	10 mV _{rms}	8 mV _{rms}	10 mV _{rms}
External analog programming						
Voltage programming accuracy ²	0.5% + 12 mV	0.5% + 48 mV	0.5% + 12 mV	0.5% + 30 mV	0.5% + 12 mV	0.5% + 30 mV
Current programming accuracy ²	0.25% + 4.5 mA	0.25% + 1.5 mA	0.25% + 9 mA	0.25% + 9 mA	0.25% + 18 mA	0.25% + 4.5 mA
External monitor ports						
Voltage monitor accuracy	0.25% + 12 mV	0.25% + 48 mV	0.25% + 12 mV	0.25% + 30 mV	0.25% + 12 mV	0.25% + 30 mV
Current monitor accuracy	0.1% + 4.5 mA	0.1% + 1.5 mA	0.1% + 9 mA	0.1% + 9 mA	0.1% + 18 mA	0.1% + 4.5 mA

Multiple-Input: 150 W to 600 W (Continued)

**Table A-3
Supplemental Characteristics**

	N3300A	N3301A
Operating temperature range	0°C to 55°C	0°C to 55°C
Input ratings		
Operating range	100 - 250 VAC 48 - 63 Hz	100 - 250 VAC 48 - 63 Hz
Input current	4.2 A @ 100 - 127 VAC 2.2 A @ 200 - 250 VAC	2.3 A @ 100 - 250 VAC
Input VA	440 VA	230 VA
Inrush current	38 A	18 A @ 115 VAC 36 A @ 230 VAC

Application notes

Agilent AN 372-1 Power Supply Testing
(AN 372-1)
5952-4190

Agilent AN 372-2 Battery Testing
(AN 372-2)
5952-4191

Increasing DC Power Supply Test System Throughput with Agilent Technologies N3300A DC Electronic Loads
5980-0233E

Agilent Zero Volt Electronic Load
5968-6360E

Making Fuel Cell AC Impedance Measurements Utilizing Agilent N3300A Series Electronic Loads
5988-5358EN

Supplemental characteristics for all model numbers

Analog programming bandwidth:
10 kHz (-3 db frequency) in CC mode only

Analog programming voltage:
Voltage: 0 - 10 V
Current: 0 - 10 V

Analog monitor ports:
Voltage: 0 - 10 V
Current: 0 - 10 V

Remote sensing:
5 VDC between sense and load input

Digital/trigger inputs:
 $V_{il} = 0.9 \text{ V max at } I_{il} = -1 \text{ mA}$
 $V_{ih} = 3.15 \text{ V min}$
(pull-up resistor on input)

Digital/trigger outputs:
 $V_{ol} = 0.72 \text{ V max at } I_{ol} = 1 \text{ mA}$
 $V_{oh} = 4.4 \text{ V min at } I_{oh} = -20 \mu\text{A}$

Agilent Models: N3300A

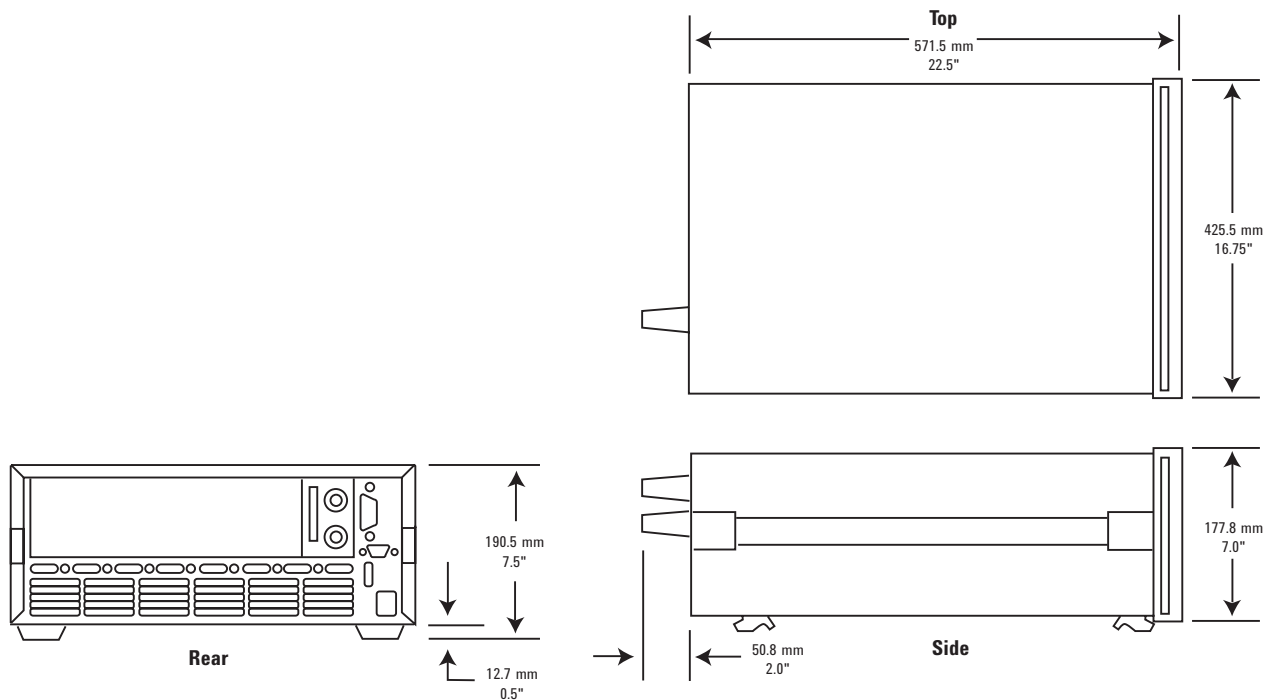

More detailed specifications at www.agilent.com/find/N3300

Multiple-Input: 150 W to 600 W (Continued)

Software driver:

VXIPlug&Play

Net weight:

N3300A: 13.2 kg (29 lb); N3301A: 7.3 kg (16 lb); N3302A, N3303A or N3304A: 2.7 kg (6 lb); N3305A or N3306A: 4.6 kg (10 lb), N3307A 2.7 kg (6 lb)

Shipping weight:

N3300A: 17 kg (38 lb); N3301A: 9.1 kg (20 lb) N3302A, N3303A, or N3304A: 4.1 kg (9 lb) N3305A or N3306A: 6.8 kg (15 lb), N3307A 4.1 kg (9 lb)

Warranty: Three years

Ordering information

Opt. UJG Standard finger twist connector

Opt. UJ1 8 mm screw terminal connector (available on all load modules N3302A-N3307A)

Opt 0L1 English printed users and programming guide (full documentation on CD-ROM)

Accessories

* **1CM001A** Rack mount flange kit including filler panel 177.0 mm H (4U) - one bracket, one half-module bracket (N3301A)

* **1CP012A** Rack mount flange and handle kit 88.1 mm H (2U) - four brackets (4U total); front handles (N3300A)

* **1CM020A** Rack mount flange kit 88.1 mm H (2U) - 4 brackets (4U total); 1.75 in hole spacing (N3300A)

* **1CM034A** Rack mount flange kit 177.0 mm H (4U) - two flange brackets (N3301A)

E3663AC Support rails for Agilent rack cabinets

*Support rails or slides required

Agilent Models: N3301A

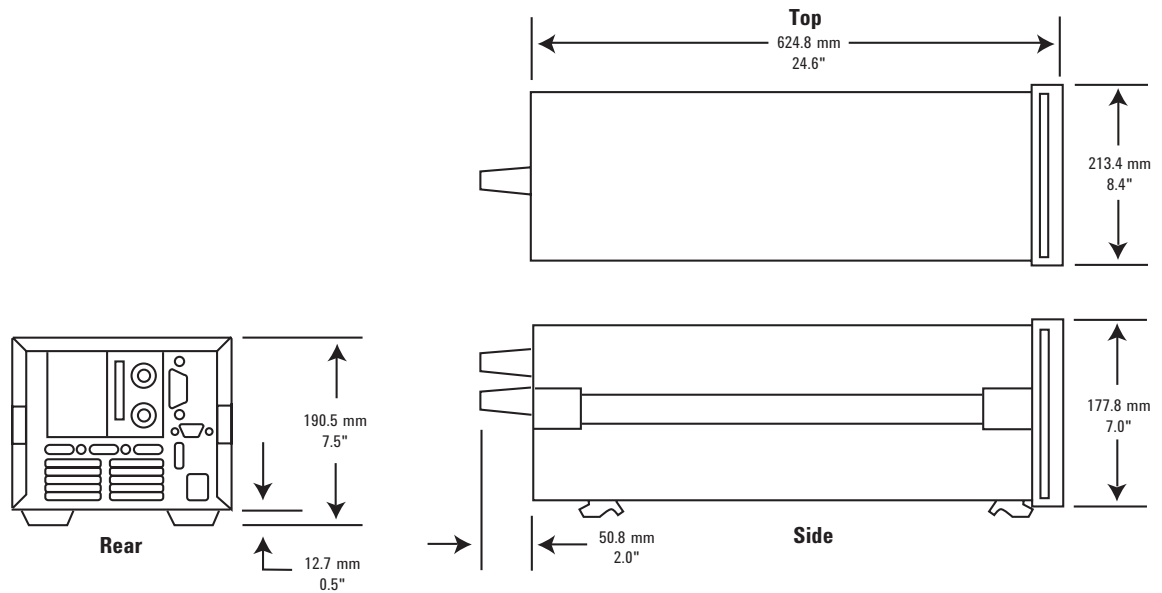

More detailed specifications at www.agilent.com/find/N3300

Single-Input 250 W to 300



6060B and 6063B

Cost-effective for single input applications
Convenient optional front panel input connection

The 6060B and 6063B each provides one load input. This is more convenient for single input applications than a mainframe product.

These electronic loads are particularly suited for the lab bench. Entering commands manually using the front panel keypad is simpler because the channel does not need to be specified, as in a mainframe configuration. The keypad entry is further simplified because these products do not have the downloadable LIST feature of the N3300A Series, which helps to maximize production throughput. Extensive protection is included to help protect your valuable prototypes under test. This includes overvoltage, overcurrent, overtemperature, overpower, and reverse polarity.

These loads are suitable for manufacturing test systems where maximizing speed is not critical. They use industry standard SCPI instructions, and also have *VXIPlug&Play* drivers to simplify system design. For the greatest speed and accuracy in programming and measurement, see the N3300A series of DC electronic loads.

Specifications	6060B	6063B
Amperes	0 to 60 A	0 to 10 A
Volts	3 to 60 V	3 to 240 V
Maximum power (at 40° C)	300 W	250 W
Constant current mode		
Ranges	0 to 6 A, 0 to 60 A	0 to 1 A, 0 to 10 A
Accuracy	0.1% ±75 mA	0.15% ±10 mA
Regulation	10 mA	8 mA
Constant voltage mode		
Accuracy	0.1% ±50 mV	0.12% ±120 mV
Regulation (w/remote sense)	10 mV	10 mV
Constant resistance mode		
Ranges	1 to 1,000 Ω 10 to 10,000 Ω	24 to 10,000 Ω 240 to 50,000 Ω
Accuracy	1 Ω: 0.8% ±8 mΩ (with ≥6 A at input) 1 KΩ: 0.3% ±8 mS (with ≥6 V at input) 10 KΩ: 0.3% ±8 mS (with ≥6 V at input)	24 Ω: 0.8% ±200 mΩ (with ≥1 A at input) 10 KΩ: 0.3% ±0.3 mS (with ≥24 V at input) 50 KΩ: 0.3% ±0.3 mS (with ≥24 V at input)
Transient generator		
Frequency range	0.25 Hz to 10 kHz	0.25 Hz to 10 kHz
Accuracy	3%	3%
Duty cycle range	3 to 97% (0.25 Hz to 1 kHz) 6 to 94% (1 to 10 kHz)	3 to 97% (0.25 Hz to 1 kHz) 6 to 94% (1 to 10 kHz)
Accuracy	6% of setting ±2%	6% of setting ±2%
Current level high range	60-A range:	10-A range:
Accuracy	0.1% ±350 mA	0.18% ±50 mA
Current level low range	6-A range:	1-A range:
Accuracy	0.1% ±80 mA	0.18% ±13 mA
Voltage level	3 to 60 V	3 to 240 V
Voltage level accuracy	0.1% ±300 mV	0.15% ±1.1 V
Readback specifications		
Current readback accuracy	0.05% ±65 mA	0.12% ±10 mA
Voltage readback accuracy	±(0.05% + 45 mV)	±(0.1% + 150 mV)
Ripple and noise (20 Hz to 10 MHz noise)		
Current	4 mArms 40 mA peak-to-peak	1 mArms 10 mA peak-to-peak
Voltage	6 mVrms	6 mVrms

Single-Input: 250 W to 300 W (Continued)

Specifications

6060B

6063B

Notes:

1. Operating temperature range is 0° to 55°C. All specifications apply for 25°C ±5°C, except as noted.
2. Maximum continuous power available is derated linearly from 40°C to 75% of maximum at 55°C.
3. DC current accuracy specifications apply 30 seconds after input is applied.

Supplemental Characteristics

(Non-warranted characteristics determined by design that are useful in applying the product)

	6060B	6063B
Constant current mode		
Resolution	60-A range: 16 mA 6-A range: 1.6 mA	10-A range: 2.6 mA 1-A range: 0.26 mA
Temperature coefficient	100 ppm/°C ±5 mA/°C	150 ppm/°C ±1 mA/°C
Constant voltage mode		
Resolution	16 mV	64 mV
Temperature coefficient	100 ppm/°C ±5 mV/°C	120 ppm/°C ±10 mV/°C
Constant resistance mode		
Resolution	1 Ω: 0.27 mΩ 1 KΩ: 0.27 ms 10 KΩ: 0.027 ms	24 Ω: 6 mΩ 10 KΩ: 0.011 ms 50 KΩ: 0.001 ms
Temperature coefficient	1 Ω: 800 ppm/°C ±0.4 mΩ/°C 1 KΩ: 300 ppm/°C ±0.6 ms/°C 10 KΩ: 300 ppm/°C ±0.6 ms/°C	24 Ω: 800 ppm/°C ±10 mΩ/°C 10 KΩ: 300 ppm/°C ±0.03 ms/°C 50 KΩ: 300 ppm/°C ±0.03 ms/°C
Transient generator		
Frequency range	0.25 Hz to 10 kHz	0.25 Hz to 10 kHz
Resolution	4% or less	4% or less
Duty cycle range	3 to 97% (0.25 Hz to 1 kHz) 6 to 94% (1 to 10 kHz)	3 to 97% (0.25 Hz to 1 kHz) 6 to 94% (1 to 10 kHz)
Resolution	4%	4%
Current level high range	60-A range: 260 mA	10-A range: 43 mA
Current level low range	6-A range: 26 mA	1-A range: 4 mA
Current temperature coefficient	100 ppm/°C ±7 mA/°C	180 ppm/°C ±1.2 mA/°C
Voltage level resolution	260 mV	1 V
Voltage temperature coefficient	150 ppm/°C ±5 mV/°C	120 ppm/°C ±10 mV/°C
Programmable slew rate	60-A range: 1 A/ms to 5 A/μs 6-A range: 0.1 A/ms to 0.5 A/μs	10-A range: 0.17 A/ms to 0.83 A/μs 1-A range: 17 A/ms to 83 A/ms
Rise/fall time	12 μs to 8 ms	16 μs to 8 ms
Analog programming bandwidth	10 kHz (–3 dB frequency)	10 kHz (–3 dB frequency)
Analog programming accuracy		
Current (low range)	4.5% ±75 mA	3% ±8 mA
Current (high range)	4.5% ±250 mA	3% ±20 mA
Temperature coefficient	100 ppm/°C ±6 mA/°C	150 ppm/°C ±1 mA/°C
Voltage	0.8% ±200 mV	0.5% ±150 mV
Temperature coefficient	100 ppm/°C ±1 mV/°C	120 ppm/°C ±10 mV/°C
Analog programming voltage	0 to 10 V	0 to 10 V
Readback specifications		
Current readback resolution	17 mA (via GPIB) 20 mA (front panel)	2.7 mA (via GPIB) 10 mA (front panel)
Temperature coefficient	50 ppm/°C ±5 mA/°C	100 ppm/°C ±1 mA/°C
Voltage readback resolution	17 mV (via GPIB) 20 mV (front panel)	67 mV (via GPIB) 100 mV (front panel)
Temperature coefficient	50 ppm/°C ±1.2 mV/°C	100 ppm/°C ±8 mV/°C

Single-Input: 250 W to 300 W (Continued)

Specifications

6060B

6063B

Notes:

1. Operating temperature range is 0° to 55°C. All specifications apply for 25°C ±5°C, except as noted.
2. Maximum continuous power available is derated linearly from 40°C to 75% of maximum at 55°C.
3. DC current accuracy specifications apply 30 seconds after input is applied.

Supplemental Characteristics

(Non-warranted characteristics determined by design that are useful in applying the product)

(Continued)

Supplemental Characteristics			
Analog monitor accuracy			
Current monitor (0 to 10 V _{out})	4% ±85 mA	3% ±10 mA	
Temperature coefficient	50 ppm/°C ±6 mA/°C	100 ppm/°C ±1 mA/°C	
Voltage monitor (0 to 10 V _{out})	0.25% ±40 mV	0.4% ±240 mV	
Temperature coefficient	50 ppm/°C ±0.2 mV/°C	70 ppm/°C ±1.2 mV/°C	
Remote sensing	5-VDC maximum between sense and load input	5-VDC maximum between sense and load input	
Minimum operating voltage (at full rated current)	2 volts (1.2 V typical)	2 volts (1.2 V typical)	
Programmable short	0.033 Ω (0.020 Ω typical)	0.20 Ω (0.10 Ω typical)	
Programmable open (typical)	20 kΩ	80 kΩ	
Drift (over 8-hour interval)			
Current	0.03% ±10 mA	0.03% ±15 mA	
Voltage	0.01% ±10 mV	0.01% ±20 mV	
DC isolation voltage	±240 VDC, between any input and chassis ground	±240 VDC, between any input and chassis ground	
Digital inputs	V _{IL} = 0.9 V _{max} at I _L = -1 mA / V _{IH} = 3.15 V _{min} (pull-up resistor on input)	V _{IL} = 0.9 V _{max} at I _L = -1 mA / V _{IH} = 3.15 V _{min} (pull-up resistor on input)	
Digital outputs	V _{OL} = 0.72 V _{max} at I _{OL} = 1 mA / V _{OH} = 4.4 V _{min} at I _{OH} = -20 μA	V _{OL} = 0.72 V _{max} at I _{OL} = 1 mA / V _{OH} = 4.4 V _{min} at I _{OH} = -20 μA	
Net weight (approx.)	6.12 kg (13.5 lb)	6.12 kg (13.5 lb)	
Shipping weight	8.16 kg (18 lb)	8.16 kg (18 lb)	

Single-Input: 250 W to 300 W (Continued)

Application notes

Agilent AN 372-1 Power Supply Testing
(AN 372-1)
5952-4190

Agilent AN 372-2 Battery Testing
(AN 372-2)
5952-4191

Pulsed Characterization of Power Semiconductors Using Electronic Loads
(AN 1246)
5091-7636E

Ordering information

- Opt 020** Front panel DC input connectors
- Opt 100** 87 to 106 VAC, 47 to 66 Hz input (for Japan only)
- Opt 120** 104-127 VAC, 47 to 66 Hz
- Opt 220** 191 to 233 VAC, 47 to 66 Hz input
- Opt 240** 209 to 250 VAC, 47 to 66 Hz input
- Opt 0L1** English printed operating manual and programming guide (full documentation on CD-ROM)
- Opt 0B3** English printed service manual

Accessories

- * **1CM002A** Rack mount flange kit 88.1 mm H (2U) - two flange brackets; 1.75 in hole spacing
- * **1CP001A** Rack mount flange and handle kit 88.1 mm H (2U) - two brackets and front handles
- E3663AC** Support rails for Agilent rack cabinets
- * Support rails or slides are required

Supplemental characteristics for all model numbers

Software driver:
VXIPlug&Play

Weight: 6.12 kg (13.5 lb) net;
8.16 kg (18 lb) shipping

Size: 425.5 mm W x 88.1 mm H x 396 mm D (16.75 in x 3.5 in x 13.7 in)

Warranty: Three years

Agilent Models: 6060B, 6063B

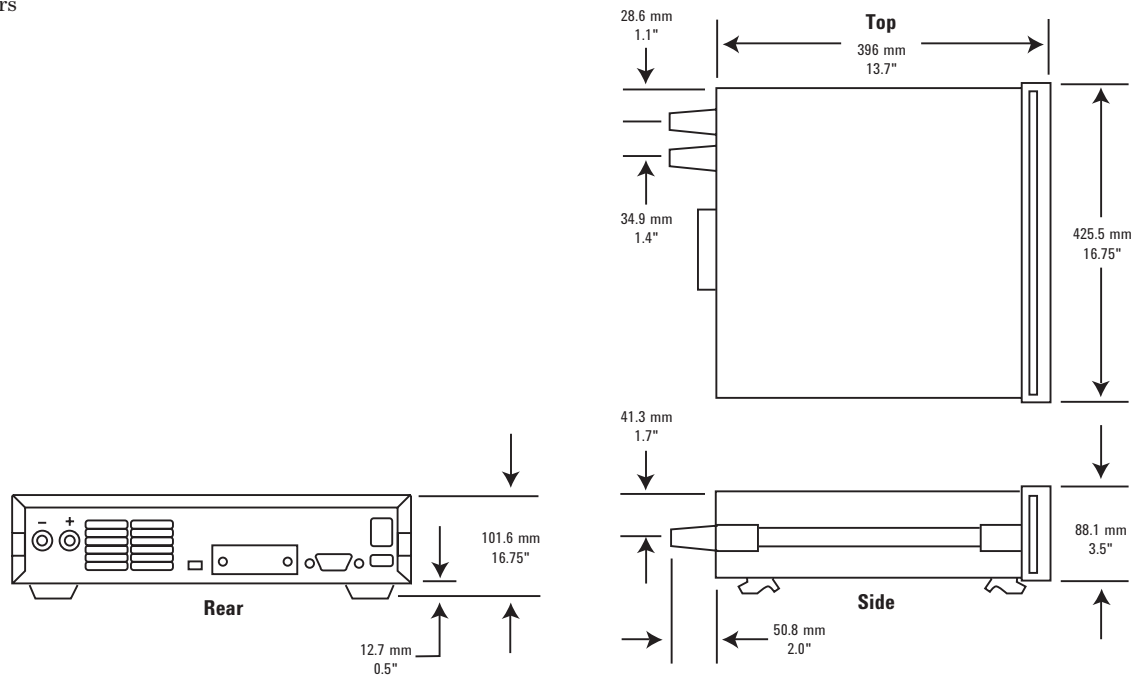

More detailed specifications at www.agilent.com/find/6060

AC Power Source/Analyzers...

an integrated
AC power solution

Agilent AC power source/analyzers provide a complete AC test solution. As AC sources, they combine the capabilities of a power amplifier and an arbitrary waveform generator. This allows you to simulate normal waveforms and many types of distorted power waveforms. The built-in power analyzer combines the capabilities of a multimeter, oscilloscope, harmonic analyzer and power analyzer. These instruments may also be used to produce DC power, either alone or as a DC offset to an AC waveform.

AC Power Source/Analyzers 375-1750 VA



6811B, 6812B, 6813B

Provides a complete AC and DC power and measurement solution
Protect valuable DUTs with extensive protection features
Easy to use Graphical User Interface (GUI)

The Complete AC Power Test Solution

Since your product will have to operate in the real world of unpredictable AC power, you need to design and verify its correct operation under a wide range of AC power inputs. Brownouts, dropouts, sags, and other irregularities are not unusual in many communities today. Agilent AC sources have the features needed to easily accomplish this test goal either in an R&D environment or on the manufacturing test floor. If you plan to sell your products in a worldwide market, you will also need to test them at the line voltages and frequencies that they will eventually operate at. There is also additional testing needed to meet regulatory requirements for sale into some countries.

Agilent AC sources offer a complete solution for AC power testing, helping you to simplify this important task. These instruments combine the features of a power amplifier and arbitrary waveform generator to give you the ability to do all of the tests that you need. There are many standard preprogrammed waveforms, or you can use the

transient generation system to simulate sophisticated and repeatable AC line disturbances. DC power can also be generated, either as a DC offset or as a pure DC signal.

Powerful Built-in Measurement Capabilities

Agilent AC sources have extensive 16-bit precision measurement capabilities which would normally require a number of complex measurement instruments, including a DMM (digital multimeter), oscilloscope, power analyzer, and harmonic analyzer. The precision measurements include:

- rms, DC, AC + DC voltage and current
- peak voltage and current
- real, apparent, and reactive power
- harmonic analysis of voltage and current waveforms providing amplitude and phase up to the 50th harmonic
- THD (total harmonic distortion)
- Triggered acquisition of digitized voltage and current

Using the measurement capabilities of an Agilent AC source simplifies your test setups and helps you obtain accurate data quickly.

Dual Power Analyzer Option 020

The powerful built-in power meter/analyzer in Agilent AC sources provides everything that you need to make AC measurements at the AC input to your DUT. For many test scenarios, this is the extent of the AC analysis required.

Some test scenarios, however, require AC measurements to be made at both the AC input and the AC output of the DUT. Option 020 provides an additional power analyzer, complete with a precision current shunt, which can be connected anywhere you need it. This second analyzer can even be used for tests where the AC source is not providing power, thus expanding the usefulness of this instrument to many more test configurations. The additional analyzer is equivalent in specifications and capabilities to the standard analyzer.

AC Power Source/Analyzers: 375-1750 VA (Continued)

Using the dual power analyzer option instead of an additional power analyzer instrument externally is more than just convenient. Measurements on all four measurement channels (AC source output voltage and current, and dual power analyzer voltage and current inputs) are inherently synchronized with the AC source output waveform. This precision would be difficult to achieve using separate measurement instruments.

Examples dual power analyzer applications

- Complete testing of uninterruptible power sources (UPS)
- Efficiency testing of DC power supplies
- Efficiency testing of AC power sources
- Efficiency testing of transformers
- Safety testing of transformers
- Line disturbance and brownout testing of DC power supplies
- Line disturbance and brownout testing of AC power sources
- Sleep mode current monitoring
- Independent power analyzer

Sleep mode current monitoring

Many electronic products have power-saving or sleep modes. In this mode, the device draws only enough power to be able to recognize a “wake-up” signal, and then execute a smooth “wake-up”. The power drawn in this mode is a critical parameter, and the ability to accurately monitor it is important.

The accessory precision current shunt that is supplied with option 020 is mounted in such a way to make it easy for you to replace it with a precision resistor of your choice. By doing this, you can configure the system to accurately monitor extremely low currents. This provides an easy way for you to profile the current draw in all modes of your product’s operation. Since Agilent 6811B-6813B AC sources produce DC power as well as AC power, portable battery operated products can also be tested with this configuration.

UPS (uninterruptible power source) testing

The Dual Power Analyzer Option provides many important benefits for UPS testing. Since the key to correct UPS operation is having the output react properly to changes on the input, being able to monitor the output relative to the input simplifies testing. For example, commands are available to enable calculation of UPS transfer time, and the phase difference between the UPS input and output voltage. Agilent AC sources also have programmable output impedance, enabling the UPS designer to verify product stability over a wide range of AC line impedance.

Free Graphical User Interface (GUI)

When you need to run a variety of tests, study the results carefully, and then run more tests with slightly varied conditions, writing computer programs using the extensive SCPI command set may seem burdensome. This is when you should download the latest copy of the free Agilent AC Source Graphical User Interface from www.agilent.com.

The Agilent AC source GUI makes it quick and easy to set the output of your Agilent AC source, be it from a stored waveform or with a waveform that you create using your mouse. The GUI also allows you to see the output of the AC source in graphical form, save the results, or dump them directly into a Microsoft Excel file.

Microsoft Excel link

The direct Excel link feature was recently added to meet the current needs of R&D engineers. It makes it easy to keep the results of many tests, and makes them easily retrievable. With it, the test records resulting from changing conditions can be kept in one place and easily compared.

Access to raw data often helps in fully understanding test results. For example, small local peaks may not be evident in processed data. V, I and phase results from harmonic measurements are particularly susceptible to not showing the complete story in a graphical representation.

AC Power Source/Analyzers: 375-1750 VA (Continued)

Microsoft Excel offers a wide variety of data manipulation and graphical capabilities that can help an engineer gain the fullest understanding from the test data.

Test Suite for avionics equipment

Agilent AC sources are well suited for testing equipment intended for use in the avionics industry which operate at nominally 400 Hz. One of the special requirements that many manufacturers in this industry must concern themselves with is testing to meet RTCA DO-160 standards. These standards involve both AC and DC immunity tests. The Agilent AC source GUI includes a section devoted to these tests. By using this tool, you can quickly step through the required set-ups with confidence.

Extensive Protection to Prevent Load Damage

In addition to overcurrent, overvoltage, overpower and overtemperature protection, the 6800 series offers output disconnect relays and remote inhibit capability (quickly

disabling the output of the AC source via a TTL signal) to protect the device under test.

The 6800 series is backed by a three-year warranty and Agilent's worldwide network of support and service centers.

Application Information

The 6800 series can help you test and improve your products. You can easily perform:

1. Static testing—generating and measuring voltage, frequency, and line current for meeting worldwide specifications.
2. Dynamic testing—generating AC line transients for limit testing and design verification.
3. Specialty testing—measuring current harmonic content and creating custom AC power waveforms (such as a combined AC + DC signal to simulate a telephone ring).
4. Precompliance regulatory testing—measuring current harmonics, voltage fluctuations and flicker emissions and generating voltage and frequency disturbances and interharmonics to determine product immunity.

Development engineers and test professionals in a wide variety of industries use AC power source/analyzers. Here are a few examples:

Avionics

Instrumentation, ATE test stations

Computer products

Computers, monitors, peripherals

Consumer products

Home appliances, audio and video equipment, heating/cooling controls

Electrical products

Relays, transformers, power components, fire alarms

Lighting products

Electronic ballasts, compact fluorescent bulbs, timers

Motors

AC motors, electronic controllers

Power products

AC/DC adapters, AC/DC power supplies, PBX power supplies, Uninterruptible power supplies

Telecom products

RF amplifiers, CATV devices, MUX's, routers, switches

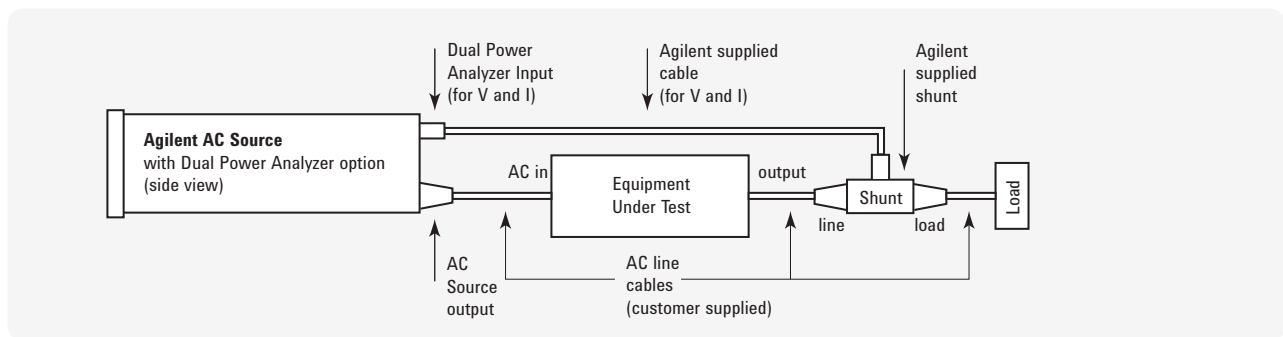

Test configuration of efficiency measurement using an Agilent AC source with the 020 Dual Power Analyzer Option.

AC Power Source/Analyzers: 375-1750 VA (Continued)

AC Source Graphical User Interface

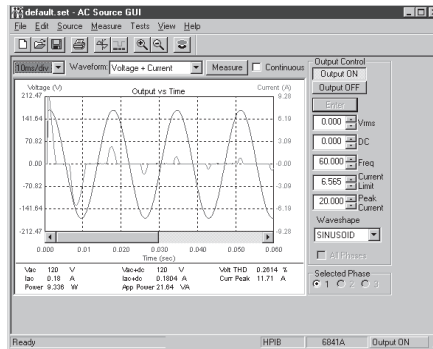

Inrush current measurement

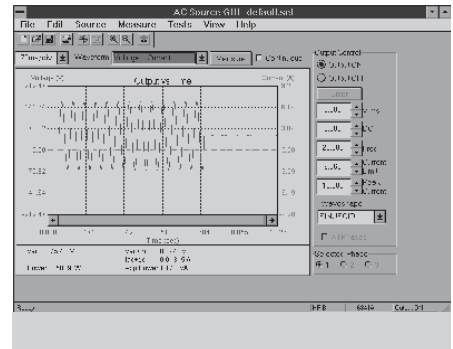

Ringer voltage (DC + AC) generation

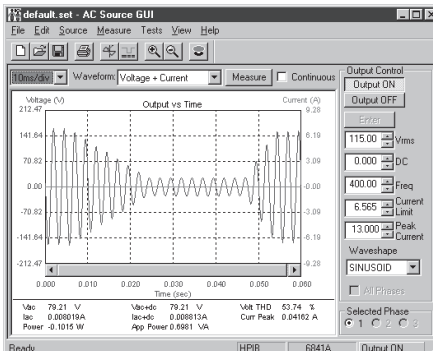

Voltage slew control (brownout)

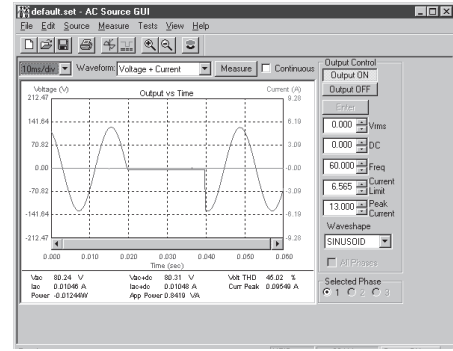

One cycle AC mains dropout

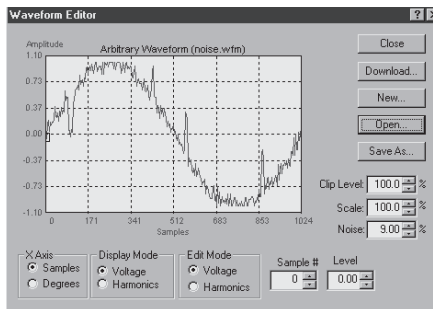

User defined waveform: noise with spikes

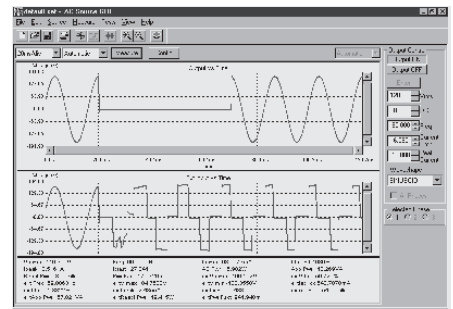

Testing of UPS input and output using dual power analyzer Option 020

AC Power Source/Analyzers: 375-1750 VA (Continued)

For a sine wave with a resistive load at 0° to 40°C, within an output frequency range of 45 Hz to 1000 Hz, and in AC coupled mode after a 30 minute warm-up unless otherwise noted.

Notes:

¹ Product may be operated between DC and 45 Hz subject to certain deratings. Measurements may be extended to 4.5 Hz at full accuracy only by selecting a digitization rate of 250 μs per point. Frequency content of the measured signal must be limited to 4 kHz or less to avoid aliasing effects.

Specifications (at 0° to 55°C unless otherwise specified)	6811B	6812B	6813B
Number of phases	1	1	1
Output ratings (Maximum)			
Power	375 VA	750 VA	1750 VA
rms voltage	300 V	300 V	300 V
rms current	3.25 A	6.5 A	13 A
Repetitive & non-repetitive peak current	40 A	40 A	80 A
Crest factor	12	6	6
Load power factor capability	0 to 1	0 to 1	0 to 1
DC power	285 W	575 W	1350 W
DC voltage	±425 V	±425 V	±425 V
DC current	2.5 A	5.0 A	10.0 A
Output frequency range¹	DC; 45 Hz to 1 kHz	DC; 45 Hz to 1 kHz	DC; 45 Hz to 1 kHz
Constant voltage ripple and noise (20 kHz to 10 MHz)	-60 dB (relative to full scale)	-60 dB (relative to full scale)	-60 dB (relative to full scale)
Line regulation (% of full scale)	0.1%	0.1%	0.1%
Load regulation (% of full scale)	0.5%	0.5%	0.5%
Maximum total harmonic distortion	0.25% at 50/60 Hz 1% worst case 45 to 1 kHz	0.25% at 50/60 Hz 1% worst case 45 to 1 kHz	0.25% at 50/60 Hz 1% worst case 45 to 1 kHz
Programming accuracy (25° ± 5°C)			
RMS voltage (% of output + offset)	0.15% + 0.3 V (45 - 100 Hz) 0.5% + 0.3 V (>100 - 500 Hz) 1% + 0.3 V (> 500 - 1000 Hz)	0.15% + 0.3 V (45 - 100 Hz) 0.5% + 0.3 V (>100 - 500 Hz) 1% + 0.3 V (> 500 - 1000 Hz)	0.15% + 0.3 V (45 - 100 Hz) 0.5% + 0.3 V (>100 - 500 Hz) 1% + 0.3 V (> 500 - 1000 Hz)
DC voltage	0.1% + 0.5 V	0.1% + 0.5 V	0.5% + 0.3 V
Frequency	0.01% + 10 μHz	0.01% + 10 μHz	0.01% + 10 μHz

AC Power Source/Analyzers: 375-1750 VA (Continued)

Specifications

(at 0° to 55°C unless otherwise specified)

6811B

6812B

6813B

For a sine wave with a resistive load at 0° to 40° C, within an output frequency range of 45 Hz to 1000 Hz, and in AC coupled mode after a 30 minute warm-up unless otherwise noted.

Notes:

¹ Product may be operated between DC and 45 Hz subject to certain deratings. Measurements may be extended to 4.5 Hz at full accuracy only by selecting a digitization rate of 250 μ seconds per point. Frequency content of the measured signal must be limited to 4 kHz or less to avoid aliasing effects.

² Select low measurement range for improved accuracy (10:1) for lower power measurements.

Measurement Accuracy

(25°C ±55°C)

Rms. voltage (45 - 100 Hz)	0.03% + 100 mV ¹	0.03% + 100 mV ¹	0.03% + 100 mV ¹
DC voltage	0.05% + 150 mV ¹	0.05% + 150 mV ¹	0.05% + 150 mV ¹
RMS current (45 - 100 Hz)²			
High range	0.05% + 10 mA	0.05% + 10 mA	0.05% + 10 mA
Low range	0.05% + 1.5 mA	0.05% + 1.5 mA	0.05% + 1.5 mA
Power (VA) (45-100 Hz)²			
High range	0.1% + 1.5 VA + 12 mVA/V	0.1% + 1.5 VA + 12 mVA/V	0.1% + 1.5 VA + 12 mVA/V
Low range	0.1% + 1.5 VA + 1.2 mVA/V	0.1% + 1.5 VA + 1.2 mVA/V	0.1% + 1.5 VA + 1.2 mVA/V
Power (watts) (45-100 Hz)²			
High range	0.1% + 0.3 W + 12 mW/V	0.1% + 0.3 W + 12 mW/V	0.1% + 0.3 W + 12 mW/V
Low range	0.1% + 0.3 W + 1.2 mW/V	0.1% + 0.3 W + 1.2 mW/V	0.1% + 0.3 W + 1.2 mW/V
Frequency	0.01% + 0.01 Hz	0.01% + 0.01 Hz	0.01% + 0.01 Hz
Power factor	0.01	0.01	0.01
Current magnitude Fundamental	0.03% + 1.5 mA	0.03% + 1.5 mA	0.03% + 1.5 mA
Low range Harmonics 2-49	0.03% + 1 mA + 0.2%/kHz	0.03% + 1 mA + 0.2%/kHz	0.03% + 1 mA + 0.2%/kHz
Current magnitude Fundamental	0.05% + 5 mA	0.05% + 5 mA	0.05% + 5 mA
High range Harmonics 2-49	0.05% + 3 mA + 0.2%/kHz	0.05% + 3 mA + 0.2%/kHz	0.05% + 3 mA + 0.2%/kHz

Supplemental Characteristics

(Non-warranted characteristics determined by design that are useful in applying the product)

Average programming accuracy (% of output + offset) rms current	1.2% + 50 mA	1.2% + 50 mA	1.2% + 50 mA
Average programming resolution			
rms voltage	125 mV	125 mV	125 mV
DC voltage	250 mV	250 mV	250 mV
Oversvoltage programming (OVP)	2 V peak	2 V peak	2 V peak
rms current	2 mA	4 mA	4 mA
Peak current	12.5 mA	25 mA	25 mA
Output frequency	10 μHz	10 μHz	10 μHz
Phase	N/A	N/A	N/A

AC Power Source/Analyzers: 375-1750 VA (Continued)

Specifications

(at 0° to 55°C unless otherwise specified)

6811B

6812B

6813B

For a sine wave with a resistive load at 0° to 40° C, within an output frequency range of 45 Hz to 1000 Hz, and in AC coupled mode after a 30 minute warm-up unless otherwise noted.

AC input ratings notes:

- ¹ Measured at low line
- ² Measured at high line

Application notes

**Agilent 6800 Series
AC Power Source/Analyzer**
5963-7044E

**Testing Uninterruptible Power
Supplies Using Agilent 6800 Series
AC Power Source/Analyzers**
5967-6056E

**Simplify your Avionics Testing with a
400 Hz Single Phase Power Source that
includes a Built-in 26 V reference signal**
5989-3700EN

Software driver:
VXIPlug&Play

Warranty: Three years

Supplemental Characteristics

(Continued)

(Non-warranted characteristics determined by design that are useful in applying the product)

Average measurement resolution			
rms voltage	10 mV	10 mV	10 mV
rms current	2 mA	2 mA	2 mA
Programmable output impedance			
Resistance	0-1 Ω	0-1 Ω	0-1 Ω
Inductance	20 μh - 1 mh	20 μh - 1 mh	20 μh - 1 mh
Remote sense capability	Up to 1 Vrms can be dropped across each load lead.	Up to 1 Vrms can be dropped across each load lead.	Up to 1 Vrms can be dropped across each load lead.
Isolation to ground	300 Vrms/425 VDC	300 Vrms/425 VDC	300 Vrms/425 VDC
Net weight	28.2 kg (62 lb)	28.2 kg (62 lb)	32.7 kg (72 lb)
Shipping weight	31.8 kg (70 lb)	31.8 kg (70 lb)	36.4 kg (80 lb)
Dimensions	See drawings on page 178		

AC Input Ratings

Voltage range (VAC) *default factory setting	87 to 106 VAC *104 to 127 VAC 174 to 220 VAC 191 to 254 VAC	87 to 106 VAC *104 to 127 VAC 174 to 220 VAC 191 to 254 VAC	174 to 220 VAC *191 to 254 VAC
Maximum input current (rms) ¹	12 A (100 VAC) 10 A (120 VAC) 7.5 A (200/208 VAC) 6.5 A (230 VAC)	28 A (100 VAC) 24 A (120 VAC) 15 A (200/208 VAC) 13 A (230 VAC)	22 A (200/208 VAC) 20 A (230 VAC)
Input power (max) ²	1000 VA/700 W	2500 VA/1400 W	3800 VA/2600 W
Input frequency	47 to 63 Hz	47 to 63 Hz	47 to 63 Hz

AC Power Source/Analyzers: 375-1750 VA (Continued)

Ordering information

Opt 019 2000 VA AC power source/ analyzer (6813B only)

Opt 020 Dual power analyzer option

Opt 026 26 Volt, 0.1A auxiliary 45 to 100 Hz only reference output (6812B and 6813B)

OL1 English printed users, programming, quick start guides, reference card (full documentation on CD-ROM)

Opt 100 (6811B and 6812B only) 87 to 106 VAC (100 VAC nominal), 47-63 Hz, Japan only

Opt 120 104-127 VAC (120 VAC nominal), 47-63 Hz

Opt 200 (6813B only) 174-220 VAC (200 VAC nominal), 47-63 Hz, Japan only

Opt 208 (6811B and 6812B only) 174 to 220 VAC (208 VAC nominal), 47-63 Hz

Opt 230 191 to 254 VAC (230 VAC nominal), 24-63 Hz

Opt 831 12 AWG, 200 to 240 VAC, unterminated (6812B, 6813B only)

Opt 832 4 mm² wire size, unterminated (6813B only)

Opt 833 1.5 mm² wire size, 200 to 240 VAC, unterminated (6812B only)

Opt 834 10 AWG, 100 to 120 VAC, unterminated (6812B only)

Opt 841 Line cord with NEMA L6-20P; 20 A, 250 V plug (6812B only)

Opt 842 Line cord with IEC 309; 32 A, 220 V plug (6813B only)

Opt 844 Line cord with NEMA L6-30P; 30 A, 250 V locking plug (6813B only)

Opt 845 Line cord with IEC 309; 16 A, 220 V plug (6812B only)

Opt 846 Line cord with NEMA L6-30P; 30 A, 120 V plug (6812B only)

Opt 847 Line cord with CEE 7/7; 16 A, 220 V plug (6812B only)

Opt 848 Line cord with BS 546; 15 A, 240 V plug (6812B only)

See the AC line voltage and cord section, for more details on line cords.

Accessories

* **1CM003A** Rack mount flange kit 132.6 mm H (3U) - two flange brackets

* **1CP002A** Rack mount flange and handle kit 132.6 mm H (3U) - two brackets and front handles

E3663AC Support rails for Agilent rack cabinets

* Support rails required

Agilent Models: 6811B, 6812B, 6813B

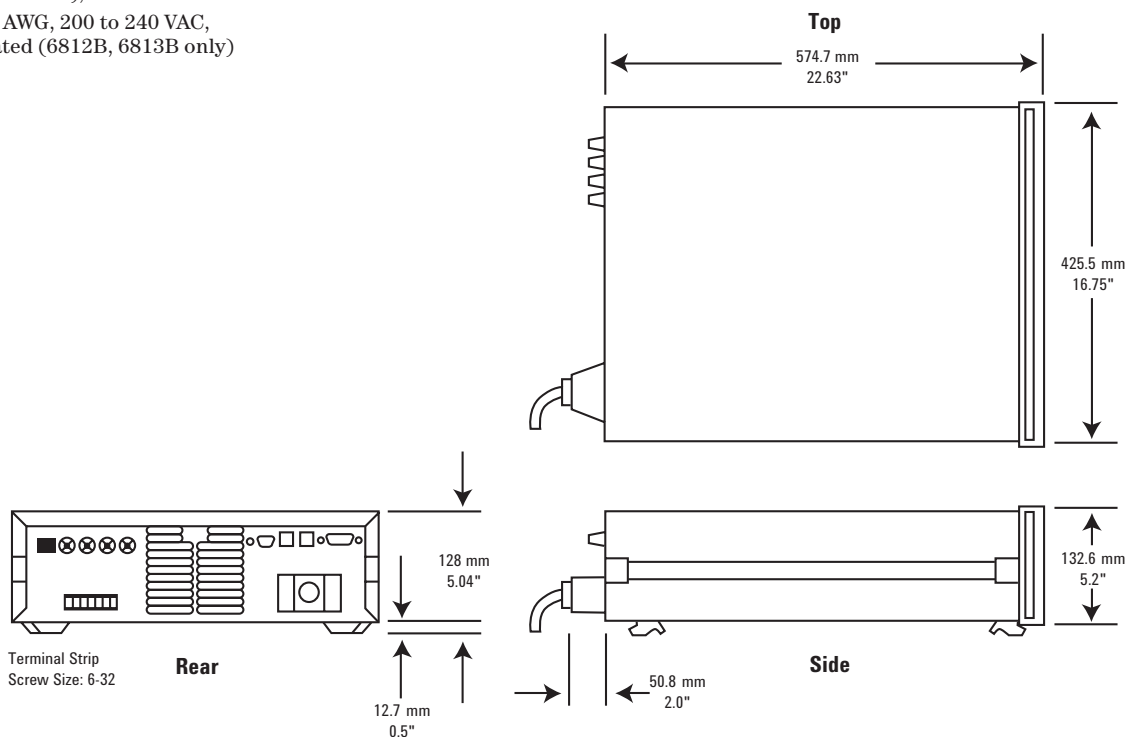

More detailed specifications at www.agilent.com/find/6800

Choosing AC Line Voltage and Cord Options for your Agilent Power Products

DC Power Supplies, DC Electronic Loads, and AC Sources

4 Easy Steps for Choosing Line Cord Options

Choosing AC Line Voltage and Cord Options for Your Power Product

Power distribution systems, regulations, and connection techniques vary greatly among geographic regions as a result of local AC electrical standards. Most Agilent products, including power products which draw less than 500 watts of power from the AC line, can be readily adjusted to accept different line voltages or frequencies.

Line voltage and frequency for certain power products may not be field changeable. Choosing the correct voltage option for these products requires care. This is especially true for higher power products.

Step 1

Go to the tables. Find the model number and the correct line cord option of the product you are ordering.

Line cords for low power products

Step 2

If your model number requires a 900 series line cord, the correct one will automatically be shipped for the destination country on the purchase order. DONE!

Line cords for high power products

Step 3

If your model number requires an 800 series line cord, determine if there is a line cord with plug that matches your outlet receptacle. If not, choose the appropriate unterminated line cord.

Step 4

Add the option number for the appropriate line cord to your purchase order. DONE!

Choosing AC Line Voltage and Cord Options for your Agilent Power Products





DC Power Supplies, DC Electronic Loads, and AC Sources (Continued)

Low power products

For lower power products, a universal receptacle on the rear panel accepts a wide range of line cords to meet local regulatory requirements. The tables containing the 900 series line cords show a range of standard line cords that Agilent offers, with option numbers and part numbers.

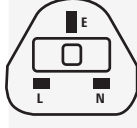
Part numbers are needed to order a line cord separately.

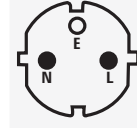
For products which use the 900 series line cords, the appropriate type is automatically selected at time of shipment, based on the country to which the product is being shipped. If you plan to use your power products in a different country or region than the country to which the product is being shipped, you will need to specify the appropriate line voltage and line cord options on your order, so that we can provide the appropriate configuration. Contact your local Agilent Field Engineer for assistance.

Cord Options	900	901	902	903	904
Product/Family					
	United Kingdom	Australia New Zealand	Europe Korea	United States Canada	United States Canada
6033A, 38A	8120-1351	8120-1369	8121-1226	8120-4383	8120-0698
6060B, 63B	8120-1351	8120-1369	8121-1226	8120-4383	8120-0698
6541A - 45A	8120-1351	8120-1369	8121-1226	8120-4383	8120-0698
6551A - 55A	8120-1351	8120-5412	8121-1226	8120-5337	8120-5421
6611C - 14C	8120-8705	8120-1369	8121-1226	8120-4383	8120-0698
6621A - 6629A	8120-1351	8120-1369	8121-1226	8120-4383	8120-0698
6631B - 34B	8120-8705	8120-1369	8121-1226	8120-4383	8120-0698
6641A - 45A	8120-1351	8120-1369	8121-1226	8120-4383	8120-0698
6651A - 55A	8120-1351	8120-5412	8121-1226	8120-5337	8120-5421
6811B	8120-1351	8120-5412	8121-1226	8120-5337	8120-5421
66309B/D	8120-8705	8120-1369	8121-1226	8120-4383	8120-0698
66311B	8120-8705	8120-1369	8121-1226	8120-4383	8120-0698
66319B/D	8120-8705	8120-1369	8121-1226	8120-4383	8120-0698
66321B/D	8120-8705	8120-1369	8121-1226	8120-4383	8120-0698
66332A	8120-8705	8120-1369	8121-1226	8120-4383	8120-0698
E3620A	8120-4420	8120-4419	8121-1226	8120-8767	8120-3996
E3630A	8120-4420	8120-4419	8121-1226	8120-8767	8120-3996
E3631 - 34A	8120-4420	8120-4419	8121-1226	8120-8767	8120-3996
E3640 - 49A	8120-4420	8120-4419	8121-1226	8120-8767	8120-3996
E4360A	8120-1351	8120-1369	8121-2145	8120-5337 ¹	8120-5338
N5741A - 52A	8120-4420	N/A	8121-1226	8120-5337	N/A
N6700B, N6701A - 02A N6705B	8120-1351	8120-1369	8121-2145	8120-5337 ¹	8120-5338
N6950 - 54A N7950 - 54A	8120-1351	8120-1369	8121-2145	8120-5337	8120-5338
N6970 - 77A N7970 - 77A	8121-2363	8121-2359	8121-2360	8121-2355	8121-2356
N3300A - 31A	8120-1351	8120-1369	8121-1226	8120-4383	8120-0698

L = Line or active conductor (also called "live" or "hot")





N = Neutral or identified conductor

E = Earth or safety ground

¹ For models E4360A and N6702A: Using 100-120 VAC limits total output power to 600 W. 200-240 VAC line is required to permit full 1200 W operation.

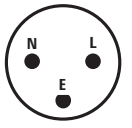
Choosing AC Line Voltage and Cord Options for your Agilent Power Products

DC Power Supplies, DC Electronic Loads, and AC Sources (Continued)

Cord Options	906	912	917	918	919
Product/Family	    				
	Switzerland	Denmark	India	Japan	Israel
6033A, 38A	8120-2104	8120-2956	8120-4211	8120-4753	8120-6800
6060B, 63B	8120-2104	8120-2956	8120-4211	8120-4753	8120-6800
6541A - 45A	8120-2104	8120-2956	8120-4211	8120-4753	8120-6800
6551A - 55A	8120-2104	8120-2956	8120-5414	8120-5342	8120-6800
6611C - 14C	8120-2104	8120-2956	8120-4211	8120-4753	8120-6800
6621A - 6629A	8120-2104	8120-2956	8120-4211	8120-4753	8120-6800
6631B - 34B	8120-2104	8120-2956	8120-4211	8120-4753	8120-6800
6641A - 45A	8120-2104	8120-2956	8120-4211	8120-4753	8120-6800
6651A - 55A	8120-2104	8120-2956	8120-5414	8120-5342	8120-6800
6811B	8120-2104	8120-2956	8120-5414	8120-5342	8120-6800
66309B/D	8120-2104	8120-2956	8120-4211	8120-4753	8120-6800
66311B	8120-2104	8120-2956	8120-4211	8120-4753	8120-6800
66319B/D	8120-2104	8120-2956	8120-4211	8120-4753	8120-6800
66321B/D	8120-2104	8120-2956	8120-4211	8120-4753	8120-6800
66332A	8120-2104	8120-2956	8120-4211	8120-4753	8120-6800
E3620A	8120-2104	8120-4521	8120-4211	8120-4753	8121-1662
E3630A	8120-2104	8120-4521	8120-4211	8120-4753	8121-1662
E3631 - 34A	8120-2104	8120-4521	8120-4211	8120-4753	8121-1662
E3640 - 49A	8120-2104	8120-4521	8120-4211	8120-4753	8121-1662
E4360A	8120-2104	8120-2956	8120-4211	8120-5342 ¹	8121-2542
N5741A - 52A	N/A	N/A	N/A	8120-5342	N/A
N6700B, N6701A - 02A, N6705B	8120-2104	8120-2956	8120-4211	8120-5342	8121-2542
N6950 - 54A, N7950 - 54A	8120-2104	8120-2956	8120-4211	8120-5342	8121-0724
N6970 - 77A, N7970 - 77A	8121-2362	8121-2363	8121-2367	8121-2377	8121-2368
N3300A - 31A	8120-2104	8120-2956	8120-4211	8120-4753	8120-6800





L = Line or active conductor (also called "live" or "hot")

N = Neutral or identified conductor

E = Earth or safety ground

¹ For models E4360A and N6702A: Using 100-120 VAC limits total output power to 600 W. 200-240 VAC line is required to permit full 1200 W operation.

Choosing AC Line Voltage and Cord Options for your Agilent Power Products
DC Power Supplies, DC Electronic Loads, and AC Sources (Continued)

Cord Options	920	921	922	923	927
Product/Family					
	Argentina	Chile	China	South Africa	Thailand Phillipines
6033A, 38A	8120-6869	8120-6980	8120-8376	8121-0564	8120-8871
6060B, 63B	8120-6869	8120-6980	8120-8376	8121-0564	8120-8871
6541A - 45A	8120-6869	8120-6980	8120-8376	8121-0564	8120-8871
6551A - 55A	8120-6869	8120-6980	8120-8376	8121-1972	8120-8871
6611C - 14C	8120-6869	8120-6980	8120-8376	8121-0564	8120-8871
6621A - 6629A	8120-6869	8120-6980	8120-8376	8121-0564	8120-8871
6631B - 34B	8120-6869	8120-6980	8120-8376	8121-0564	8120-8871
6641A - 45A	8120-6869	8120-6980	8120-8376	8121-0564	8120-8871
6651A - 55A	8120-6869	8120-6980	8120-8376	8121-1972	8120-8871
6811B	8120-6869	8120-6980	8120-8376	8121-1972	8120-8871
66309B/D	8120-6869	8120-6980	8120-8376	8121-0564	8120-8871
66311B	8120-6869	8120-6980	8120-8376	8121-0564	8120-8871
66319B/D	8120-6869	8120-6980	8120-8376	8121-0564	8120-8871
66321B/D	8120-6869	8120-6980	8120-8376	8121-0564	8120-8871
66332A	8120-6869	8120-6980	8120-8376	8121-0564	8120-8871
E3620A	8120-6869	8121-0722	8120-8376	8121-0564	8120-0674
E3630A	8120-6869	8121-0722	8120-8376	8121-0564	8120-0674
E3631 - 34A	8120-6869	8121-0722	8120-8376	8121-0564	8120-0674
E3640 - 49A	8120-6869	8121-0722	8120-8376	8121-0564	8120-0674
E4360A	8120-6869	8121-2544	8120-8376	8121-1972	8120-8871
N5741A - 52A	N/A	N/A	8120-8376	N/A	N/A
N6700B, N6701A - 02A N6705B	8120-6869	8121-2544	8120-8376	8121-1972	8120-8871
N6950 - 54A N7950 - 54A	8120-6869	8121-0722	8120-8376	8121-1972	8120-8871
N6970 - 77A N7970 - 77A	8121-2366	8121-2374	8121-2378	8121-2367	8121-2358
N3300A - 31A	8120-6869	8120-6980	8120-8376	8121-0564	8120-8871

L = Line or active conductor (also called "live" or "hot")





N = Neutral or identified conductor

E = Earth or safety ground

For more detailed specifications see the product manual at www.agilent.com/find/power

Choosing AC Line Voltage and Cord Options for your Agilent Power Products

DC Power Supplies, DC Electronic Loads, and AC Sources (Continued)

Cord Options	929	930	931	932
Product/Family				
	Japan	Brazil	Taiwan	Cambodia
6033A, 38A		8121-1809	8121-1635	8121-1638
6060B, 63B		8121-1809	8121-1635	8121-1638
6541A - 45A		8121-1809	8121-1635	8121-1638
6551A - 55A		8120-8871	8120-5337	8120-8871
6611C - 14C		8121-1809	8121-1635	8121-1638
6621A - 6629A		8121-1809	8121-1635	8121-1638
6631B - 34B		8121-1809	8121-1635	8121-1638
6641A - 45A		8121-1809	8121-1635	8121-1638
6651A - 55A		8120-8871	8120-5337	8120-8871
6811B		8120-8871	8120-5337	8120-8871
66309B/D		8121-1809	8121-1635	8121-1638
66311B		8121-1809	8121-1635	8121-1638
66319B/D		8121-1809	8121-1635	8121-1638
66321B/D		8121-1809	8121-1635	8121-1638
66332A		8121-1809	8121-1635	8121-1638
E3620A		8121-1809	8121-1635	8121-1638
E3630A		8121-1809	8121-1635	8121-1638
E3631 - 34A		8121-1809	8121-1635	8121-1638
E3640 - 49A		8121-1809	8121-1635	8121-1638
E4360A	8121-2585	8120-8871	8120-5337	8120-8871
N5741A - 52A		N/A	N/A	N/A
N6700B, N6701A - 02A, N6705B	8121-2585	8120-8871	8120-5337	8120-8871
N6950 - 54A N7950 - 54A	8121-2585	8120-8871	8120-5337	8120-8871
N6970 - 77A N7970 - 77A	8121-2569	8121-2357	8121-2355	8121-2358
N3300A - 31A		8121-1809	8121-1635	8121-1638

L = Line or active conductor (also called "live" or "hot")
N = Neutral or identified conductor
E = Earth or safety ground

Choosing AC Line Voltage and Cord Options for your Agilent Power Products

DC Power Supplies, DC Electronic Loads, and AC Sources (Continued)

High power products

There are several factors which limit the amount of power which can be readily drawn from a normal branch circuit. For example, in the U.S., the typical 115/120 VAC branch circuit has a circuit breaker rated for 15 A. For industrial applications, 20 A service is commonly available.

Linear power supplies with outputs over 500 watts and switching supplies rated over 750 watts will generally exceed the capability of a 15 A branch circuit. Connecting power products above these power levels will require installing either a higher voltage or higher current service. Some practical examples are:

- standard line voltage for 2 kW products such as the 667XA is 230 VAC; they can not be powered off a 120 VAC line
- the 1KW 601XA and 603XA products cannot be powered off a standard 15 A/120 VAC circuit; they can operate off a 30 A/120 VAC service, or they can be configured for 208/240 VAC operation

Agilent offers a range of 800 series line cords for many higher power products to mate with the wall receptacles commonly specified for these higher power services. Refer to the tables to determine if there is a 800 series line cord for your product with a plug that meets the local requirements. If not, you must order an unterminated line cord.

Cord Options	831	832	833	834
Product/Family	No Plug #12AWG	No Plug 4 mm ²	No Plug 1.5 mm ²	No Plug #10AWG
6030A, 31A, 32A, 35A	8120-5573	N/A	8120-5568	8120-5566
6571A - 75A	8120-5488	8120-5490	N/A	8120-5545
6671A - 75A	8120-5488	8120-5490	N/A	8120-5545
6812B	8120-5573	N/A	8120-5568	8120-5566
6813B	8120-5573	8120-6502	N/A	8120-5566
66000A	8120-5573	N/A	8120-5568	8120-5566
E4356A	8120-5488	8120-5490	N/A	8120-5545
N6970 - 77A N7970 - 77A	N/A	N/A	N/A	8121-2568
N8731A-42A	8121-1949	8121-1331	N/A	N/A

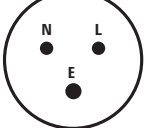
Cord Options	861	862	841	842
Product/Family	No Plug (AWG) N/S America, (AWG wire)	No Plug (Metric) Asia, Europe, Harmonized (metric wire)	 NEMA 6-20P #12AWG N/S America Japan	 IEC 309 32-A 4 mm ² Europe Korea
6030A, 31A, 32A, 35A	N/A	N/A	8120-5572	N/A
6571A - 75A	N/A	N/A	N/A	8120-5489
6671A - 75A	N/A	N/A	N/A	8120-5489
6680A - 84A	8121-6203	8120-6204	N/A	N/A
6690A - 92A	8121-0694	8121-0695	N/A	N/A
6812B	N/A	N/A	8120-5572	N/A
6813B	N/A	N/A	N/A	8120-6506
66000A	N/A	N/A	8120-5572	N/A
E4356A	N/A	N/A	N/A	8120-5489
N5761A-72A	8121-1330	8121-1331	N/A	N/A
N8731A-62A	8121-1946	8121-1948	N/A	N/A

Often, higher power products (over 1 kW) are hardwired, i.e. connected directly to a breaker panel or distribution box. The line cord may also be hard wired to the back of the power supply

where a universal receptacle is impractical. Typically, a local electrician should be consulted to determine the best alternative to connect a high power product to the AC line.

For more detailed specifications see the product manual at www.agilent.com/find/power

Choosing AC Line Voltage and Cord Options for your Agilent Power Products DC Power Supplies, DC Electronic Loads, and AC Sources (Continued)

Delta

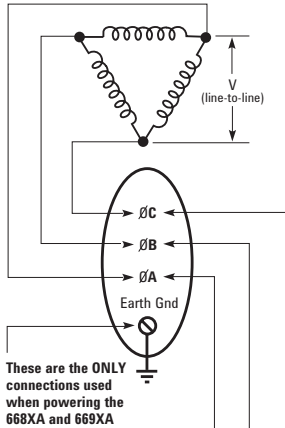

Wye

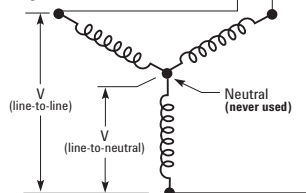

In a wye system

$$V_{(\text{line-to-neutral})} = \frac{V_{(\text{line-to-line})}}{\sqrt{3}}$$

Cord Options	844	845	846	847	848
Product/Family					
	NEMA L6-30P #10AWG N/S America Japan	IEC 309 16-A 1.5 mm² Denmark Switzerland Austria, China	NEMA L5-30P #10AWG N. America	CEE 7/7 16-A 1.5 mm² Europe Korea	BS 546 15-A 1.5 mm² India South Africa
6030A, 31A, 32A, 35A	N/A	8120-5570	8120-5565	8120-5567	8120-5569
6571A - 75A	8120-5546	N/A	N/A	N/A	N/A
6671A - 75A	8120-5546	N/A	N/A	N/A	N/A
6812B	N/A	8120-5570	8120-5565	8120-5567	8120-5569
6813B	8120-6507	N/A	N/A	N/A	N/A
66000A	N/A	8120-5570	8120-5565	8120-5567	8120-5569
E4356A	8120-5546	N/A	N/A	N/A	N/A

Note:

The countries or regions indicated here are for general guidance only. Local electrical codes governing wire size, wire type (AWG or metric) and plug type should be consulted to determine which of these available line cords/plugs is correct in your country to make proper connection to your AC mains. Please consult a qualified, licensed electrician for more information.

Products with 3-phase inputs

Some of the higher power products exceed the capability of a single phase line. Agilent offers several power products which require 3-phase inputs, including the 5 kW 668XA and 6.6 kW 669XA DC source family. For 3-phase power distribution up to the building, there are two different distribution systems in wide use: delta, predominantly used in the

US; and wye predominantly used in Europe. However, for service inside the building, the 5 wire wye is the predominant configuration. Products which are delta loads, are compatible with either delta or wye. Agilent 3-phase products are delta loads.

In selecting the correct operating voltage for 3-phase products you need to distinguish between the line-to-line and the line-to-neutral voltages. The line-to-line voltage is the square root of 3 x the line-to-neutral voltage. It is the line-to-line voltage that is used to specify the input voltage to be applied to Agilent power products.

Power Products

Applications Information

10 Most frequently asked questions about using DC power products
 AC Power and Load Connections
 Power Products Terms

10 Most frequently asked questions about using DC power products

1

How do I put the power supply in the constant current mode?

The power supply cannot be “put” into the constant current mode. The output settings of the power supply combined with the ohmic value of the particular load determine whether or not the power supply is in constant current.

ie: The power supply inherently resides in the constant voltage mode. If the output voltage were set to 24 volts and a 6 Ω load were placed across the output terminals, Ohm’s Law would require that 4 amps would flow (24 V/6 Ω). This presumes that the constant current setting of the power supply were set to a value greater than 4 amps; lets say 5 amps. Now, if the 6 Ω load were replaced by a 2 Ω load, Ohm’s Law would suggest that 12 amps (24 V/2 Ω) would flow. However, the power supply is set to go into constant current at 5 amps. Therefore, the actual output voltage would be 10 volts (2 Ω x 5 A). The power supply will now remain in constant current for values of load = 0 Ω ≤ R < 4.8 Ω. Once the ohmic value of the load becomes greater than 4.8 Ω (24 V/5 A), the power supply will again revert to constant voltage operation at the value of 24 volts.

2

I have 208 VAC, 3φ phase power; can it be used to operate a product requiring 208 V single phase?

Yes, see below.

657xA/667xA connection to a 3-phase line

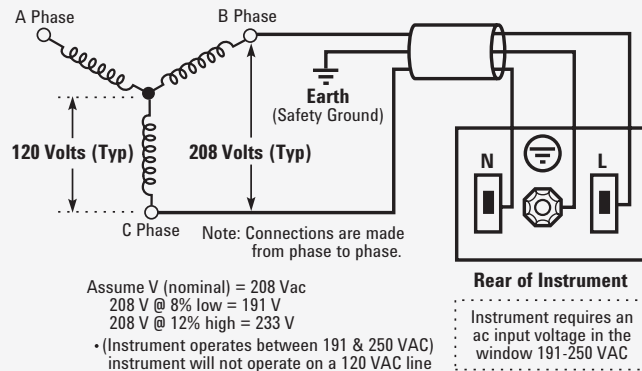

3

Why are the required Watts and VA so different?

Watts is a scalar quantity which is frequently used to measure system efficiency. It is the energy supplied by the utility company over a given period of time and is commonly referred to as power. Except for heavy industrial users, the utility company only bills users for the watts consumed. Watts are directly convertible into mechanical work or BTUs (British Thermal Units) of heat. Wasted power

is paid for a second time in terms of additional loading on the user’s air-conditioning system. Mathematically, it is a scalar quantity resulting from the vector product of two vector quantities (volts and amps). It is NOT the simple algebraic product of the rms volts times rms current.

VA on the other hand IS the scalar quantity resulting from multiplying the magnitudes (rms) of the vector

quantities (volts and amps). This resulting quantity will never be smaller than the watts demanded by an instrument. Uninformed users incorrectly use VA to assess the device's over-all efficiency and power demands. VA is most frequently and correctly used by electricians to determine proper AC mains conductor gage and circuit breaker sizing.

4
How much cooling do I need for my power supply?

Users frequently rack power supplies into an enclosure to supply power to some remotely located external load. Under these conditions, to properly determine the cooling requirements, the systems integrator needs thermal data from the manufacturer for the specific enclosure in question. This data is generally in the form of a curve which relates the rise of the enclosure's internal air temperature to the amount of power (or BTU's) dissipated within the enclosure.

The difference between the maximum power demanded by the external load, and the AC power demanded by the power supply to support the load's needs, is the power dumped into the internal air of the enclosure. Using this number and data for the enclosure, the internal rise can be determined. The internal rise added to the external ambient temperature will determine the temperature of the environment for the power supply. This must be within the ratings of the product or premature failure will occur.

A valuable conversion factor between Watts and BTU's is listed below:

$$1 \text{ BTU/Hr} = 0.293 \text{ Watt}$$

The N57xxA family draws cooling air from the outside of the rack. Thus, the air temperature is equal to that of the room's environment. Heated, cooling air is then exhausted into the inside of the rack. As a result, these instruments will not properly cool if the inside of the rack is "pressurized". The static air pressure within the rack must be equal to or less than the air pressure in the room's ambient.

5
Can Agilent power supplies sink current?

Yes! Sinking, or downprogramming, is the ability of a power supply to pull current into the positive power terminal. Sinking is necessary to discharge the power supply's own output capacitor, or the capacitors that are part of an external load.

Sinking is particularly important, for example, in printed circuit board test systems. The relays in test board systems typically must be switched only when the power supplies have discharged to zero volts, to avoid arcing and burn-out of the relay contacts. Sinking allows the power supply outputs to go to zero quickly, thus providing faster test times, an important factor for reducing overall test cost.

The value of the sink current is fixed and is not programmable, with the exception of the 6630 series, where sink current is set to the same value that is programmed for source current.

In general, sinking is provided to improve a power supply's transition time from a higher to a lower constant voltage operating level, and is not intended to be a steady-state operating condition.

Other models not listed here do not have high powered down programmers. Instead, they are capable of discharging the power supply output capacitors but not sinking current from the device under test.

Series	Current Sinking Capability
6620 Multiple Output	110% of source current rating
6630 100 Watt	110% of source current rating
6030 Autorangers	50 W/actual output voltage in volts or actual voltage in volts/0.05 ohms, whichever is less
6640 200 Watt	25% of source current rating
6650 500 Watt	20% of source current rating
6750/6760 50/100 Watt	Dynamically controlled to maximize output down-programming speed. 7 W continuous dissipation, 300 W peak.

Series	Current Sinking Capability
6670 2000 Watt	50 W/actual output voltage in volts or actual output voltage in volts/0.05 ohms, whichever is less
6680 5000 Watt	50 W/actual output voltage in volts or actual output voltage in volts/0.05 ohms, whichever is less
6690 6600 Watt	50 W/actual output voltage in volts or actual output voltage in volts/0.05 ohms, whichever is less

6

I want to put a microswitch on the safety cover over my UUT so that lifting the cover will program my ATE power supplies to zero volts and protect the operator from harm. Do Agilent power supplies have this capability?

Yes, many Agilent power supplies have a feature called “Remote Inhibit” (RI).

When connected to the RI input on the rear of the power supply, a contact closure or TTL low signal causes the output of the supply to shutdown and be programmed to zero volts. The power supply can also be set to generate a service request (SRQ) via the GPIB in the event that RI is pulled low.

7

Can I use Agilent electronic loads in series and in parallel?

Agilent electronic loads are designed to be operated in parallel for more current, but NOT in series for more voltage. Loads are fully protected

against damage from current overloads, but will be damaged by voltage above the maximum voltage rating.

8

I must test a 1 volt power supply using a constant current load and I want to use Agilent electronic loads. But the Agilent load meets all of its dynamic specs with

no derating on down to 3 volts. Below 2 volts, the Agilent load current must be linearly derated. What can I do?

Use a boost supply in series with the UUT. The load will now meet all its specs with no derating, because it always operates above 3 volts. (see the illustration below)

The voltage setting of a programmable boost supply should be set to 3 volts, and the current limit set to full scale.

The boost supply can be a low-cost fixed output 3 V or 5 V supply with a current rating at least as high as the maximum peak load current needed. The 6641A (8 V, 20 A), 6651A (8 V, 50 A), 6671A (8 V, 220 A), or 6681A (8 V, 580 A) are all excellent choices.

Select a boost power supply with low p-p ripple and noise. The constant current load will compensate for low-frequency p-p ripple and noise below a few kHz, but high frequency ripple and noise from the boost will appear across the UUT.

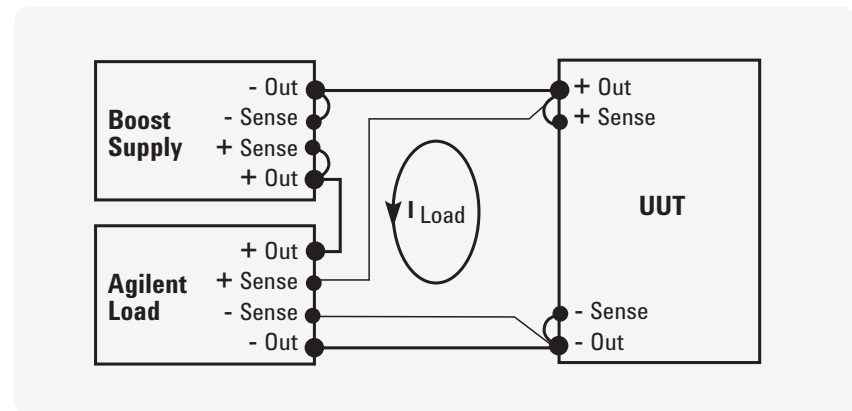

9

Why are Agilent's electronic loads constant resistance resolution specified in ohms on the low resistance range, but in mSiemens on the two higher ranges?

In general, Agilent's electronic loads are not a conventional "resistor". The loads consist of IC's, capacitors, resistors, FETs, etc. They were designed with two major circuits, a CV and CC circuit. These circuits are used to simulate resistance on the two upper ranges.

First, it is necessary to understand why there is a difference in the way in which the ranges are specified (mohms or ms). The constant resistance (CR) mode in the load actually operates using either the constant current (CC) or constant voltage (CV) circuits inside the load. The lowest CR range uses the CV regulating circuits, while the two higher ranges use the CC regulating circuits. It is because of these differences in the circuits used to regulate the load input that the specifications need to be different.

When the CV circuits are used, the load can be viewed as many resistors, all the same value (the resolution), in series to produce the desired resistance. Then, changing the resistance is like changing the number of discrete resistors in

series. Therefore, the resolution is the value of one of these series resistors, and putting resistors in series changes the resistance measured in ohms. For the N3302A, the "discrete resistor" or resolution that can be programmed is 0.54 mohms in the 2 ohm range.

When the CC circuits are used, the load can be viewed as many resistors, all the same value (the resolution), in parallel to produce the desired resistance. Then, changing the resistance is like changing the number of discrete resistors in parallel. Therefore, the resolution is the value of one of these parallel resistors, and putting resistors in parallel changes the conductance measured in siemens. For the 60501B, the "discrete resistor" or resolution that can be programmed is 0.14 ms (=7.14 kohms).

For example, in the 2 kohm range, you can program the load input from 2 ohms to 2 kohms (0.5 s to 0.5 ms) with a resolution of 0.14 ms. This would be the equivalent of starting with about 3568 7.143 kohm resistors in parallel with each other, and in parallel with a 2 kohm resistor, and removing one at a time until you had only the 2 kohm resistor left.

Note that the resolution of the conductance is constant at 0.14 ms, however, the resolution of the total parallel resistance is not constant. It depends on how many resistors you have in parallel.

If you have two 7.143 kohm resistors in parallel and remove one, the resolution looks like 3571.5 ohms. If you have 3568 7.143 kohm resistors in parallel and remove one, the resolution looks like $(7143/3567) - (7143/3568) = 0.561$ mohms. But the conductance resolution is constant at 0.14 ms.

10

Can Agilent power supplies be programmed from 0 to full output voltage using a 0 to 10 V signal source?

Yes, many Agilent power supplies feature remote voltage programming or analog programming capability. However, there is a potential danger in analog programming any power supply, especially a high voltage supply. If the 0 to 10 V programming source is a typical, non-isolated, low-cost, digital-to-analog converter (DAC), it is probably grounded through its digital inputs and/or through the computer's internal power supplies, which are grounded through the computer's power cord. It's easy to overlook this, and the mistake can be very expensive.

If the DAC is non-isolated (or isolated only up to 42 V above ground) and one of the output terminals of the power supply is grounded, either directly or through the UUT, the output capacitor of the power supply can discharge through the computer backplane, motherboard, and the I/O common through the computer power cord ground. The resulting high current may even last long enough to vaporize the thin ground tracks on some or all of the printed circuit boards in the PC.

Be sure the programming source is electrically isolated, is operated from isolated power supplies, and is rated for floating voltages up to the full output voltage of the programmed supply. This is necessary so no one is hurt, and no equipment is damaged, no matter which output terminal of the power supply or UUT is grounded.

For additional questions and answers visit our web site at www.agilent.com/find/answers

A modern stabilized DC power supply is a versatile high performance instrument capable of delivering a constant or controlled output reliably and with little attention. But to take full advantage of the performance characteristics designed into a supply, certain basic precautions must be observed when connecting it for use on the lab bench or installing it in a system. Factors such as wire ratings, system grounding techniques, and the particular way that AC input, DC output, and remote error sensing connections are made can contribute materially to obtaining the stable, low noise output expected by the user. Careful attention to the following guidelines can help to ensure the trouble free operation of your Agilent power supply.

AC Power Input Connections

Wire Rating

RULE 1. When connecting AC power to a power supply, always use a wire size rated to carry at least the maximum power supply input current.

If a long cable is involved, make an additional check to determine whether a still larger wire size might be required to retain a sufficiently low impedance from the service outlet to the power supply input terminals. As a general guideline, input cables should be of sufficient size to ensure that the voltage drop at maximum rated power supply input current will not exceed 1% of the nominal line voltage.

Continuity

RULE 2. Maintain the continuity of the AC, acc, and grounding wires from the AC power outlet to the power supply input terminals without an accidental interchange.

Interchanging the AC and grounding wires may result in the power supply chassis being elevated to an AC potential equal to the input line voltage. If the chassis is grounded elsewhere, the result may be no worse than some blown fuses. But if the chassis is not grounded, the result could be a potentially lethal shock hazard. Confirm that the chassis is grounded by the grounding wire.

Transformers

RULE 3. If an autotransformer or an isolation transformer is connected between the AC power source and the power supply input terminals, it should be rated for at least 200% of the maximum rms current required by the power supply.

The transformer must have a higher rating than would be suggested by the supply's rms input current because a power supply input circuit does not draw current continuously. Input current peaks can cause a smaller transformer to saturate, resulting in failure of the supply to meet its specifications at full output.

RULE 4. Be sure to connect the common terminal of an autotransformer to the acc (and not the AC) terminals of both the power supply and the input power line.

If acc is not connected to the common terminal of the autotransformer, the power supply's input acc terminal will have a higher than normal AC voltage connected to it, contributing to a shock hazard and, in some instances, a greater output ripple.

AC Line Regulator

RULE 5. Do not use an AC line regulator at the input to a regulated power supply without first checking with the power supply manufacturer.

Some regulators tend to increase the impedance of the line in a resonant fashion and can cause power supplies to malfunction, particularly if they use SCR or switching regulators or preregulators. Moreover, since the control action of many line voltage regulators is accompanied by a change in the output waveshape, their advantage in providing a constant rms input to a power supply is small. In fact these changes in waveshape are often just as disruptive in causing power supply output changes as the original line voltage amplitude changes would have been.

Load and Remote Error Sensing Connections

Making Load Connections to One Power Supply

The simplest and most common example of improper load wiring is shown in Figure 1. The voltage at each load depends on the current drawn by the other loads and the voltage drops they cause in some portion of the load leads. Since most load currents vary with time, an interaction among the loads results. This interaction can sometimes be ignored, but in most applications the resulting noise, pulse coupling, or tendency toward inter-load oscillation is unacceptable. The following thirteen steps describe a recommended procedure for connecting the load wiring, grounding the system in a manner that avoids troublesome ground loops, and making connections for remote error sensing.

STEP 1. Select a load wire size that, as an absolute minimum, is heavy enough to carry the power supply output current that would flow if the load terminals were short-circuited.

This is the minimum, however. Impedance and coupling considerations usually dictate the use of load wires larger than would be required just to satisfy current rating requirements. In general, the power supply performance degradation seen at the load terminals becomes significant when the wire size and length result in a load wire impedance comparable to or greater than the effective output impedance of the power supply. Refer to a copper wire resistance table to see if a larger wire size might have to be used to attain an impedance comparable to or smaller than the output impedance of the power supply.

If multiple loads are supplied from a pair of DC distribution terminals not located at the power supply terminals, it is necessary to consider separately the mutual impedance of the wires connecting the power supply to the distribution terminals and the additional impedance of the wires to each individual load. The mutual impedance presents an opportunity for a variation of one load current to cause a DC voltage variation at another load. Fortunately this mutual impedance can be effectively reduced at DC and at low frequencies by using remote error sensing, as will be described later.

Connect the Load Wiring

STEP 2. Designate a single pair of terminals as the positive and negative DC distribution terminals.

These two terminals might be the power supply output terminals, the load terminals, or a separate pair of terminals established expressly for distribution. If the power supply is a short distance from the load and remote sensing will not be used, locate the DC distribution terminals as near as possible to the power supply output terminals. Using the power supply output terminals themselves as the distribution terminals results in optimum performance.

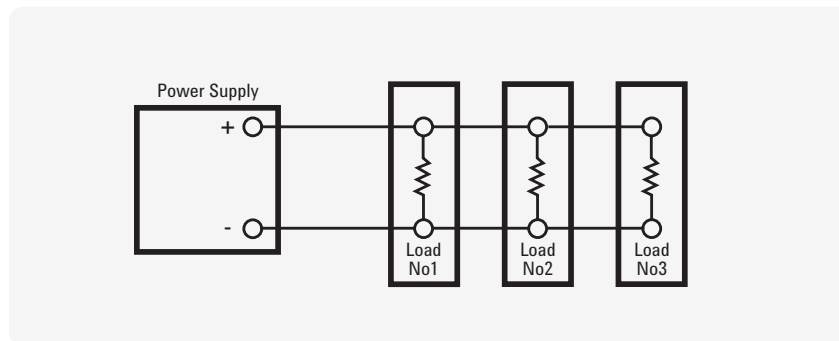

Figure 1
Improper load connections

If remote sensing is to be used, locate the DC distribution terminals as near as possible to the load terminals. Later in the procedure, sensing leads will be connected from the power supply sensing terminals to the DC distribution terminals as shown in Figure 2.

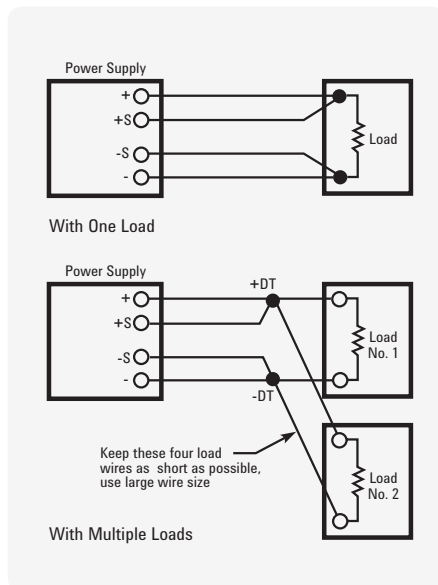

Figure 2
Location of DC distribution terminals with remote sensing (distribution terminals are shown solid)

STEP 3. Connect one pair of wires directly from the power supply output terminals to the DC distribution terminals, and connect a separate pair of wires from the distribution terminals to each load.

There should be no direct connection from one load to another except by way of the DC distribution terminals. (Although for clarity the diagrams show the load and sensing leads as straight lines, some immunity against pick-up from stray magnetic fields can be obtained by twisting each pair of load leads and shielding all sensing leads.)

Decouple Multiple Loads

STEP 4. If required, connect a local decoupling capacitor across each pair of distribution and load terminals.

Load decoupling capacitors are often needed when multiple loads draw pulse currents with short rise times. To reduce high frequency mutual coupling effects under these circumstances, capacitors must be connected directly across the load and distribution terminals. The capacitors used for decoupling must be selected to have a high frequency impedance that is lower than the impedance of the wires connected to the same load, and their connecting leads must be kept as short as possible to minimize impedance.

Grounding the System

Since no two ground points have exactly the same potential, the idealized concept of a single ground potential is a snare and a delusion. In many cases the potential difference is small, but a difference in two ground potentials of even a fraction of a volt could cause amperes of current to flow through a complete ground loop. (Ground loop is a term used to describe any conducting path formed by two separate connections to ground). Ground loops can cause serious interference problems when voltages developed by these currents are coupled into sensitive signal circuits.

To avoid ground loop problems, there must be only one ground return point in a power supply system. (A power supply system includes the power supply, all of its loads, and all other power supplies connected to the same loads). The selection of the best ground return point depends on the nature and complexity of the DC wiring. In large systems, practical problems frequently tend to force compromises with the ideal grounding concept. For example, a rack mounted system consisting of separately mounted power supplies and loads generally has multiple ground connections. Each instrument usually has its own chassis tied to the third grounding wire of its power cord, and the rack is often connected by a separate wire

to ground. With the instrument panels fastened to the rack frame, circulating ground currents are inevitable. However, as long as these ground currents are confined to the ground system and do not flow through any portion of the power supply DC distribution wiring, their effect on system performance is usually negligible. To repeat, separating the DC distribution circuits from any conductive paths in common with ground currents

will in general reduce or eliminate ground loop problems. The only way to avoid such common paths is to connect the DC distribution system to ground with only one wire. Figure 3 illustrates this concept: DC and signal currents circulate within the DC system, while ground loop currents circulate within the ground system. Steps, 5, 6, and 7 make specific recommendations for avoiding ground loop problems.

Select the DC Common Point

STEP 5. Designate one of the DC distribution terminals as the DC common point.

There should be only one DC common point in a DC system. If the supply is to be used as a positive source, then the negative DC distribution terminal is the DC common point. If it is to be a negative source, then the positive DC distribution terminal is the DC common point. Here are some additional suggestions for selecting the best DC common point for five different classes of loads:

a. Single isolated load.

A single isolated load exists when a power supply is connected to only one load and the load circuit has no internal connections to the chassis or ground. If the power supply output terminals are to be used as the DC distribution terminals, then the DC common point will be either the positive or negative power supply output terminal (Figure 4A). If remote sensing is to be used and the load terminals will serve as the distribution terminals, then either the positive or negative load terminal will be the DC common point (Figure 4B).

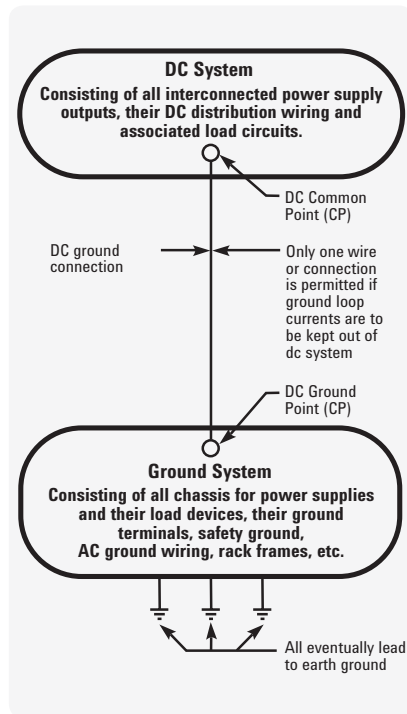

Figure 3
Isolating ground loop paths from the DC system

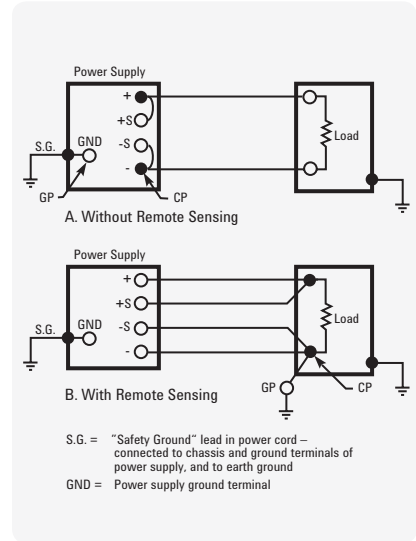

Figure 4
Preferred ground connections for a single isolated load

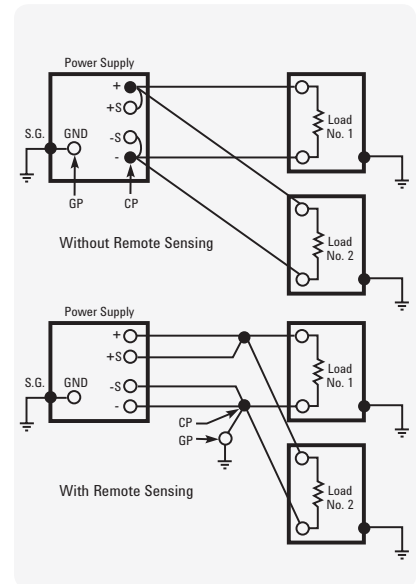

Figure 5
Preferred ground connections for multiple ungrounded loads

b. Multiple ungrounded loads.

This alternative applies when separate pairs of load leads connect two or more loads and none of the load circuits has an internal connection to chassis or ground (Figure 5). Use the positive or negative DC distribution terminal as the DC common point.

c. Single grounded load.

When a power supply is connected to a single load that has a necessary internal connection to chassis or ground as in Figure 6, or when a supply is connected to multiple loads only one of which has a necessary internal connection to chassis or ground as in Figure 7, the load terminals of the grounded load must be designated the DC distribution terminals, and the grounded load terminal is necessarily the DC common point.

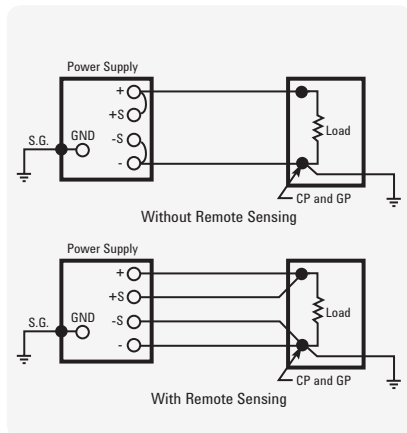

Figure 6
Preferred ground connections for a single grounded load

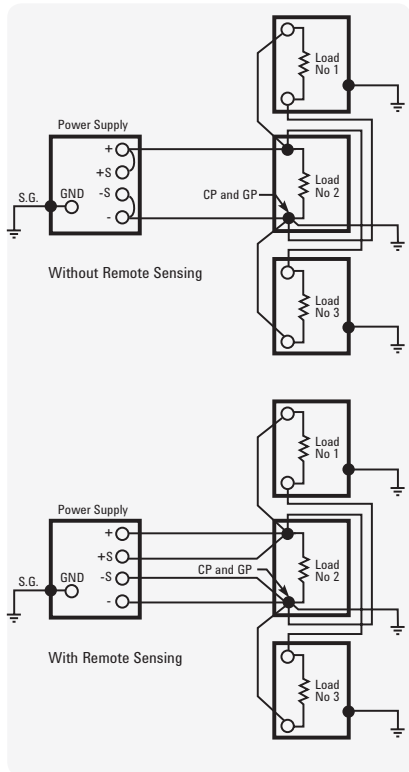

Figure 7
Preferred ground connections for multiple loads, only one of which is grounded internally

d. Multiple Loads, Two or More of Which are Individually Grounded.

This undesirable situation must be eliminated if at all possible. Ground loop currents circulating through the DC and load wiring cannot be avoided so long as separate loads connected to the same power supply or DC system have separate ground returns as shown in Figure 8.

One possible solution is to break the ground connection in all of the loads and then select the DC common point using the multiple ungrounded load alternative as in (b) above. Another would be to break the ground connection in all but one of the loads and select the DC common point as in alternative (c). If there are two or more loads with ground connections that cannot be removed and the system is susceptible to ground loop problems, then the only satisfactory solution is to increase the number of power supplies and to operate each grounded load from a separate supply. Each combination of power supply and grounded load would be treated as in alternative (c).

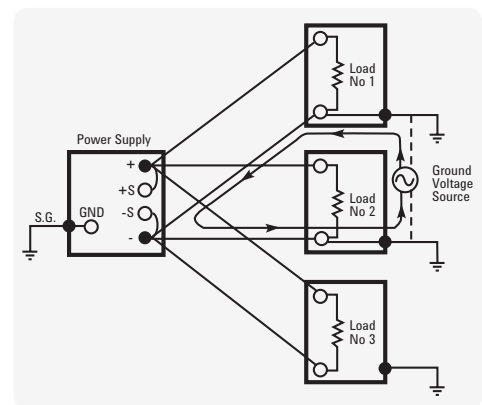

Figure 8
Improperly connected DC distribution system with two grounded loads forming a ground loop

e. Load system floated at a DC potential above ground.

It is sometimes necessary to operate the power supply output at a fixed voltage above or below ground potential. The usual procedure in these circumstances is to designate a DC common point using whichever of the preceding four alternatives is appropriate, just as though conductive grounding were to be used. Then connect this DC common point to the DC ground point through a 1 microfarad capacitor as shown in Figure 9.

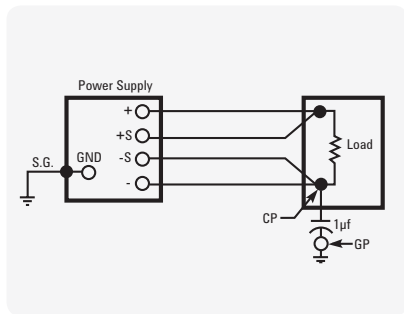

Figure 9
Floating a load system at a DC potential above ground

Select the DC Ground Point

STEP 6. Designate the terminal that is connected to ground as the DC ground point.

The DC ground point can be any single terminal, existing or added, that is conductively connected to the ground of the building wiring system and then eventually to earth ground.

STEP 7. Connect the DC common point to the DC ground point, making certain there is only one conductive path between these two points.

Make this connection as shown in Figures 4, 5, 6, or 7. Make the connection as short as possible and use a wire size such that the total impedance from the DC common point to the DC ground point is not large compared with the impedance from the ground point to earth ground. Flat braided leads are sometimes used to further reduce the high frequency component of the ground lead impedance.

Making Remote Error Sensing Connections

Normally a power supply operating in the constant voltage mode achieves its optimum line and load regulation, its lowest output impedance, drift, and PARD, and its fastest transient recovery performance at the power supply output terminals. If the load is separated from the output terminals by any lead length (as in Figure 10), some of these performance characteristics will be degraded at the load terminals—usually by an amount proportional to the impedance of the load leads compared with the output impedance of the power supply.

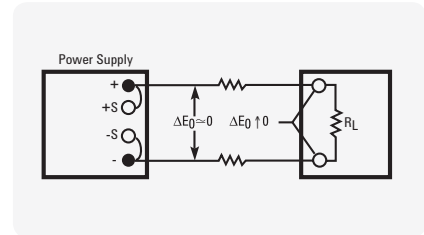

Figure 10
Load voltage variations caused by load lead voltage drops when remote error sensing is not used

With remote error sensing, a feature included in nearly all Agilent power supplies, it is possible to connect the input of the voltage feedback amplifier directly to the load terminals so that the regulator performs its function with respect to the load terminals rather than with respect to the power supply output terminals. Thus, the voltage at the power supply output terminals shifts by whatever amount is necessary to compensate for the voltage drop in the load leads, thereby maintaining the voltage at the load terminals constant (Figure 11).

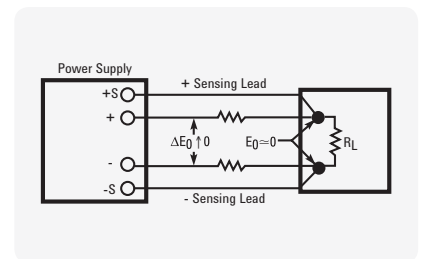

Figure 11
Regulated power supply with remote error sensing

Making the Sensing Connections

STEP 8. Remove the jumper connections between the power supply sensing and output terminals, and connect the power supply sensing terminals to the DC distribution terminals as shown in Figure 12.

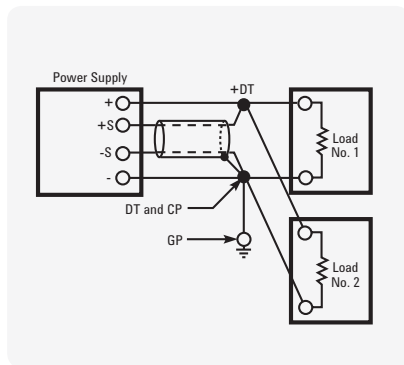

Figure 12
Properly grounded power supply system with remote error sensing

Use an insulated shielded pair for the sensing leads. Do not use the shield as one of the sensing conductors.

STEP 9. Connect one end of the sensing lead shield to the DC common point and leave the other end unconnected.

In nearly all cases this method of connecting the sensing shield minimizes ripple at the DC distribution terminals.

Protect Against Open Sensing Leads Step

STEP 10. Avoid the possibility of an open remote sensing path, either on a long-term or a transient basis.

Opening a sensing lead causes the power supply output voltage to increase. Protective circuits in the supply provide some load protection by limiting the amount of the increase, but eliminating all switch, relay, or connector contacts from the remote sensing path helps to minimize the possibility of any loss of regulation due to this cause.

Check the Load Wire Rating

STEP 11. Verify that the voltage drop in the load leads does not exceed the capabilities of the remote sensing circuit.

Most well regulated power supplies have an upper limit to the load lead voltage drop around which remote sensing can be connected without losing regulation. This maximum voltage drop is typically 0.5, 1, or 2 volts, and may apply to the positive, the negative, or both the positive and negative output leads. See the instruction manual for the exact load lead voltage drop limitations of a particular power supply.

Remember too, that any voltage drop lost in the load leads reduces the maximum voltage available for use at the load. Either of these limitations sometimes dictates the use of a larger wire size than would be required by wire current rating or impedance considerations.

Check for Power Supply Oscillation

STEP 12. Verify that the power supply does not oscillate when remote sensing is connected.

Although DC and low frequency performance are improved by remote sensing, phase shifts associated with long load and sensing leads can affect the stability of the feedback loop seriously enough to cause oscillation. This problem can frequently be corrected by readjusting a “transient recovery” or “loop stability” control inside the supply if the circuit includes one; follow the adjustment procedure in the manual. Another remedy that is often effective is to disconnect the output capacitor inside the power supply (some models have a rear panel jumper that can be removed for this purpose) and to connect a similar capacitor across the DC distribution terminals.

Check for Proper Current Limit Operation

STEP 13. Check that the operating point of the current limit circuit has not been affected by the remote sensing connections.

With some power supply designs, the resistance of one of the output conductors adds to the resistance used for current limit monitoring when remote sensing is used. This reduces the threshold value at which current limiting begins and makes readjustment of the current limit

circuit necessary. To determine whether connecting remote sensing has changed the current limit setting, turn off the supply, short terminal -S to -OUT and +S to +OUT at the power supply, and check whether the current limit value differs from the value without these terminals shorted. If it does differ significantly, the current limit control needs readjustment.

Making Load Connections to Two or More Power Supplies in the Same System

The following four rules must also be observed in extending the preceding techniques to systems containing two or more power supplies.

DC Distribution Terminals

RULE 1. There must be only one point of connection between the DC outputs of any two power supplies in the multiple power supply system. This point must be designated as one of the two DC distribution terminals for those two power supplies.

Thus there are always exactly (N+1) DC distribution terminals in any system, where N is the number of power supplies. (This is true unless parallel supplies share the same distribution terminals, or supplies are connected in series with no other connections to their intermediate terminals).

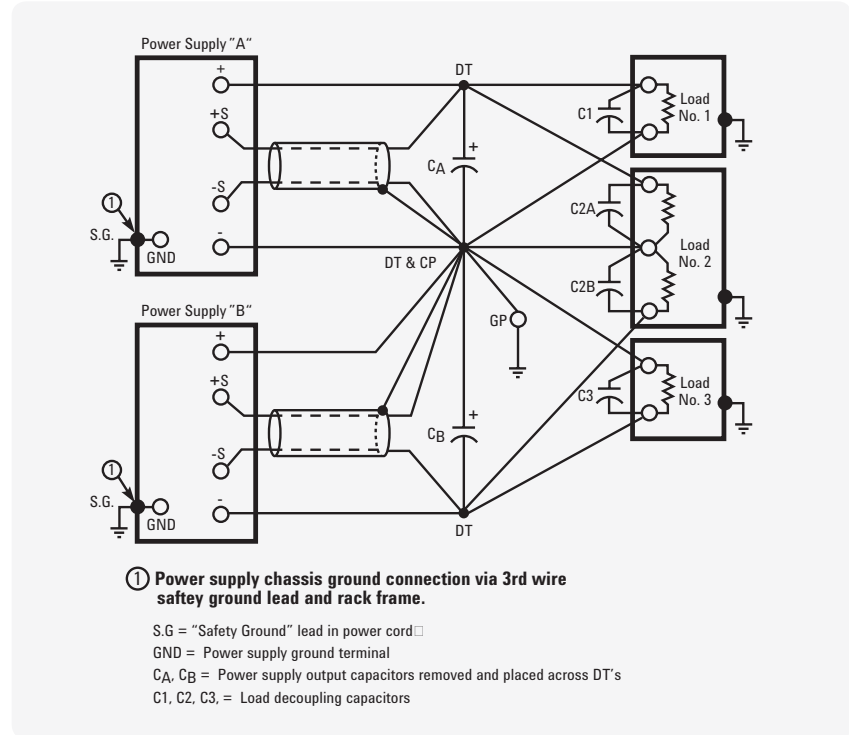

Figure 13
A properly connected multiple power supply system

DC Common Point

RULE 2. One of the (N+1) DC distribution terminals must be designated as the DC common point for the system.

There can be only one DC common point allowed in a system.

DC Ground Point

RULE 3. There must be only one DC ground point in a multiple power supply system.

This rules out the possibility of connecting two grounded loads in the same system.

RULE 4. There must be only one conductive path between the system DC common point and the system DC ground point.

This rule is repeated from Step 7 above as a reminder because of the far greater number of possible paths to ground in a multiple power supply system. Figure 13 shows an example of a properly connected and grounded multiple power supply system.

AC input current: the maximum current into the power supply or electronic load. The current specified is worst case (low line voltage, full output).

Actual transition time: for an electronic load, either the total slew time (voltage or current change divided by slew rate - time) or the minimum transition time, whichever is longer.

Auto-parallel operation: a master-slave connection of the outputs of two or more supplies or the inputs of two or more electronic loads used for obtaining a current rating greater than can be obtained from a single load or supply. Only supplies that have the same voltage and current ratings should be paralleled.

Auto-series operation: a master-slave connection of the outputs of two or more supplies used for obtaining a voltage greater than can be obtained from one supply. Only supplies that have the same voltage and current ratings should be connected in series.

Auto-tracking operation: a master-slave connection of two or more supplies each of which has one of its output terminals in common with one of the output terminals of all of the other supplies.

Command processing time: the average time required for a power supply output voltage, or electronic load input voltage or current, to begin to change following receipt of a voltage or current set command over GPIB. This is effectively the time it takes for the power supply or electronic load to interpret the voltage set command and initiate a response.

Common mode noise: the current flowing from either output terminal (+ and -) through the power supply to chassis ground.

Compliance voltage: the output voltage of a power supply operating in the constant-current mode.

Constant-current (CC) mode: a power supply that stabilizes output current with respect to changes in load impedance. Thus, for a change in load resistance, the output current remains constant while the output voltage changes by whatever amount necessary to accomplish this.

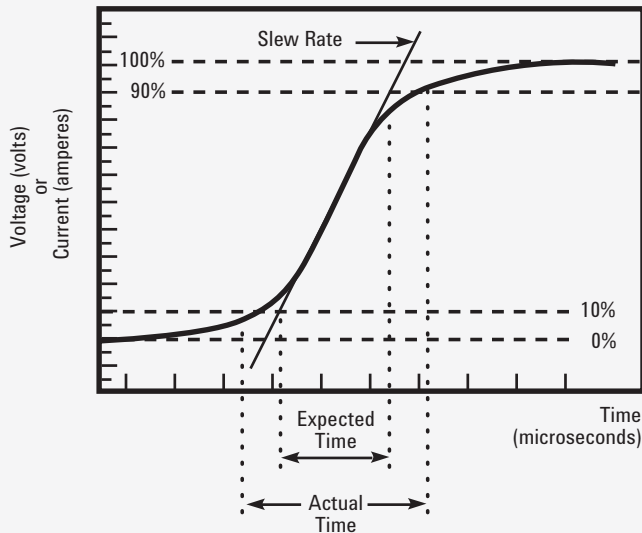

Risetime transition limitation

Ambient temperature: the temperature of the air immediately surrounding the power supply or electronic load.

Analog programming: controlling the output voltage and/or current with an analog signal. This signal could be a voltage, current or resistance. This is similar to using the power supply as an amplifier.

Auto-ranging power supply: a power supply that can provide maximum rated power over a wide and continuous range of voltage and current settings.

Constant-current/voltage/resistance mode electronic load: an electronic load that can operate in one of the following ways:

CC= ratio of voltage to current in accordance with the programmed value regardless of the input voltage

CV= ratio of voltage to current in accordance with the programmed value regardless of the input current

CR= ratio of voltage to current while maintaining the programmed resistance value

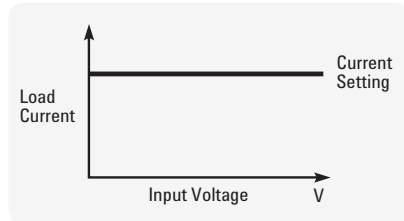

Constant-current mode

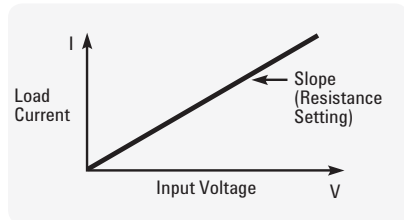

Constant-resistance mode

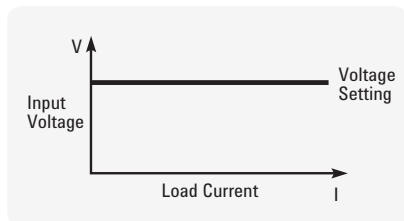

Constant-voltage mode

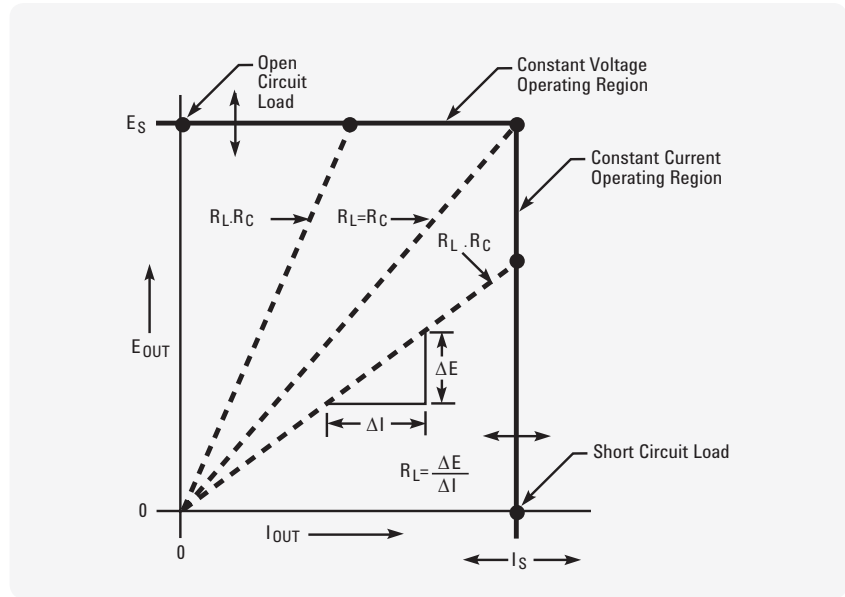

Constant-voltage/constant-current output characteristics

Constant-current/voltage/resistance regulation: the change in the steady-state value of the stabilized electronic load input voltage, current, or resistance resulting from a full scale source change, with all other influence quantities held constant.

Constant-voltage (CV) mode: a power supply that stabilizes output voltage with respect to changes in influence quantities. Thus, for a change in load resistance, the output voltage remains constant while the output current changes by whatever amount necessary to accomplish this.

Constant-voltage/constant current (CV/CC) power supply: a power supply that operates as a constant-voltage power supply or a constant-current power supply, depending on load conditions. The supply acts as a constant-voltage source for comparatively large values of load resistance and as a constant-current source for comparatively small values of load resistance.

Constant-voltage/current limiting

(CV/CL) power supply: a power supply similar to a constant-voltage/constant-current supply except that at comparatively small values of load resistance, its output current is limited instead of being stabilized.

Crest factor: the ratio of the zero-to-peak value to the rms value of a waveform. This term is often used to specify the maximum peak amplitude that an AC power supply can source (relative to its maximum rms rating) without distortion.

Crowbar: see overvoltage protection.

Current limiting: the action, under overload or short-circuit conditions, of limiting the output current of a constant-voltage supply to some predetermined maximum value (fixed or adjustable) and automatically restoring the output voltage to its normal value when the overload or short circuit is removed. There are three types of current limiting:

- by constant-voltage/constant-current crossover
- by decreasing the output voltage as the current increases
- by decreasing both voltage and current as the load resistance decreases.

DFI: a TTL compatible output signal that can be used as an alarm and automatically initiates an action for multiple power supply or electronic load shutdown. The DFI signal is commonly connected to RI of the next supply. (See RI)

Downprogramming: the ability of a power supply to discharge its output capacitors independently of load. The use of an active down programming device can reduce the fall time of the output voltage.

Drift: the maximum change of a power supply output or load input voltage or current during an 8-hour period following a 30-minute warmup, with all influence and control quantities maintained constant during the warm-up time and the period of drift measurement. Drift includes both periodic and random deviations over the bandwidth from zero frequency (DC) to a specified upper frequency limit.

Efficiency: expressed in percent, efficiency is the total output power of the supply divided by the active input power. Unless otherwise specified, Agilent measures efficiency at maximum rated output power and at worst case conditions of the AC line voltage.

Electromagnetic interference (EMI): any type of electromagnetic energy that could degrade the performance of electrical equipment. The EMI generated by a power supply can be propagated either by conduction (via the input and output leads) or by radiation from the units' case. The terms "noise" and "radio-frequency interference" (RFI) are sometimes used in the same context.

Electronic load: an active device which absorbs power. Loads are used for the testing of the power producing products.

Foldback: immediate shutdown of the power supply output when a crossover between constant voltage and constant current mode occurs. Both the voltage and current levels are reduced (folded back).

Harmonics: the occurrence of this type of distortion is based upon the mathematical principle that all periodic waveforms are made up of a series of sine waves. As a result, harmonic distortion is produced at frequencies that are integer multiples of the fundamental or desired signal frequency. When viewed in the frequency domain, harmonics have an amplitude (often expressed in db), frequency, and phase characteristic relative to the fundamental.

Isolation: the maximum voltage (including output voltage) either output terminal may be floated from earth ground.

Load cross regulation: the affect on one output of a multiple output power supply when another output is programmed from zero to full rated current.

Load effect: also known as “load regulation”. Load effect is the change in the steady-state value of the stabilized output voltage or current resulting from a full-load change in the load current of a constant-voltage supply or the load voltage of a constant-current supply, with all other influence quantities maintained constant.

Load effect transient recovery time: the time interval between a specified step change in the load current of a constant-voltage supply (usually a full-load or 5-amp change, whichever is smaller) or in the load voltage of a constant-current supply and the instant when the stabilized output quantity returns to and stays within a specified transient recovery band.

Master-slave operation: a method of interconnecting two or more supplies or electronic loads such that one of them (the master) serves to control the others (the slaves). The outputs of the slave supplies or inputs of the slave electronic loads always remain equal to or proportional to the output of the master. The outputs of the master supply and of one or more slaves may be connected in series, in parallel, or with just their negative or positive output terminals in common. (See also “complementary tracking”). The inputs of the master electronic load and one or more slaves may be connected in parallel only.

Minimum transition time: the shortest possible time in which an electronic load input can change from one level to another. This is determined by the small signal bandwidth of the load.

Modulation: analog programming of the output voltage and/or current. The output programming response time determines the maximum slew rate at which the power supplies output can be programmed.

Nominal value: the value that exists “in name only”; not the actual value. For example, in the case of a power supply with a calibrated output control, the nominal value is the value indicated by the control setting. For a supply with a fixed output, the nominal output is the output indicated on the nameplate. The nominal value of a 120-volt $\pm 10\%$ line voltage is 120 volts.

“One-box”: a power supply that can be controlled by direct connection to a computer (with no additional programmers) and that can provide measured data to a computer without external voltmeters or ammeters.

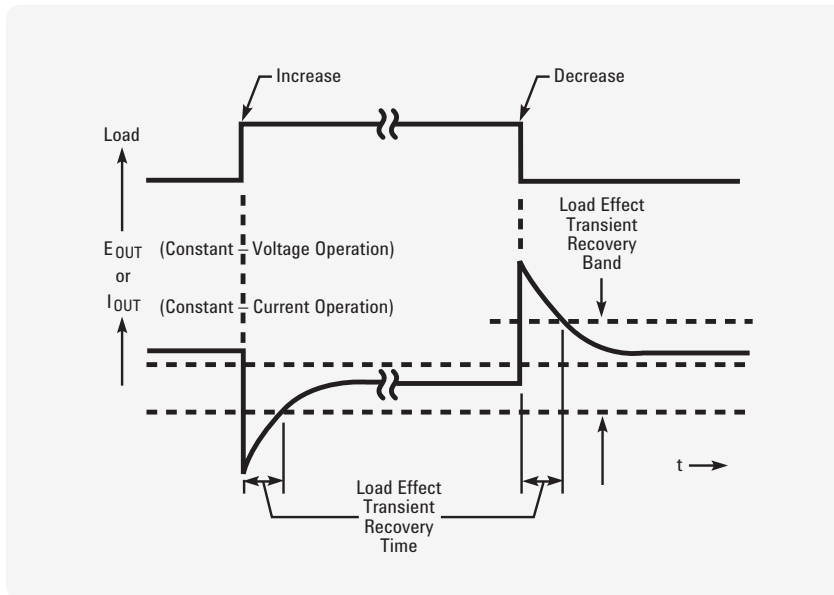

Load effect transient recovery waveforms

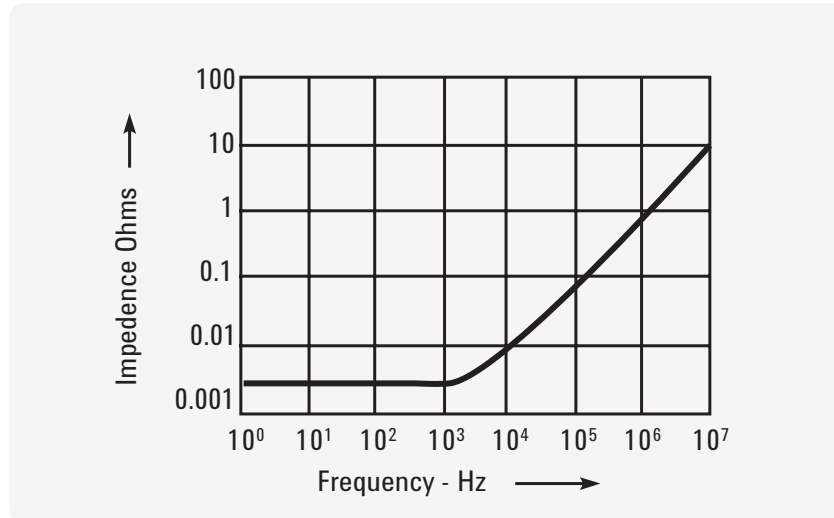

Typical output impedance of a constant voltage power supply

Output impedance: at any frequency of load change, $\Delta E_{out}/\Delta I_{out}$. Strictly speaking, the definition applies only for a sinusoidal load disturbance, unless the measurement is made at zero frequency (DC). The output impedance of an ideal constant voltage power supply would be zero at all frequencies, while the output impedance for an ideal constant current power supply would be infinite at all frequencies.

Overcurrent protection: protection of the power supply, electronic load and/or connected equipment against excessive output current.

Overvoltage protection: protection of the power supply, electronic load and/or connected equipment against excessive output voltage. Overvoltage protection is usually by means of a crowbar protection circuit, which rapidly places a low resistance shunt across the supply's output terminals to reduce output voltage to a low value if a predetermined voltage is exceeded. A supply equipped with an overvoltage crowbar must also be protected by a means for limiting or interrupting the output current.

Peak-to-peak noise: is the range between maximum and minimum noise level. Sometimes called noise "spikes." Peak-to-peak noise is typically low in energy and does not show up in a RMS measurement, 20-20 Mhz.

Phase angle: specifies the time domain phase relationship between two sine waves. The unit of phase angle is the degree, with one cycle corresponding to 360 degrees of phase.

Programming speed: the maximum time required for the programmed output voltage or current to change from a specified initial value (usually zero or maximum output) to a value within a specified tolerance band of a specified newly programmed value (for most models 99.9% or 0.1% of maximum output, respectively) following the onset of a step change in an analog programming signal, or the gating of a digital signal.

Readback: the ability of a power supply or electronic load to measure its actual output voltage and/or current, and provide the reading to a computer.

Remote sensing: remote sensing, or remote error sensing, is a means by which a power supply or electronic load monitors the stabilized voltage directly at the load or source respectively, using extra sensing leads. The resulting circuit action compensates for voltage drops up to a specified limit in the load leads.

Resolution: for a bench supply, the smallest change in output voltage or current that can be obtained using the front panel controls. For a system supply or electronic load, the smallest change that can be obtained using either the front panel controls, or a computer.

Reverse voltage protection: protection of the power supply or electronic load against reverse voltage applied at the output or input terminals.

RI (discrete fault indicator/remote inhibit): a rear-panel port that can be used to disable the power supply output independently of the GPIB. This port can also be used to chain multiple power supplies together such that an emergency shutdown of one output automatically signals the other supplies to disable their outputs.

Ripple and noise (dB): a term often used to specify rms or peak AC source noise relative to the maximum rms or peak output rating. The specification is calculated as follows: $\text{dB} = 20 \text{ Log} (V_{\text{noise}}/V_{\text{rating}})$.

Rms (or effective) amplitude or noise: an average signal or noise level based on energy content. The root mean square (rms) content is often called the AC component.

SCPI (Standard Commands for Programmable Instruments): is a programming language for controlling instrument functions over the GPIB (IEEE 488) instrument bus. The same SCPI commands and parameters control the same functions in different classes of instruments.

Serial link: a means by which up to 16 power supplies with this feature can share one GPIB primary address. The power supplies can be connected with cables similar to U.S. modular telephone cables. They are independently controlled using GPIB secondary addressing.

Series regulation: power supplies designed with this topology have fast programming speeds and low noise. Also referred to as a “linear” topology.

Slave operation: see “master-slave operation”.

Slew rate: for any given electronic load input transition, the change in current or voltage over time.

Source effect: also known as “line regulation”, source effect is the change in the steady-state value of the stabilized output or input voltage or current resulting from any change in the AC source voltage within its specified range, with all other influence quantities maintained constant. Source effect may be measured at any output or input voltage and current within rating.

Specifications: describe the power supply or electronic load warranted performance.

Supplemental characteristics: give typical but nonwarranted performance parameters.

Switching regulation supplies: power supplies designed with this topology are efficient and can have laboratory-grade specifications.

Temperature effect coefficient: the maximum steady-state change in a power supply’s output voltage or current or electronic load’s input voltage or current per degree Celsius following a change in the ambient temperature within specified limits, with all other influence quantities maintained constant.

Total harmonic distortion: the ratio of the rms sum of the harmonic components to the rms value of a periodic waveform. This is typically expressed as a percent or in decibels (dB).

Voltage limiting: the action of limiting the output voltage of a constant-current supply to some predetermined maximum value (fixed or adjustable) and automatically restoring the output current to its normal value when the load conditions are restored to normal. There are two types of voltage limiting:

- by constant voltage/constant current crossover
- by decreasing the output current as the voltage increases

Warm-up time: the time interval from when a power supply or electronic load is turned on until its output complies with all performance specifications.

Agilent Model Number Index

Agilent Model Number	Page Number	Agilent Model Number	Page Number
14565B	130	6651A	55
6030A	24	6652A	55
6031A	24	6653A	55
6032A	24	6654A	55
6033A	24	6655A	55
6035A	24	6671A	79
6038A	24	6672A	79
6060B	166	6673A	79
6063B	166	6674A	79
6541A	52	6675A	79
6542A	52	6680A	90
6543A	52	6681A	90
6544A	52	6682A	90
6545A	52	6683A	90
6551A	59	6684A	90
6552A	59	6690A	92
6553A	59	6691A	92
6554A	59	6692A	92
6555A	59	6811B	171
6571A	86	6812B	171
6572A	86	6813B	171
6573A	86	66000A	114
6574A	86	66001A	114
6575A	86	66002A	114
6611C	45	66101A	114
6612C	45	66102A	114
6613C	45	66103A	114
6614C	45	66104A	114
6621A	97	66105A	114
6622A	97	66106A	114
6623A	97	66309B/D	125
6624A	97	66311B	125
6625A	99	66319B/D	125
6626A	99	66321B/D	125
6627A	97	66332A	125
6628A	99	B1500A	154
6629A	99	B1505A	156
6631B	47	B1510A	154, 156
6632B	47	B1511A	154
6633B	47	B1512A	156
6634B	47	B1513A	156
6641A	49	B1517A	154
6642A	49	B1520A	154, 156
6643A	49	B1525A	154
6644A	49	B1530A	154
6645A	49	B2901A	140

More detailed specifications at www.agilent.com/find/power

Agilent Model Number Index (Continued)

Agilent Model Number	Page Number	Agilent Model Number	Page Number
B2902A	140	N5744A	27
B2911A	140	N5745A	27
B2912A	140	N5746A	27
B2961A	94	N5747A	29
B2962A	94	N5748A	29
E3620A	18	N5749A	29
E3630A	18	N5750A	29
E3631A	19	N5751A	29
E3632A	20	N5752A	29
E3633A	20	N5761A	30
E3634A	20	N5762A	30
E3640A	22	N5763A	30
E3641A	22	N5764A	30
E3642A	22	N5765A	30
E3643A	22	N5766A	30
E3644A	22	N5767A	31
E3645A	23	N5768A	31
E3646A	23	N5769A	31
E3647A	23	N5770A	31
E3648A	23	N5771A	31
E3649A	23	N5772A	31
E4356A	84	N6700B	113
E4360A	132	N6701A	113
E4361A	132	N6702A	113
E4362A	132	N6705B	118
E5260A	146	N6731B	110, 118
E5262A	148	N6732B	110, 118
E5263A	150	N6733B	110, 118
E5270B	152	N6734B	110, 118
E5280B	152	N6735B	110, 118
E5281B	152	N6736B	110, 118
E5287A	152	N6741B	112, 118
E5288A	152	N6742B	112, 118
E5290A	146, 150	N6743B	112, 118
E5291A	146, 148, 150	N6744B	112, 118
N3300A	159	N6745B	112, 118
N3301A	159	N6746B	112, 118
N3302A	159	N6751A	101, 118
N3303A	159	N6752A	101, 118
N3304A	159	N6753A	101, 118
N3305A	159	N6754A	101, 118
N3306A	159	N6755A	101, 118
N3307A	159	N6756A	101, 118
N5741A	27	N6761A	104, 119
N5742A	27	N6762A	104, 119
N5743A	27	N6763A	104, 119

More detailed specifications at www.agilent.com/find/power

Agilent Model Number Index (Continued)

Agilent Model Number	Page Number	Agilent Model Number	Page Number
N6764A	104, 119	N8740A	34
N6765A	104, 119	N8741A	34
N6766A	104, 119	N8742A	34
N6773A	108, 118	N8754A	35
N6774A	108, 118	N8755A	35
N6775A	108, 118	N8756A	35
N6776A	108, 118	N8757A	35
N6777A	108, 118	N8758A	35
N6781A	119, 137	N8759A	36
N6782A	119, 137	N8760A	36
N6783A-BAT	119, 122	N8761A	36
N6783A-MFG	122	N8762A	36
N6784A	119, 137	N8920A	37
N6950A	63	N8921A	37
N6951A	63	N8923A	37
N6952A	63	N8924A	37
N6953A	63	N8925A	39
N6954A	63	N8926A	39
N6970A	66	N8928A	39
N6971A	66	N8929A	39
N6872A	66	N8930A	39
N6973A	66	N8931A	41
N6974A	66	N8932A	41
N6976A	75	N8934A	41
N6977A	75	N8935A	41
N7950A	69	N8937A	41
N7951A	69	N8940A	37
N7952A	69	N8941A	37
N7953A	69	N8943A	37
N7954A	69	N8944A	37
N7970A	72	N8945A	39
N7971A	72	N8946A	39
N7972A	72	N8948A	39
N7973A	72	N8949A	39
N7974A	72	N8950A	39
N7976A	75	N8951A	41
N7977A	75	N8952A	41
N8731A	32	N8954A	41
N8732A	32	N8955A	41
N8733A	32	N8957A	41
N8734A	32	U2722A	142
N8735A	32	U2723A	142
N8736A	32	U8001A	16
N8737A	34	U8002A	16
N8738A	34	U8031A	16
N8739A	34	U8032A	16

More detailed specifications at www.agilent.com/find/power

Agilent Replacement Guide

Index for Obsolete Agilent System and Bench Products

* These products are closest in ratings to the discontinued model, but are not identical. Refer to the catalog for the features and specifications of the suggested alternative products.

Obsolete Model Number	Closest Alternatives*	Obsolete Model Number	Closest Alternatives*
6002A	664xA	6267B	6553A
6010A	6030A	6268B	6574A
6011A	6031A	6269B	6573A
6012B	6032A	6271B	6544A
6015A	6035A	6274B	6574A
6023A	6033A	6281A	U8002A
6024A	6038A	6282A	6542A
6028A	6038A	6284A	U8001A
6034A	6038A	6286A	6542A
6050A	N3300A	6289A	U8001A or E3643A
6051A	N3301A	6291A	6543A
6200B	U8001A or E3643A	6294A	E3643A
6201B	U8001A or E3643A	6296A	6544A
6202B	U8001A or E3643A	6299A	6634B or (2) E3643A
6203B	U8002A	6384A	6542A
6204B	E3643A	6427B	6552A
6205C	(2) U8001A or (2) E3641A	6428B	6011A
6206C	E3643A	6433B	6012B
6211A	E3641A or 6614C	6434B	6012B
6212C	E3641A or 6614C	6438B	6544A, 6634B
6213A	U8001A	6439B	6012B
6214C	U8001A	6448B	6015A
6215A	U8001A or E3641A	6453B	(2) 6572A
6216C	U8001A or E3641A	6456B	(2) 6572A
6217A	E3641A or 6614C	6459A	(2) 6573A
6218C	E3641A or 6614C	6464C	(2) 6681A
6220B	E3643A	6466C	(2) 6681A
6224B	6453A	6612B	6612C
6226B	6544A	6632A	6632B
6227B	(2) U8001A or (2) E3643A	6633A	6633B
6228B	(2) E3643A	6634A	6634B
6234A	E3620A	6814A/B	6813B
6235A	E3630A	6834A/B	6813B
6236B	E3630A	60501B	N3302A
6237B	E3620A and U8001A or E3641A	60502B	N3304A
6253A	(2) U8001A	60503B	N3303A
6255A	(2) U8001A or (2) E3643A	60504B	N3306A
6256B	E6552A	60507B	N3305A
6259B	6572A	66111A	66311B
6260B	6572A	66311A	66311B
6261B	6573A	66311D	66321D
6263B	6542A	E3610A	U8001A
6264B	6552A	E3611A	U8001A or E3641A
6265B	6554A	E3612A	E3641A or 6614C
6266B	6543A	E3614A	U8002A

More detailed specifications at www.agilent.com/find/power

Agilent Replacement Guide (continued)

Index for Obsolete Agilent System and Bench Products

Obsolete Model Number	Closest Alternatives*
E3615A	U8001A
E3616A	U8001A or E3643A
E3617A	E3643A
E4350A	E4360A
E4350B	E4360A
E4351B	E4360A
N6705A	N6705B

* These products are closest in ratings to the discontinued model, but are not identical. Refer to the catalog for the features and specifications of the suggested alternative products.



myAgilent

www.agilent.com/find/myagilent

A personalized view into the information most relevant to you.



AdvancedTCA® Extensions for Instrumentation and Test (AXIe) is an open standard that extends the AdvancedTCA for general purpose and semiconductor test. Agilent is a founding member of the AXIe consortium.

www.lxistandard.org



LAN eXtensions for Instruments puts the power of Ethernet and the Web inside your test systems. Agilent is a founding member of the LXI consortium.

www.pxisa.org



PCI eXtensions for Instrumentation (PXI) modular instrumentation delivers a rugged, PC-based high-performance measurement and automation system.

Three-Year Warranty



www.agilent.com/find/ThreeYearWarranty

Beyond product specification, changing the ownership experience. Agilent is the only test and measurement company that offers three-year warranty on all instruments, worldwide.



Agilent Assurance Plans

www.agilent.com/find/AssurancePlans

Five years of protection and no budgetary surprises to ensure your instruments are operating to specifications and you can continually rely on accurate measurements.



www.agilent.com/quality



Agilent Electronic Measurement Group
 DEKRA Certified ISO 9001:2008
 Quality Management System

Agilent Channel Partners

www.agilent.com/find/channelpartners

Get the best of both worlds: Agilent's measurement expertise and product breadth, combined with channel partner convenience.

Bluetooth and the Bluetooth logos are trademarks owned by BluetoothSIG, Inc., USA, and licensed to Agilent Technologies, Inc.

Microsoft® and Windows® are U.S. registered trademarks of Microsoft® Corporation.

LabVIEW™ is a U.S. registered trademark of National Instruments Corporation.

For more information on Agilent Technologies' products, applications or services, please contact your local Agilent office. The complete list is available at: www.agilent.com/find/contactus

Americas

Canada	(877) 894 4414
Brazil	(11) 4197 3600
Mexico	01800 5064 800
United States	(800) 829 4444

Asia Pacific

Australia	1 800 629 485
China	800 810 0189
Hong Kong	800 938 693
India	1 800 112 929
Japan	0120 (421) 345
Korea	080 769 0800
Malaysia	1 800 888 848
Singapore	1 800 375 8100
Taiwan	0800 047 866
Other AP Countries	(65) 375 8100

Europe & Middle East

Belgium	32 (0) 2 404 93 40
Denmark	45 45 80 12 15
Finland	358 (0) 10 855 2100
France	0825 010 700* *0.125 €/minute
Germany	49 (0) 7031 464 6333
Ireland	1890 924 204
Israel	972-3-9288-504/544
Italy	39 02 92 60 8484
Netherlands	31 (0) 20 547 2111
Spain	34 (91) 631 3300
Sweden	0200-88 22 55
United Kingdom	44 (0) 118 927 6201

For other unlisted countries:

www.agilent.com/find/contactus

(BP-01-15-14)

Product specifications and descriptions in this document subject to change without notice.

© Agilent Technologies, Inc. 2014
 Published in USA, April 1, 2014
 5989-8959EN

